

LAMARI™ 0.5 / 1 / 2 / 3 / 4 SC

Our linear LED fixture is the ideal choice for professional lighting, offering outstanding color mixing. For enhanced safety, the fixture operates at 48V and is controlled via DALI 2 and E-Box Remote series controllers. The fixture's body is made from durable aluminum, boasting IK10 and IP67 ratings, ensuring high resistance to mechanical damage and harsh weather conditions. A wide range of beam angles is available, allowing precise adjustment to meet specific project requirements. The fixture is available in four length variants and offers multiple surface mounting options.



KEY FEATURES

Optic & Control

Advanced technology ensures precise blending of colours. Choose from a variety of beam angles to suit different lighting needs. 48V operation for safe usage in various environments.

Compact design

At only 39 mm of total height, Lamari SC has been designed as a compact and slim LED luminaire suitable for any low-profile application. Available in four length options with multiple mounting configurations.

Durability

Thanks to its tempered glass and high-pressure, extruded aluminum housing, Lamari SC is IK10 and IP67 certified. For more extreme and marine applications, a harsh environment finish option is also available.

CONTROL & PROTOCOLS



REMOTE



REMOTE

STANDARD & SPECIFICATION



Warranty with Registration

Vibration Standard for Bridge

FINISH OPTIONS

* CLOSEST RAL TONE
* HE = Harsh Environment



Graphite Black
RAL 9011*



Grey Aluminium
RAL 9007



Sandstone
RAL 1014*



Pure White
RAL 9010



HE Graphite Black
RAL 9011*



HE Grey Aluminium
RAL 9007



HE Sandstone
RAL 1014*



HE Pure White
RAL 9010



Custom Paint Colour

COLOURS

STANDARD



PW
(3000 K)



TW
(2200-3000 K)

UPON REQUEST

AVAILABLE COLOURS FOR CUSTOM SETUP



2.200 K



2.700 K



4.000 K



6.500 K

OPTIC OPTIONS

SYMMETRICAL



12°



15°



25°



35°



50°



70°



105°

BI-SYMMETRICAL



10°x20°



10°x40°



10°x80°



15°x45°



15°x90°



40°x90°



35°x110°

SPECIFICATION

ELECTRICAL	Input Voltage	48 V			
	Typical Power Consumption	Lamari SC 0.5: 5 W	Lamari SC 1: 10 W		
		Lamari SC 2: 20 W	Lamari SC 3: 30 W		
		Lamari SC 4: 40 W			
OPTICAL	Light Source	Lamari SC 0.5 / 1 / 2 / 3 / 4: 4 / 8 / 16 / 24 / 32 High Power LEDs			
	Colour Variants	Pure White (W - 3000 K) Tuneable White (2200–3000 K)			
		Custom Setup On Request: 2200 K, 2700 K, 4000 K, 6500 K			
	Beam Angle	Without Linear Louvre	Symmetrical:	12° 15° 25° 35° 50° 70° 105°	
			Bi-symmetrical:	10°x20° 10°x40° 10°x80° 15°x45° 15°x90° 35°x110° 45°x65°	
		With Linear Louvre <small>*Low Glare Accessories</small>	Symmetrical:	12° 15° 25°	
			Bi-symmetrical:	10°x20° 10°x40° 10°x80° 15°x45° 15°x90° 35°x110°	
	Lumen Output Delivered	Lamari SC 0.5: 296 lm, (SC, PW 2700K) TBC		Lamari SC 1: 591 lm, (SC, PW 2700K) TBC	
		Lamari SC 2: 1274 lm, (SC, TW @3000K) TBC		Lamari SC 3: 1911 lm, (SC, TW @3000K) TBC	
		Lamari SC 4: 2548 lm, (SC, TW @3000K) TBC			
Projected Lumen Maintenance	L90B10 >90.000 hrs, Ta = 25°C / 77°F				
CONTROL	Interface Protocol	Via E-Box Remote range, DALI 2			
	E-Box Remote Control Protocols	USITT DMX512, RDM, ArtNet, MA Net, MA Net2, sACN, Kling-Net			
	Operating Modes	Pixel (per 1/2 Foot) or Fixture mode			
	Setting / Addressing	Via Two Row LCD Display with Control Buttons on E-Box Remote or RDM communicator			
	Power Supply	Via E-Box Remote range			
	Connectivity	E-box Remote E-box Remote Basic			
PHYSICAL	Width x Height x Length		Rear:	Side:	
		Lamari SC 0.5	37 x 39 x 185 mm (1.46 x 1.54 x 7.28 in.)	37 x 39 x 185 mm (1.46 x 1.54 x 7.28 in.)	
		Lamari SC 1	37 x 39 x 339 mm (1.46 x 1.54 x 13.4 in.)	37 x 39 x 339 mm (1.46 x 1.54 x 13.4 in.)	
		Lamari SC 2	37 x 39 x 647 mm (1.46 x 1.54 x 25.5 in.)	37 x 39 x 647 mm (1.46 x 1.54 x 25.5 in.)	
		Lamari SC 3	37 x 39 x 956 mm (1.46 x 1.54 x 37.6 in.)	37 x 39 x 956 mm (1.46 x 1.54 x 37.6 in.)	
		Lamari SC 4	37 x 39 x 1264 mm (1.46 x 1.54 x 49.8 in.)	37 x 39 x 1264 mm (1.46 x 1.54 x 49.8 in.)	
	Weight 0.5 / 1 / 2 / 3 / 4	0.5 kg (1.1 lbs) / 0.9 kg (2.0 lbs) / 1.6 kg (3.5 lbs) / 2.2 kg (4.9 lbs) / 2.8 kg (6.2 lbs)			
	Housing	High Pressure Extruded Aluminium Body End Caps – Die-Cast Aluminium Tempered Glass			
	Finish Options	Standard Colour	Graphite Black RAL 9011* Grey Aluminium RAL 9007 Pure White RAL 9010 Sandstone RAL 1014* <small>*Closest RAL Tone</small>		
		Standard Colour Harsh Environment	Graphite Black RAL 9011* Grey Aluminium RAL 9007 Pure White RAL 9010 Sandstone RAL 1014* <small>*Closest RAL Tone</small>		
Cost Option		Custom RAL			
Cables/Connections	IP67 Hybrid Connection (Power + Data)				
Mounting Method	Surface Mount With Different Type of Brackets				
Adjustability	+10° (With Standard Mounting Bracket)				
Protection Factor IK Rating	IP67 / Suitable For Wet Locations IK10				
Cooling System	Convection				
Operating Ambient Temperature	-20°C / +40°C (-4°F / +104°F)				
Operating Temperature	+67°C @ Ambient +40°C (+153°F @ Ambient +104°F)				
CERTIFICATION	Listings	ETL / cETL, CE, RoHS, UKCA			

SPECIFICATION

CABLES AND CONNECTORS	Not Included Items	Leader Cable FF, 0.1 m, CE AD-05
		Jumper Cable CE/US MID-05 FF/MM (14 AWG) 0.5 m 1 m 3 m 5 m
		Jumper Cable MINI-05 FF/MM (20 AWG), 0.5 m 1 m 3 m 5 m
		T-connector MID-05 MFF
		Connector T MINI-05 MFF
		Adaptor MID2MINI
		Cable SJTW 5x14 AWG black
		Cable SJTW 5x14 AWG white

LAMARI INPUT OPTIONS

STANDARD

UPON REQUEST

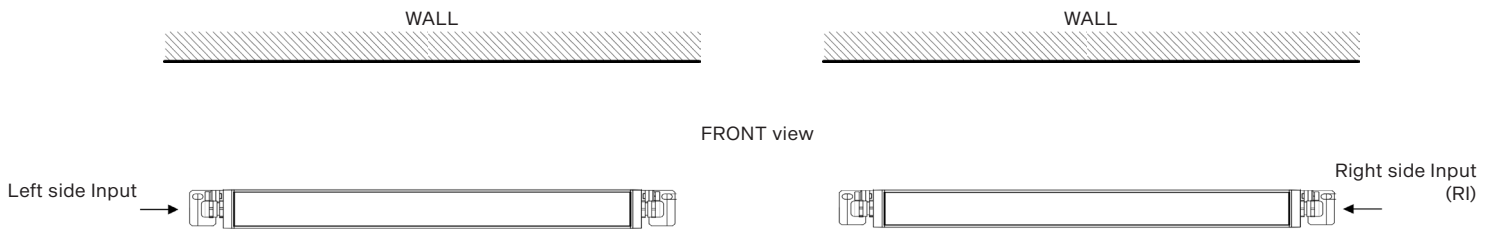

DISTANCE FROM THE WALL

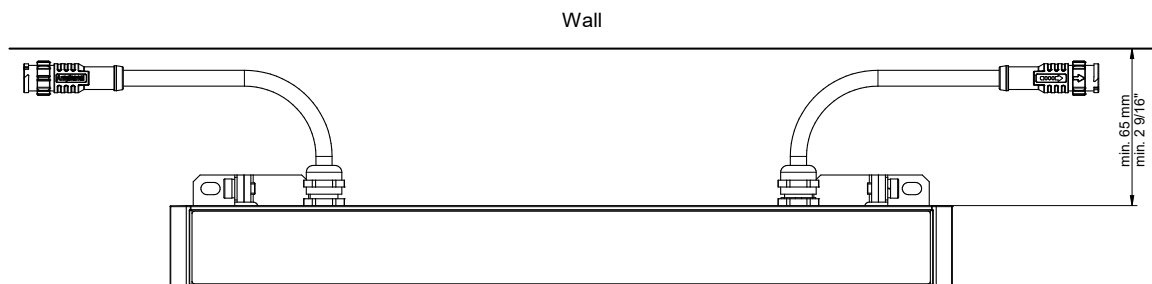

CONTROL AND CONNECTION OPTIONS

STANDARD

- 1) Leader Cable FF, 0.1 m, CE AD-05 (13053978)
- 2) Cable 5x20 AWG, 0.1 m, with connector MM
- 3) Cable 5x20 AWG, 0.5 m, with connector FF

Note: The last unplugged connector must be fitted with a Waterproof Cap to protect the IP rating.

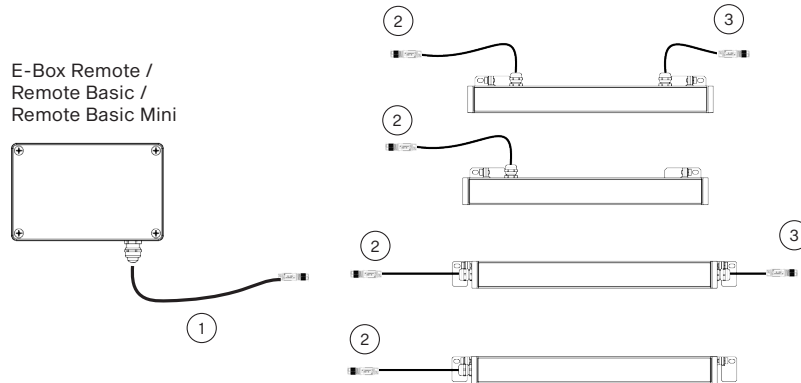

STANDARD WITH JUMPER CABLE

- 1) Leader Cable FF, 0.1 m , CE AD-05 (13053978)
- 2) Cable 5x20 AWG, 0.1 m, with connector MM
- 3) Cable 5x20 AWG, 0.5 m, with connector FF
- 4) Jumper Cable MM/FF - 0.5 m | 1 m | 3 m | 5 m

Note: The last unplugged connector must be fitted with a Waterproof Cap to protect the IP rating.

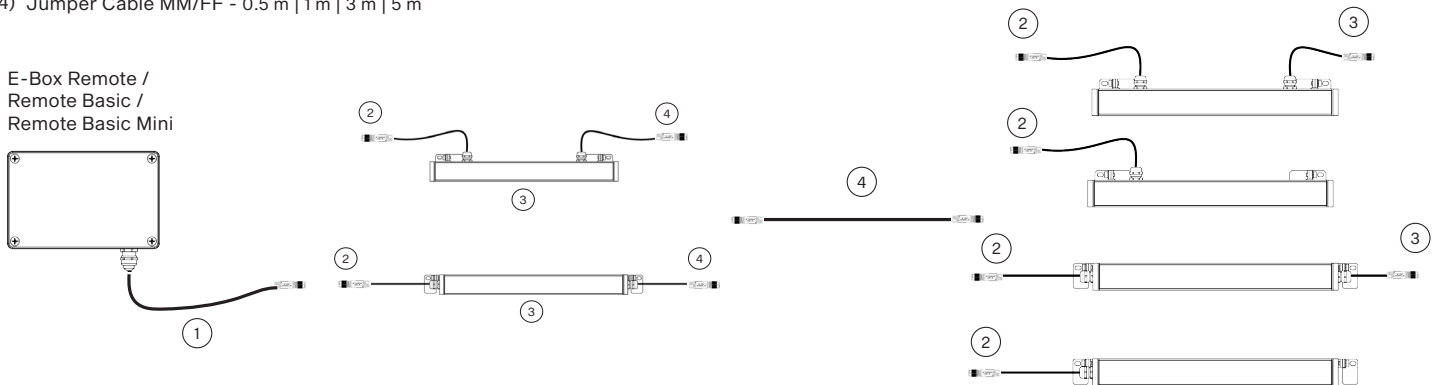

DALI VERSION (CE)

- 1) Junction Box Remote with 5x20 AWG, 0.1 m, with connector FF
- 2) Cable 5x20 AWG, 0.5 m, with connector MM
- 3) Cable 5x20 AWG, 0.1 m, with connector FF

Note: The last unplugged connector must be fitted with a Waterproof Cap to protect the IP rating.

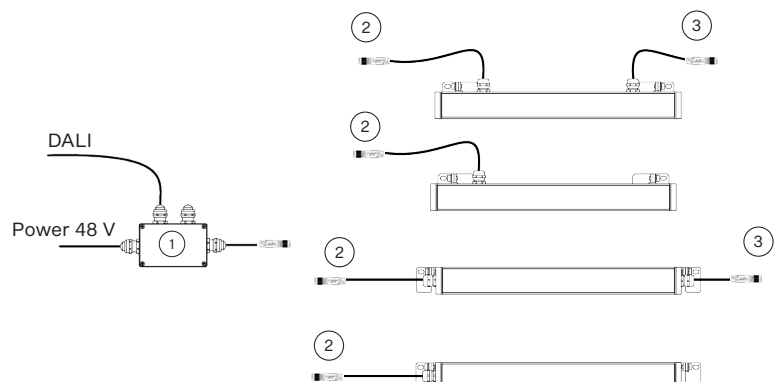

CONTROL AND CONNECTION OPTIONS

DMX WITH CONNECTION BOX FOR LAMARI

A

- 1) SJTW 5x14 AWG (13053336), standard with bare-end, black or Cable SJTW 5x14 AWG (13053697), with bare-end, white (on request)
- 2) Field Installable Connector MID-05 MM (14-22 AWG) - (13054126)
- 3) T-connector MID-05 MFF (13054130)
- 4) Jumper Cable CE/US MID-05 FF/MM (5x14 AWG), 0.5 m (13054131)
- 5) Adaptor MID2MINI (13054149)
- 6) Cable 5x20 AWG, 0.1 m, with connector MM
- 7) Cable 5x20 AWG, 0.5 m, with connector FF

Note: The last unmated connector must be fitted with an Waterproof Cap to protect the IP rating.

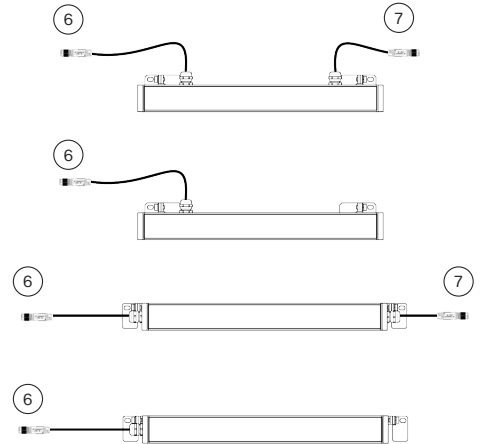
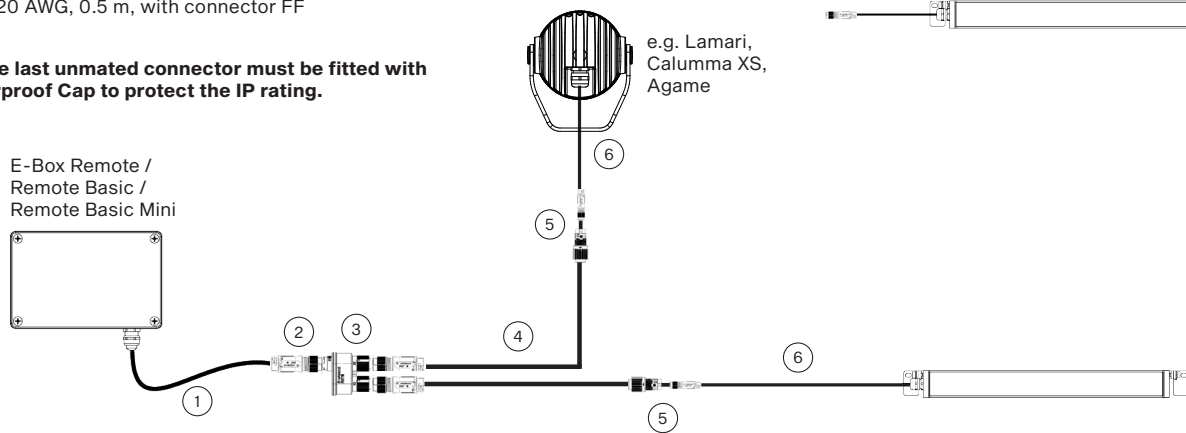

B

- 1) SJTW 5x14 AWG (13053336), standard with bare-end, black or Cable SJTW 5x14 AWG (13053697), with bare-end, white (on request)
- 2) Adaptor MID2MINI (13054149)
- 3) Jumper Cable MINI-05 FF/MM (20 AWG), 0.5 m (13053937-02)
- 4) Connector T MINI-05 MFF (13053941-01)
- 5) Cable 5x20 AWG, 0.1 m, with connector MM
- 6) Cable 5x20 AWG, 0.5 m, with connector FF

Note: The last unmated connector must be fitted with an Waterproof Cap to protect the IP rating.

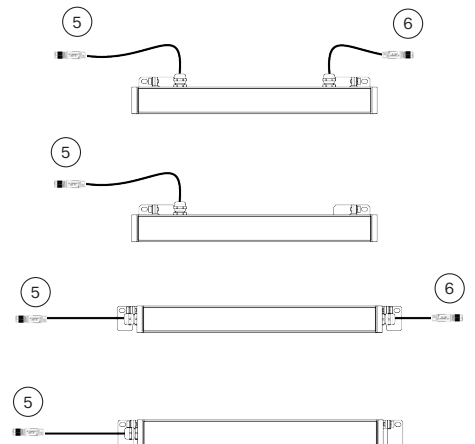
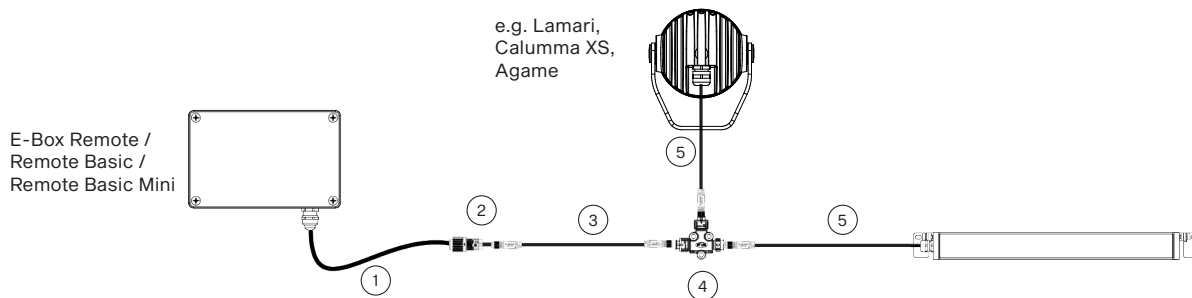

LAMARI CABLE ENTRY OPTIONS

Rear IN/OUT Version



Rear IN Version



Side IN/OUT Version



Side IN Version



DIMENSIONS

Rear IN/OUT Version

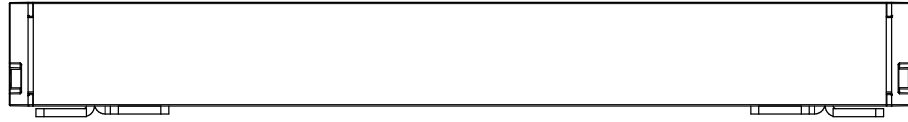
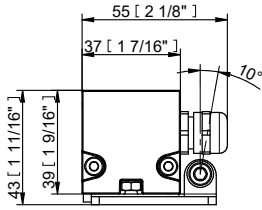

Wall

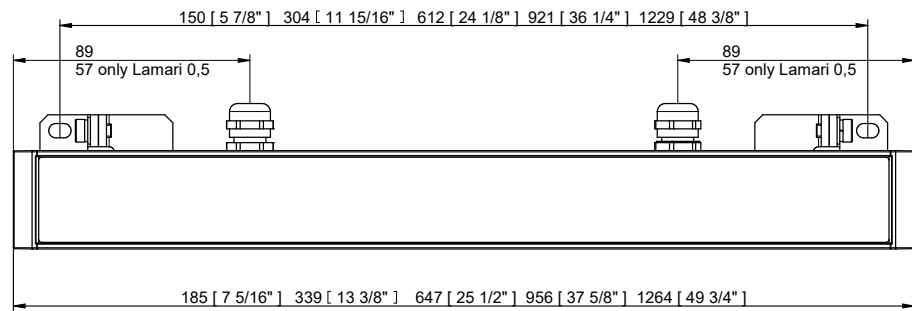

Rear IN Version

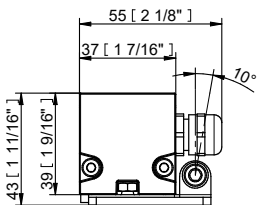

Wall

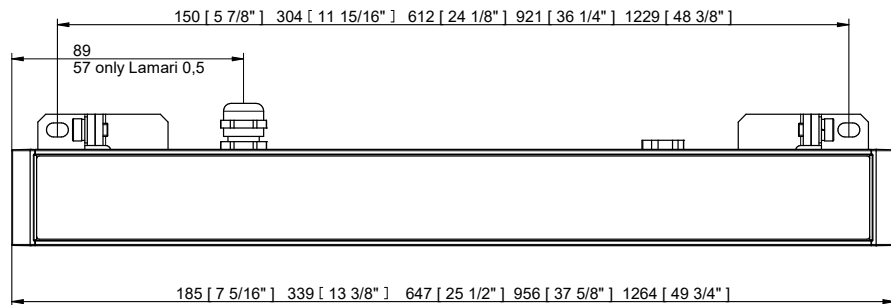

Side IN/OUT Version

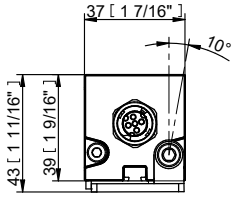

Wall

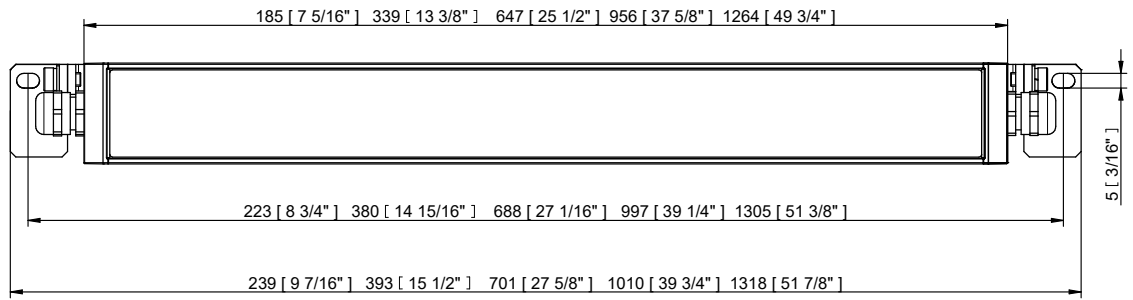

Side IN Version

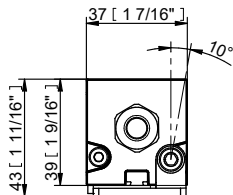

Wall

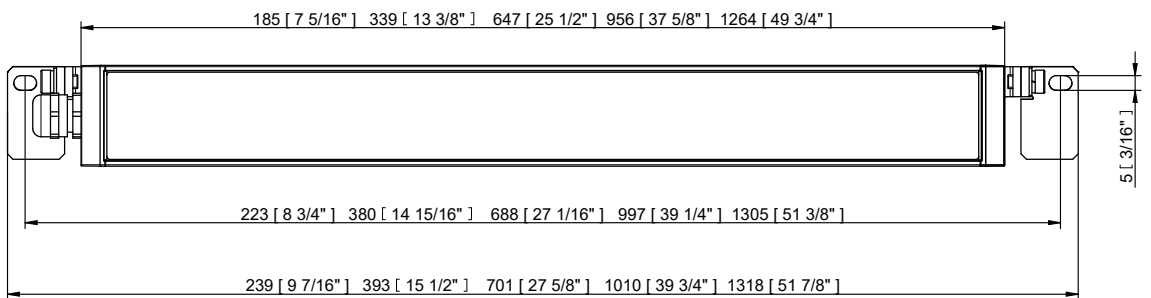

ACCESSORIES

Barndoors for Lamari Side

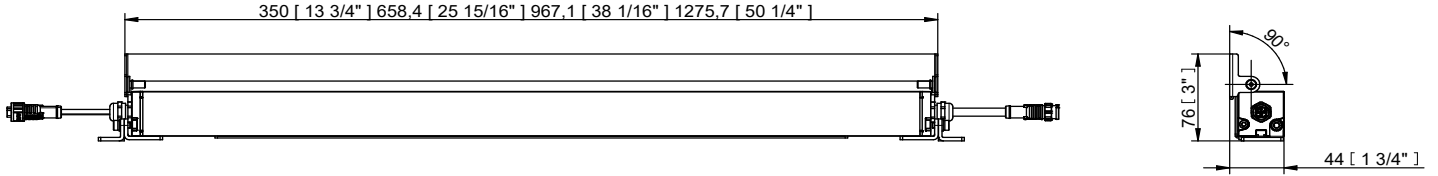

Barndoors for Lamari Rear

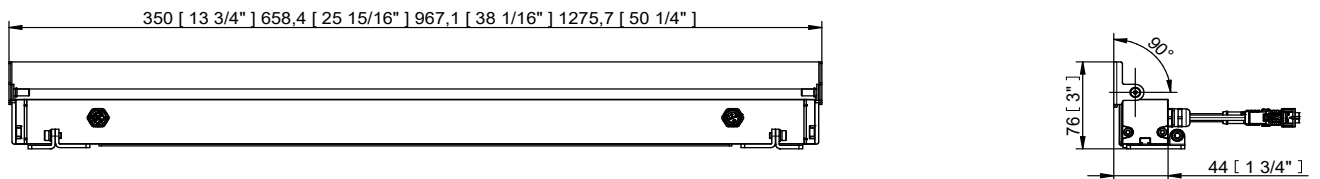

Shields for Lamari Side

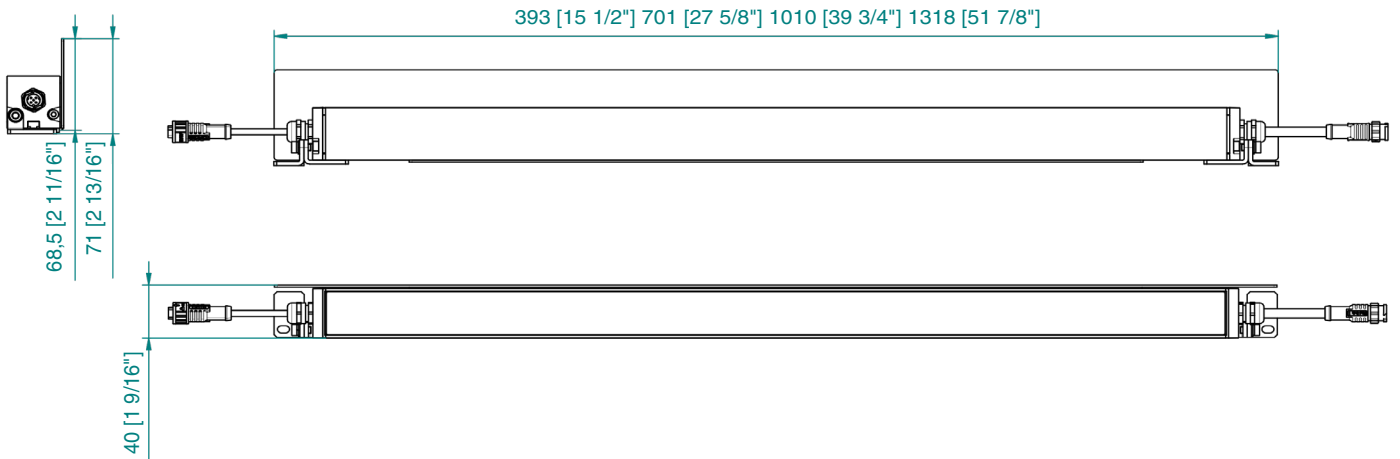

Shields for Lamari Rear

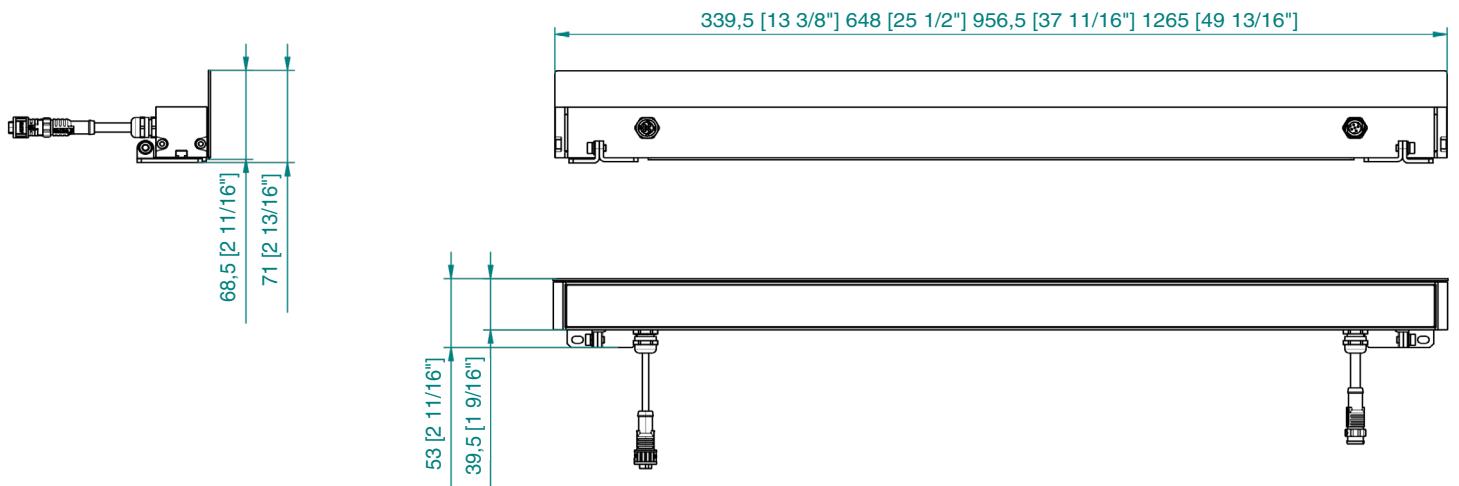

Wall Mount Brackets

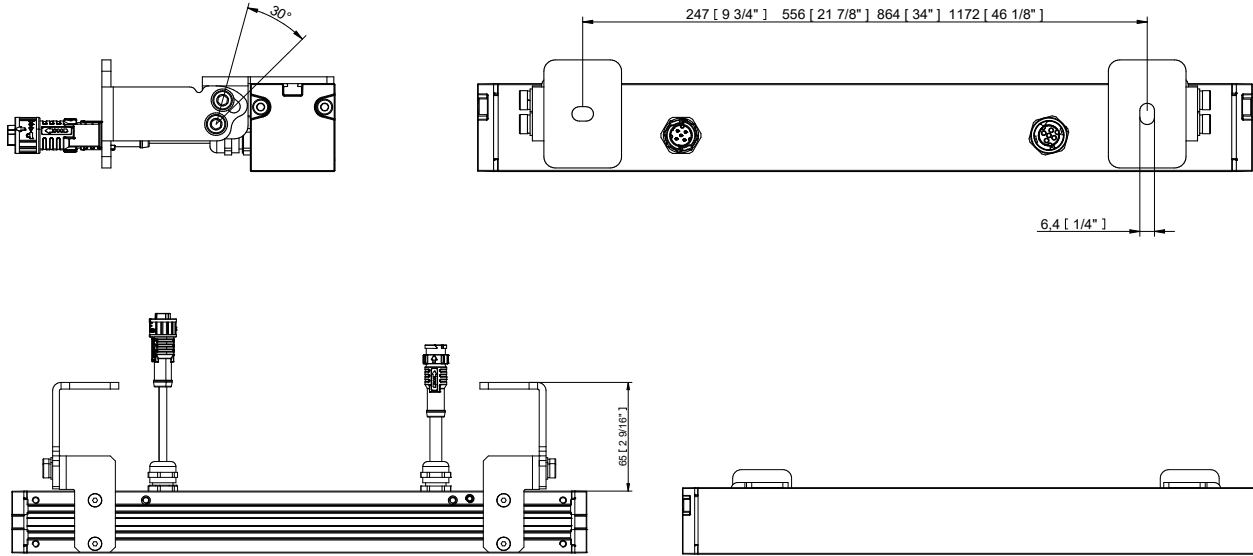

Wall Mount Scissors Brackets

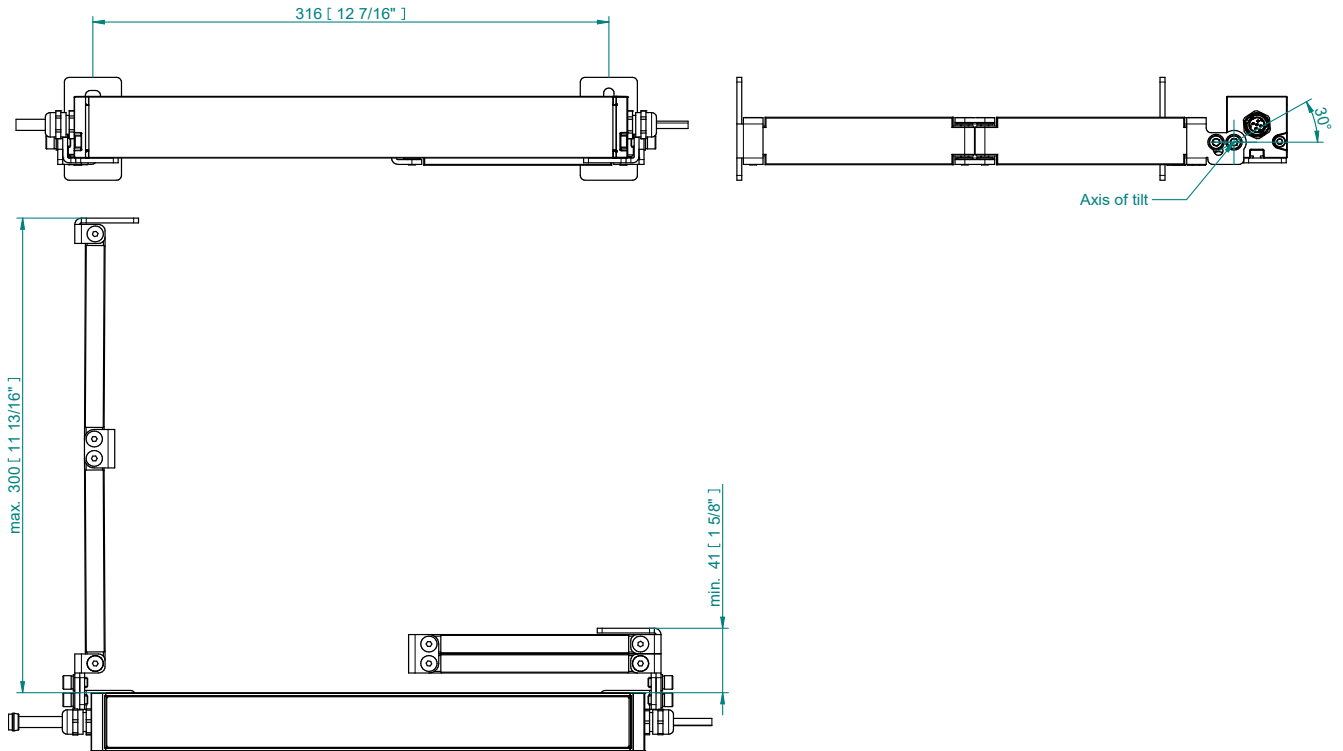

BI-SYMMETRICAL BEAM ANGLES

Bi-symmetrical: 15°x40°, 15°x70°, 20°x45°, 20°x80°, 35°x110°, 40°x65°

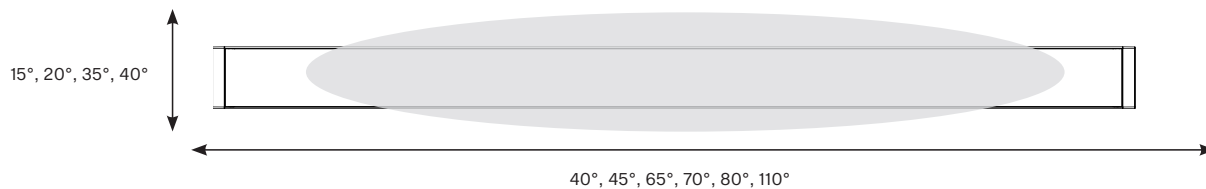

PHOTOMETRIC DATA

Lamari SC 4 TW (2200K–3000K)
12dg set to 3000K

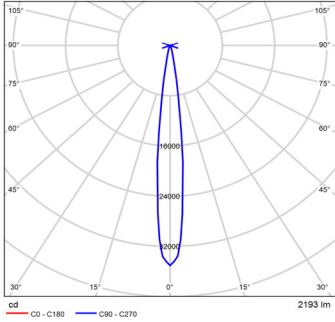

Lamari SC 4 TW (2200K–3000K)
15dg set to 3000K

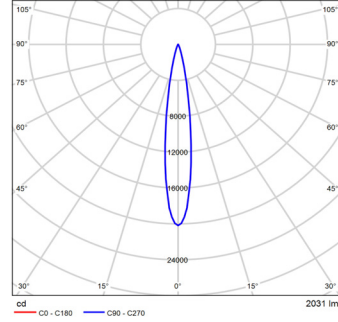

Lamari SC 4 TW (2200K–3000K)
25dg set to 3000K

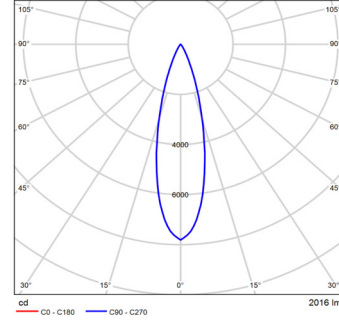

Lamari SC 4 TW (2200K–3000K)
35dg set to 3000K

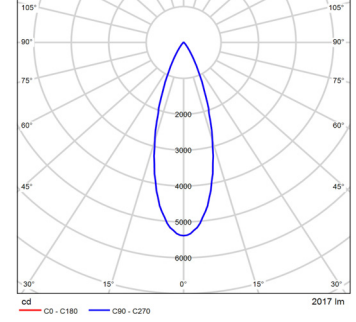

Lamari SC 4 TW (2200K–3000K)
50dg set to 3000K

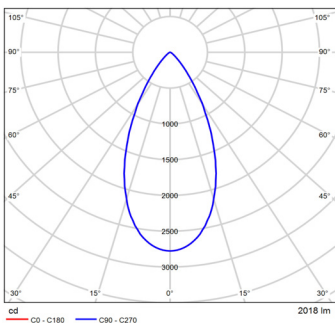

Lamari SC 4 TW (2200K–3000K)
70dg set to 3000K

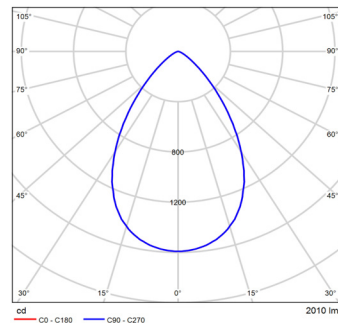

Lamari SC 4 TW (2200K–3000K)
105dg set to 3000K

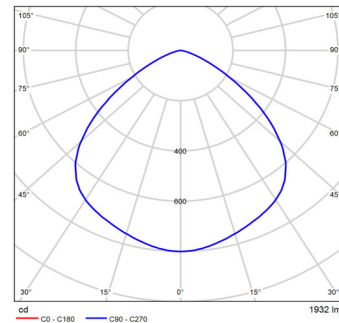

Lamari SC 4 TW (2200K–3000K)
10dg x 20dg set to 3000K

