

EMINERE® SIDE 1 / 2 / 3 / 4

Eminere Side is specifically designed for applications where a low form factor is required whilst keeping installation of the luminaire neat and clean. With only 76 mm in height, it keeps all of the Eminere series strengths. Wide range of optics options, durability, connectivity, application flexibility make this luminaire ideal solution for flood lighting, wall grazing, wall washing and accent lighting.



KEY FEATURES

Quick and Easy Installation

Easy and quick installation using click-on connectors overmolded on combo cable (Power + Data).

Durability

High durability of IK06 in combination of ingress factor IP67.

Application Flexibility

Complete solution for illuminating buildings, monuments, walls, statues, bridges, covers, arches and much more. With PSU on its side, Eminere Side is only 76 mm in height.

Optics & Colours

Wide range of optics allows to place product anywhere needed with no limitation. Full spectral LEDs selection with custom option on request. Output up to 1.147 lm (RGBW) or 1.652 lm (PW) per one foot of Eminere.

COLOURS

STANDARD



RGBW
(6500 K)



RGBA



PW
(3000 K)



TW
(2200-3000 K)

UPON REQUEST

AVAILABLE COLOURS
FOR CUSTOM SETUP



RED



GREEN



BLUE



AMBER



2.200 K



2.700 K



3.000 K



4.000 K



6.500 K

CONTROL & PROTOCOLS



VIA
E-BOX
OPTIONAL



WIRELESS
DMX
OPTIONAL



ON
OFF
PW & SINGLE
COLOR
ONLY



DALI
OPTIONAL

STANDARD & SPECIFICATION



IP67



IK06



CE



ETL



ROHS



UK
CA



5
YEAR

Warranty
with
Registration



VIBRATION
STANDARD
FOR BRIDGE

Vibration
Standard
for Bridge

OPTIC OPTIONS

SYMMETRICAL



9°



15°



30°



50°



65°



100°

BI-SYMMETRICAL



10°X30°



10°X60°



15°X90°



35°X70°



15°X45°

ASYMMETRICAL



WIDE
WALLWASHER



WALLWASHER

FINISH OPTIONS

* CLOSEST RAL TONE

All standard finish options are available in a harsh environment finish.



Graphite Black
RAL 9011*



Grey Aluminium
RAL 9007



Sandstone
RAL 1014*



Pure White
RAL 9010



RAL
Custom
Paint Colour

SPECIFICATION

ELECTRICAL	Input Voltage	120 - 277 V AC 50/60 Hz			
	Typical Power Consumption	Eminere Side 1: 25 W		Eminere Side 3: 65W	
		Eminere Side 2: 45W		Eminere Side 4: 85W	
OPTICAL	Light Source	Eminere Side 1: 12 x High Power Single Chip LEDs		Eminere Side 3: 36 x High Power Single Chip LEDs	
		Eminere Side 2: 24 x High Power Single Chip LEDs		Eminere Side 4: 48 x High Power Single Chip LEDs	
	Colour Variants	RGBW (W - 6500 K) RGBA Pure White (W - 3000 K) Tuneable White (2200–3000 K)			
		Custom Setup On Request: Red, Green, Blue, Amber, 2200 K, 2700 K, 3000 K, 4000 K, 6500 K			
	Beam Angle	Symmetrical:	9° 15° 30° 50° 65° 100°		
		Bi-symmetrical:	10° x 30° 10° x 60° 35° x 70° 15° x 90° 15° x 45°		
Asymmetrical:		Wallwasher Wide Wallwasher			
Lumen Output Delivered	Eminere Side 1: 1.147 lm, RGBW @ 9°		Eminere Side 3: 3.441 lm, RGBW @ 9°		
	Eminere Side 2: 2.294 lm, RGBW @ 9°		Eminere Side 4: 4.588 lm, RGBW @ 9°		
Projected Lumen Maintenance	L90B10 >90.000 hrs, Ta = 25°C / 77°F				
CONTROL	Interface Protocol	Via E-Box range, Wireless DMX (excluded Eminere Side 1), ON/OFF (PW & single color only, No dimming), DALI 2 (CE only)			
	E-Box Control Protocols	USITT DMX512, RDM, ArtNet, MA Net, MA Net2, sACN, Kling-Net			
	Wireless DMX (Option)	Lumen Radio CRMX Technology			
	Operating Modes	Pixel (12 LEDs/300mm) or Fixture mode			
	Setting / Addressing	Via Two Row LCD Display with Control Buttons or RDM communicator			
	Power Supply	Integrated			
	Connectivity	E-box Lite E-box Daisy	127 of Eminere Side 1 (@ 230 V and 30m cable) via 1 Output		
		E-box Star	127 of Eminere Side 1 (@ 230 V and 30m cable) via 6 Outputs		
PHYSICAL	Width x Height x Length	Eminere Side 1 / 2 / 3 / 4	148 x 76 x 329 / 629 / 929 / 1229 mm		
			5.82 x 2.99 x 12.95 / 24.76 / 36.57 / 48.38 in.		
	Weight	2.95 kg / 6.5 lbs	4.75 kg / 10.47 lbs	7 kg / 15.43 lbs	8.92 kg / 19.67 lbs
		High Pressure Extruded Aluminium Body			
	Housing	End Caps - Die-Cast Aluminium			
		Tempered Glass			
	Finish Options	Standard Colour	Graphite Black RAL 9011 Grey Aluminium RAL 9007 Pure White RAL 9010 Sandstone RAL 1014		
		Standard Colour Harsh Environment	Graphite Black RAL 9011 Grey Aluminium RAL 9007 Pure White RAL 9010 Sandstone RAL 1014		
		Cost Option	Custom RAL		
	Cables / Connections	IP67 Hybrid Connection (Power + Data)			
Mounting Method	Surface Mount With Different Type of Brackets				
Adjustability	-105° / +15°				
Protection Factor	IP67 / Suitable For Wet Locations				
IK Rating	IK06				
Cooling System	Convection				
Operating Ambient Temperature	-20 °C / +50 °C (-4 °F / +122 °F)				
Operating Temperature	+67 °C @ Ambient +50 °C (+153 °F @ Ambient +122 °F)				
CERTIFICATION	Listings	ETL / cETL, CE, RoHS, UKCA			

Not Included Items

Mounting Brackets	Mounting Brackets 50 100 200 300 mm Custom length	
Shields	Shield For Eminere Side 1 2 3 4	
Barndoors	Barndoor (with or without Side Covers) for Eminere Side 1 2 3 4	
	Optical Demo Set for Eminere Side	
ACCESSORIES	Field Installable Connector FF	Field Installable Connector FM
	Cable CE WCA	Cable US WCA
Cables and Connectors	Waterproof Cover Cap FM ZAHB-0006	
	CE/UL Leader Cables FF for Eminere 2 5 10 25 50m	
	CE/UL Jumper Cables FF/FM for Eminere 0.25 0.5 1 2 3 5 10m	
	Junction Box for Calumma S / Eminere	
Booster Box	Booster Box	

DIMENSIONS

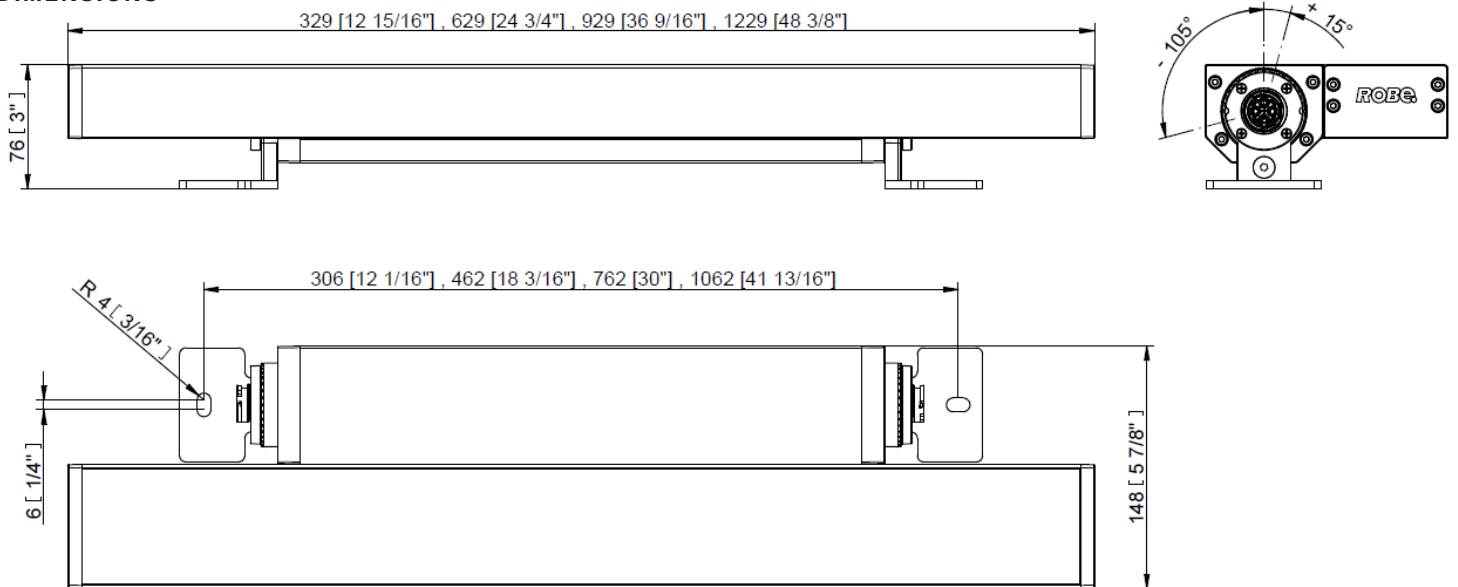

PHOTOMETRIC OVERVIEW

Based on RGBW version, all leds @ full

Lumen Output (lm)

	EMINERE SIDE 1	EMINERE SIDE 2	EMINERE SIDE 3	EMINERE SIDE 4
9°	1147	2 294	3 441	4 588
15°	978	1 956	2 910	3 912
30°	1 046	2 092	3 138	4 184
50°	1 039	2 078	3 117	4 156
65°	1 040	2 080	3 120	4 160
100°	996	1 992	2 988	3 984
10° x 30°	1 032	2 064	3 096	4 128
10° x 60°	1 051	1 874	2 811	3 748
15° x 90°	970	1 940	2 934	3 880
35° x 70°	1 040	2 080	3 120	4 160
15° x 45°	1 060	2 120	3 180	4 240
WallWasher	952	1 904	2 856	3 806
Wide WallWasher	854	1 708	2 562	3 416

PROJECTED AREA

	Front (rear) - m ²	Front (rear) ft ²	Side - m ²	Side - ft ²	Top - m ²	Top - ft ²
Eminere Side 1 with Shield	0,024 0,041	0,258 0,441	0,007 -	0,075 -	0,050 0,051	0,538 0,549
Eminere Side 2 with Shield	0,041 0,074	0,441 0,796	0,007 -	0,075 -	0,084 0,085	0,904 0,914
Eminere Side 3 with Shield	0,063 0,111	0,678 1,194	0,007 -	0,075 -	0,129 0,131	1,388 1,409
Eminere Side 4 with Shield	0,115 0,150	0,925 1,614	0,007 -	0,075 -	0,173 0,175	1,861 1,883

BI-SYMMETRICAL BEAM ANGLES

Bi-symmetrical: 10°x30°, 10°x60°, 35°x70°, 15°x90°

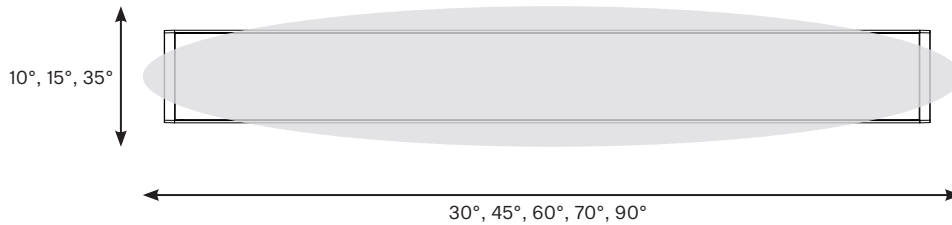

EMINERE SIDE INPUT OPTIONS

STANDARD

UPON REQUEST

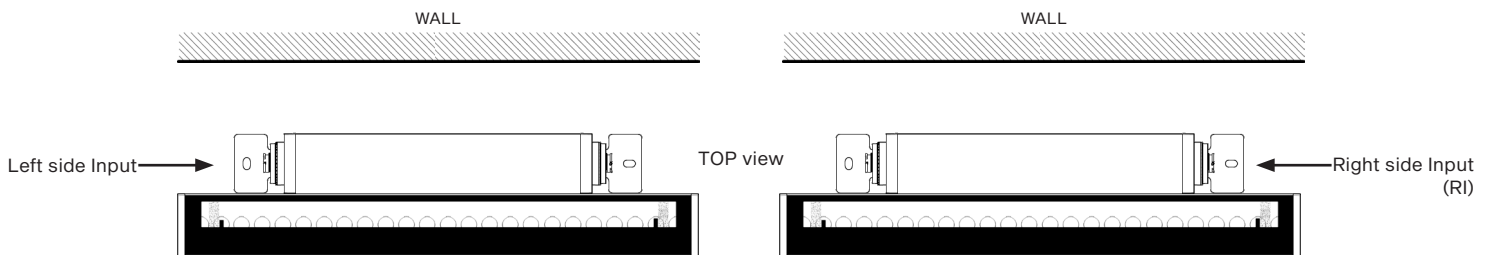

Note: Applies for all optic versions.

COLOUR MIXING PRINTS

STAND ALONE Specially designed glass printing to achieve optimal colour mixing and intensity distribution.

HEAD2HEAD Fixtures without special end glass print installed right next to each other create absolutely perfect colour and intensity overlap.

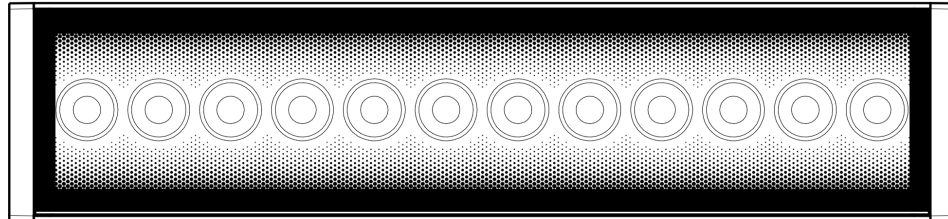

HEAD2HEAD

SYMMETRICAL

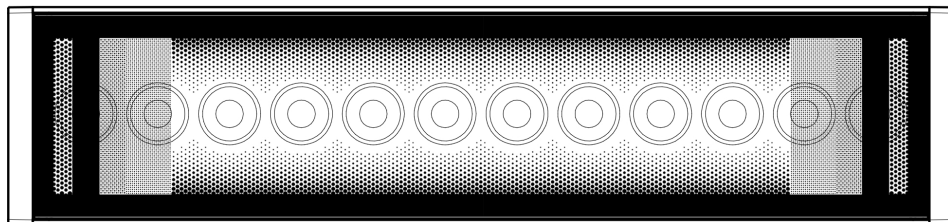

STAND ALONE

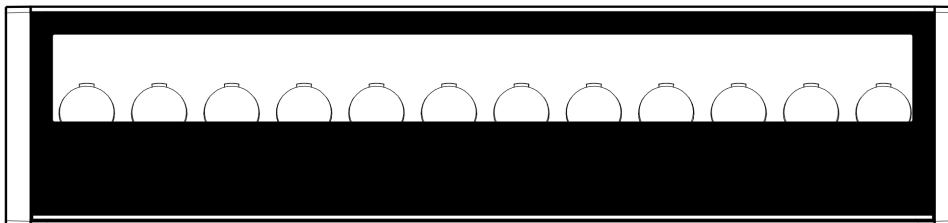

HEAD2HEAD

WALLWASHER

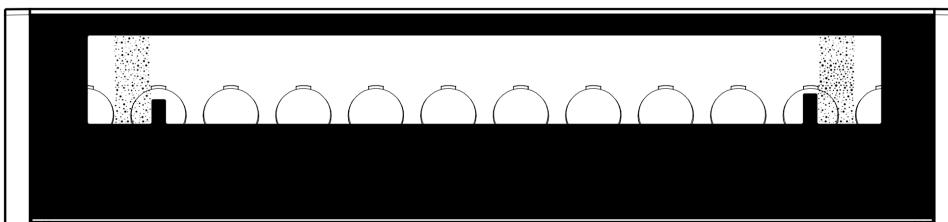

STAND ALONE

Note: Applies for RGBW, RGBA versions. Pure white and Tunable white versions are always without the end print (no matter on their position to other fixture).

E-BOX SPECIFICATION

ELECTRICAL	Input Voltage	120 – 277 V AC 50/60 Hz		
	Wireless DMX (Option)	Lumen Radio CRMX Technology		
	Interface Protocol	E-box Lite: USITT DMX512, RDM		
		E-box Daisy / Star: USITT DMX512, RDM, ArtNet, MA Net, MA Net2, sACN, Kling-Net		
Operating Modes	E-box Lite / Daisy: Fixture Mode, Pixel Mode, Output Mode			
	E-Box Star: Total Mode, Fixture Mode, Pixel Mode, Output Mode			
CONTROL	Display	Via Two Row LCD Display with Control Buttons or RDM communicator		
	Control System	E-box With Self Addressing Feature or Custom Setting Via LCD Display/RDM		
	Power Supply	Integrated		
	Connectivity	E-box Lite	127 of Eminere Side 1 (@ 230 V and 30m cable) via 1 Output	
		E-box Daisy	127 of Eminere Side 1 (@ 230 V and 30m cable) via 1 Output	
		E-box Star	127 of Eminere Side 1 (@ 230 V and 30m cable) via 6 Outputs	
	Length x Width x Height	E-box Lite	220 x 120 x 81 mm (8.66 x 4.72 x 3.18 in.)	
		E-box Daisy	260 x 160 x 91 mm (10.24 x 6.30 x 3.58 in.)	
		E-box Star	280 x 230 x 111 mm (11.02 x 9.06 x 4.37 in.)	
	Weight	1.67 kg 3.85 lbs	2.78 kg 6.13 lbs	4.4 kg 9.7 lbs
Housing	Die-Cast Aluminium Case			
Finish Options	Standard Colour - Graphite Black (RAL 9011) Silver (RAL 9006)			
	Cost Option - Custom RAL Harsh Environment (RAL 9016, RAL 9011)			
Cables / Connections	Cable Grommet (stainless steel)			
Mounting Method	Surface Mount , 4 Mounting Holes			
Protection Factor	IP67 / Suitable For Wet Locations			
IK Rating	IK10			
Cooling System	Convection			
Operating Ambient Temperature	-20 °C / +40 °C (-4 °F / +104 °F)			
CERTIFICATION	Listings	ETL / cETL, CE, RoHS, UKCA		

COMPARISON

	E-BOX LITE	E-BOX DAISY	E-BOX STAR
Power input	1	1	1
Fixture Output	1	1	6
Total load (current)	16A	16A	16A
DMX control	YES	YES	YES
RDM	YES	YES	YES
Art-Net	NO	YES	YES
Ethernet switch	NO	YES	YES
Kling-Net	NO	YES	YES
sACN	NO	YES	YES
MA Net, MA Net2	NO	YES	YES

E-BOX DIMENSIONS

E-BOX LITE

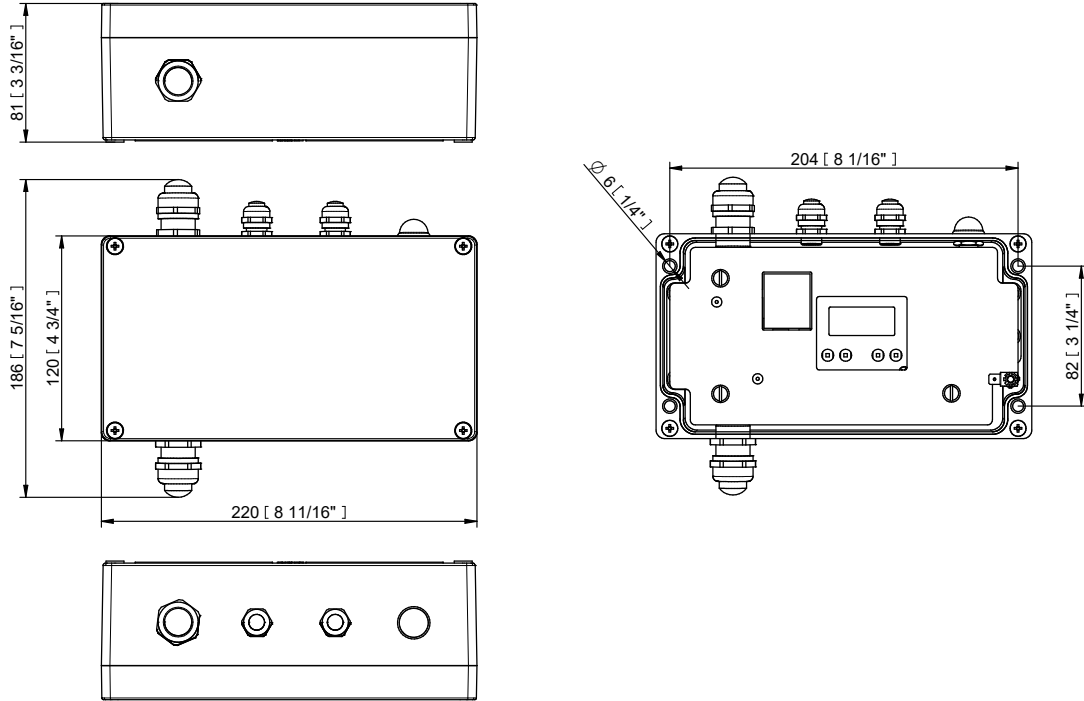

E-BOX DAISY

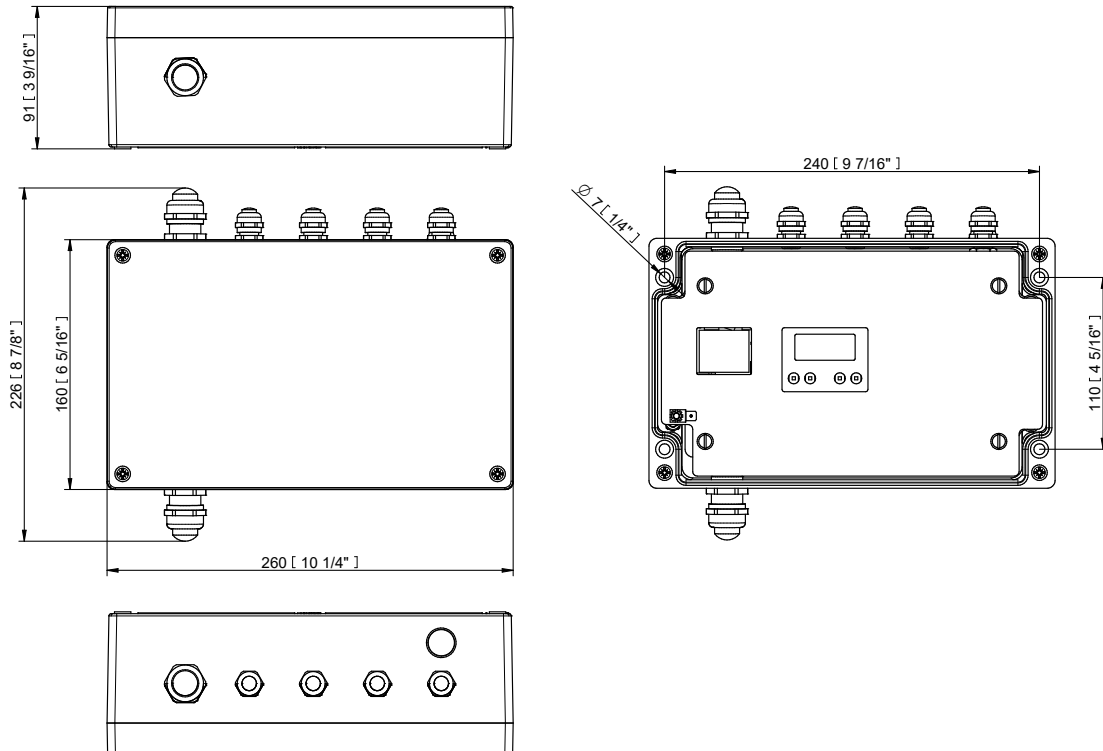

E-BOX STAR

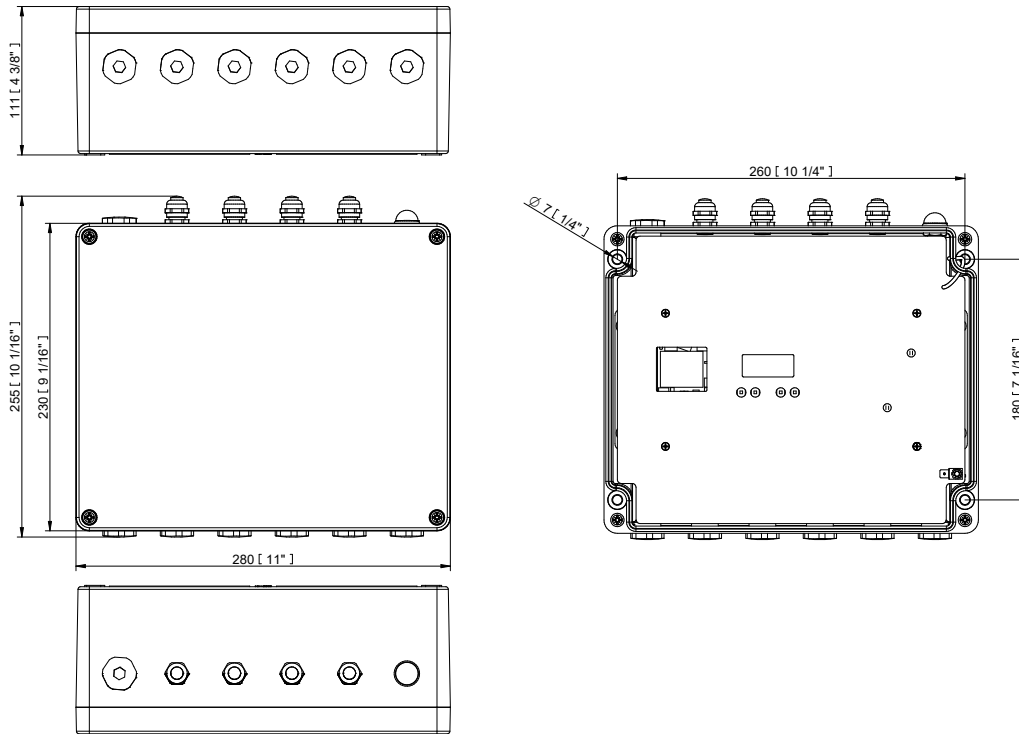

CONNECTIVITY

The tables below state max. theoretical number of Emineres connected to the one LED output of the E-box without using Booster boxes.

	Cable length (m)	Voltage (V)			
		120	190	230	277
EMINERE 1	10	66	104	127	152
	20	66	104	127	152
	30	46	104	127	152
	50	28	70	102	148
	70	20	50	73	106
	100	13	35	51	74
	200	7	17	25	37
EMINERE 2	10	36	56	69	83
	20	36	56	69	83
	30	24	56	69	83
	50	15	38	56	80
	70	10	27	40	57
	100	9	18	28	40
	200	3	9	16	20

	Cable length (m)	Voltage (V)			
		120	190	230	277
EMINERE 3	10	25	40	48	59
	20	25	40	48	59
	30	17	40	48	59
	50	11	26	39	57
	70	7	19	28	40
	100	5	13	19	28
	200	2	6	10	14
EMINERE 4	10	19	31	37	45
	20	19	31	37	45
	30	14	31	37	45
	50	8	20	30	44
	70	5	15	21	35
	100	3	10	15	21
	200	1	4	7	11

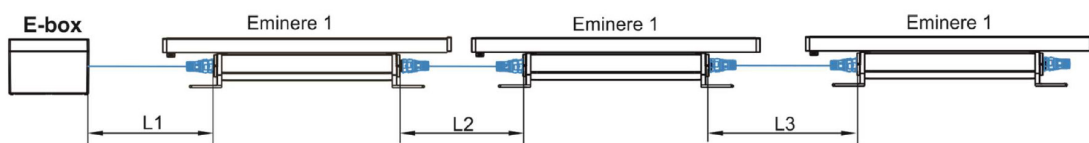

Note: Cable length is a total cable length between E-box and last connected Eminere. Example: Total cable length=L1+L2+L3.
For more information see User Manual.

CONNECTION
E-BOX LITE / DAISY

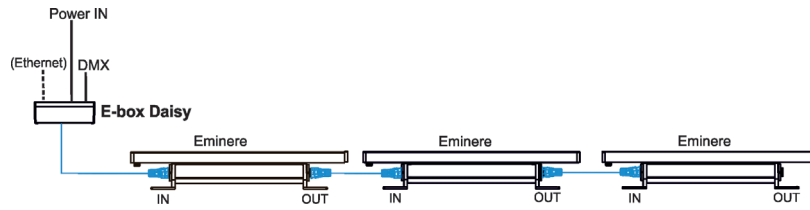

E-BOX STAR

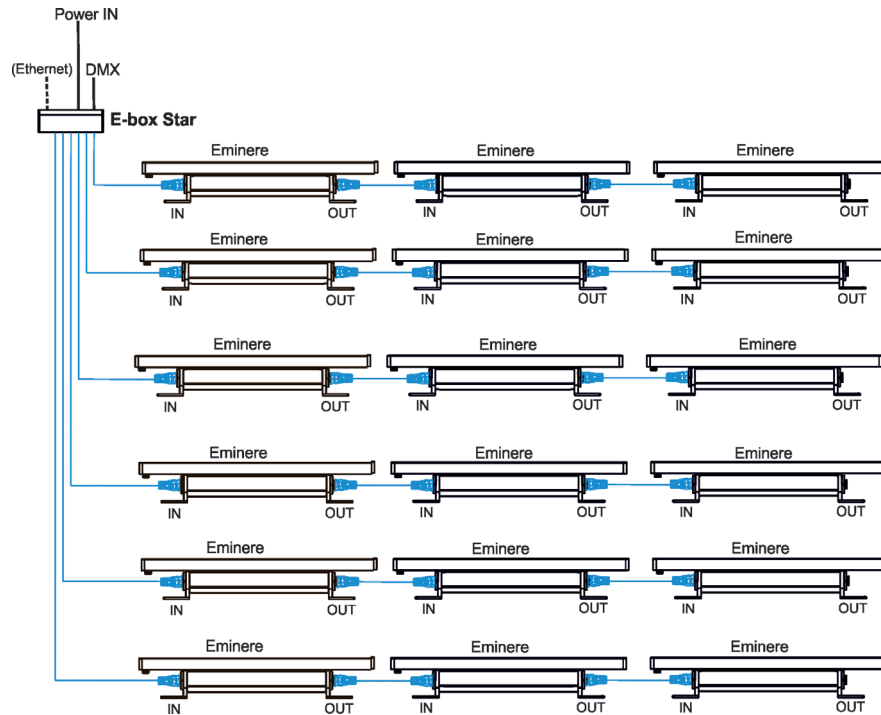

CONNECTION - WIRELESS VERSION

Connection setup, where every Eminere is independently accepting data from WIFI.

A



B

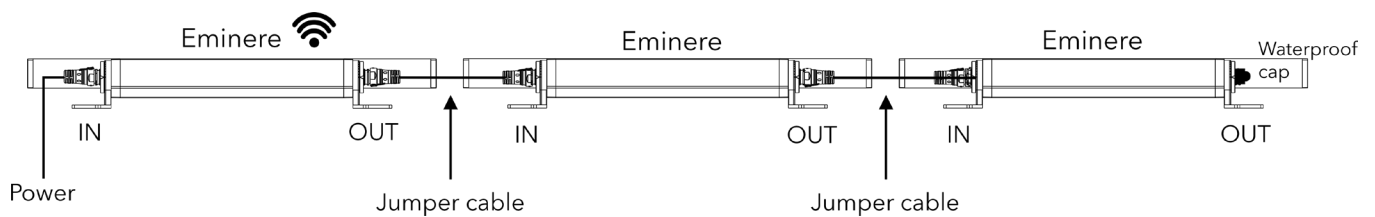

CONNECTION - ON / OFF VERSION

A 1) Junction Box or by Others

2) CE/UL Leader Cables FF for Eminere
2 | 5 | 10 | 25 | 50 m

3) CE/UL Jumper Cables FF/FM for Eminere
0.25 | 0.5 | 1 | 2 | 3 | 5 | 10 m

4) Booster Box

5) Waterproof Cap

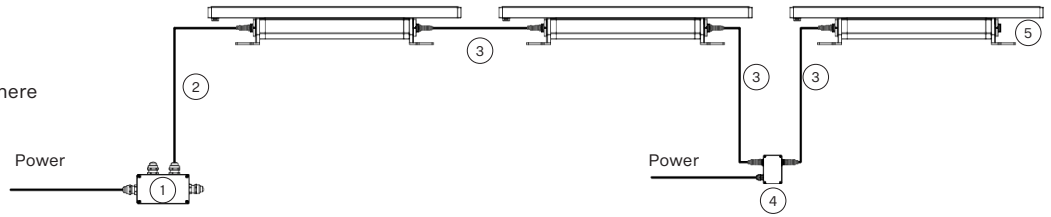

B 1) Power Cable (by Others)

2) Field Installable Connector FF (13053003)

3) Field Installable Connector FM (13053004)

4) Waterproof Cap

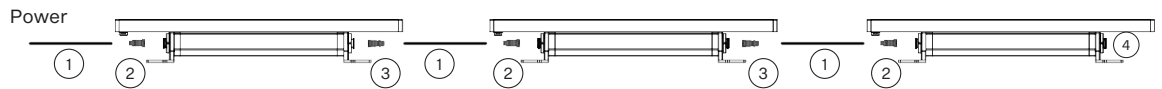

CONNECTION - DALI VERSION (CE)

1) Hybrid Cable (13053693) Standard with bare-end

2) Field Installable Connector FF DC-05 (13053971)

3) Eminere DALI with Panel Connector MM (13053975) &
Panel Connector MF (13053974)

4) Field Installable Connector FM DC-05 (13053973)

5) Junction Box

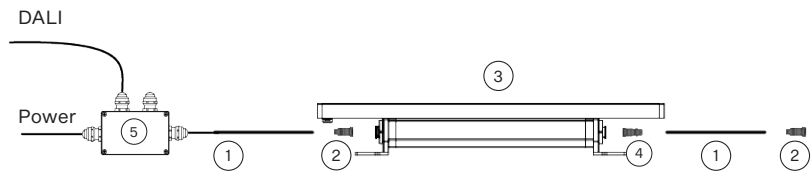

Note: The last unplugged connector must be fitted with a Waterproof Cap to protect the IP rating.

CONNECTION - DALI VERSION (US)

1) SJTW 5x14 AWG (13053693), Standard 1 m with bare-end, black
or on request Cable SJTW 5x14 AWG (13053697), with bare-end, white

2) Field Installable Connector FF DC-05 (13053971)

3) Eminere DALI with Panel Connector MM (13053975)
& Panel Connector MF (13053974)

4) Field Installable Connector FM DC-05 (13053973)

5) Junction Box

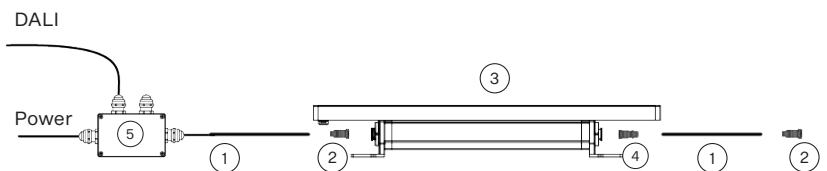

Note: The last unplugged connector must be fitted with a Waterproof Cap to protect the IP rating.

DMX WITH JUNCTION BOX FOR CALUMMA S / EMINERE (CE)

- 1) Leader Cables FF for Eminere - 2 | 5 | 10 | 25 | 50 m
- 2) Jumper Cables FF/FM for Eminere - 0.25 | 0.5 | 1 | 2 | 3 | 5 | 10 m
- 3) Junction Box for Calumma S / Eminere (10981268 for RAL9011)
- 4) Flamar 3x16 AWG + 1x(2x24 AWG) Standard 1 m with bare-end, (13051508), black or Hybrid Cable HYB-5731ZH LSZH (13053694), white
- 5) Junction Box

Note: The last unplugged connector must be fitted with a Waterproof Cap to protect the IP rating.

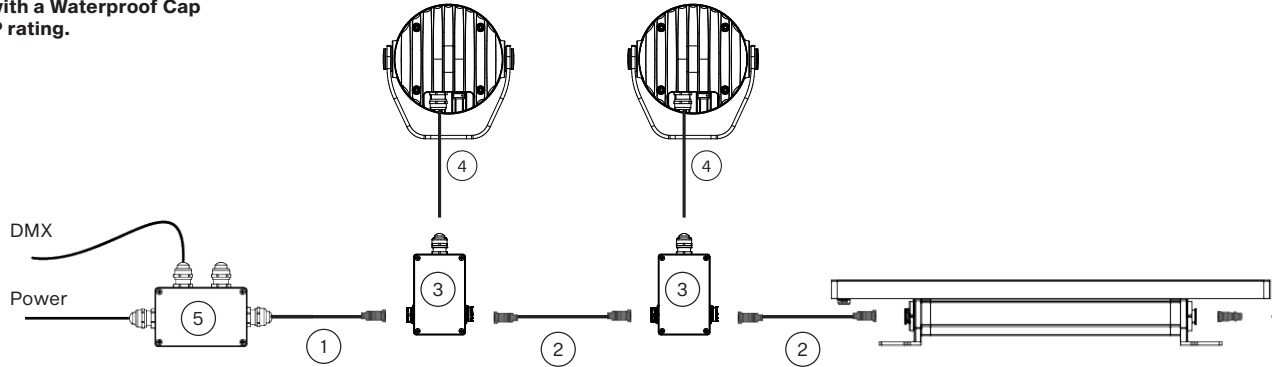

DMX WITH JUNCTION BOX FOR CALUMMA S / EMINERE (US)

- 1) Leader Cables FF for Eminere - 2 | 5 | 10 | 25 | 50 m
- 2) Jumper Cables FF/FM for Eminere - 0.25 | 0.5 | 1 | 2 | 3 | 5 | 10 m
- 3) Junction Box for Calumma S / Eminere (10981269 for RAL9011)
- 4) SJTW 6x14 AWG (13053480) Standard 1 m with bare-end, black or Cable SJTW 6x14 AWG (13053695), white

Note: The last unplugged connector must be fitted with a Waterproof Cap to protect the IP rating.

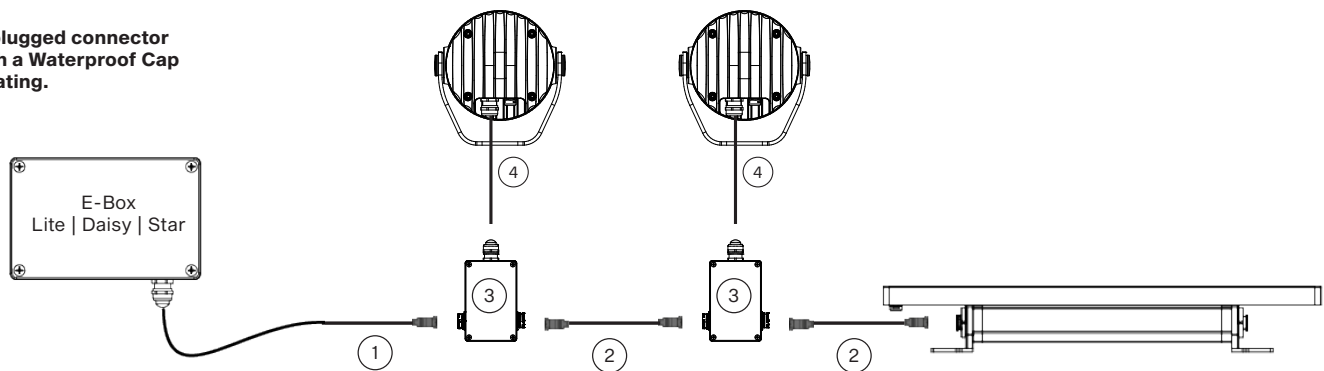

THE BOOSTER BOX

To compensate a voltage drop in a large installation, the Booster boxes have to be connected in the chain of Eminere modules.

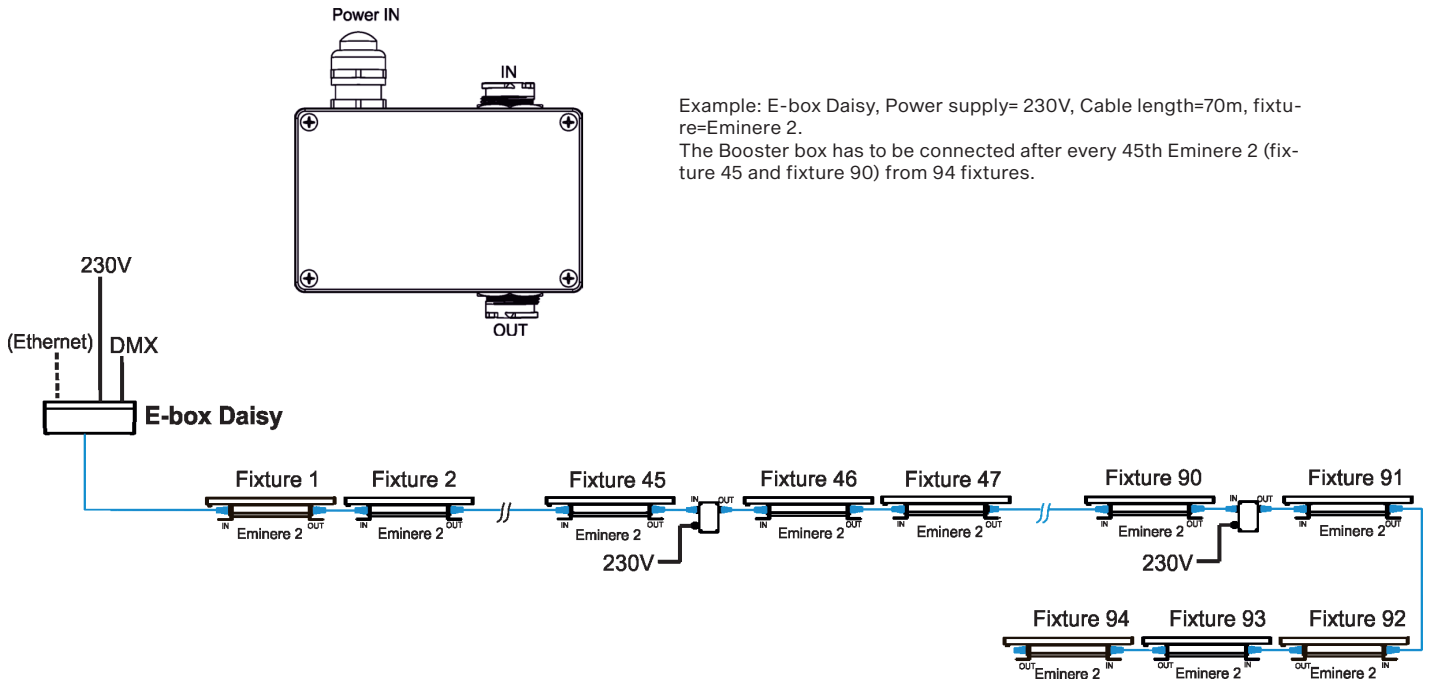

BOOSTER BOX DIMENSIONS

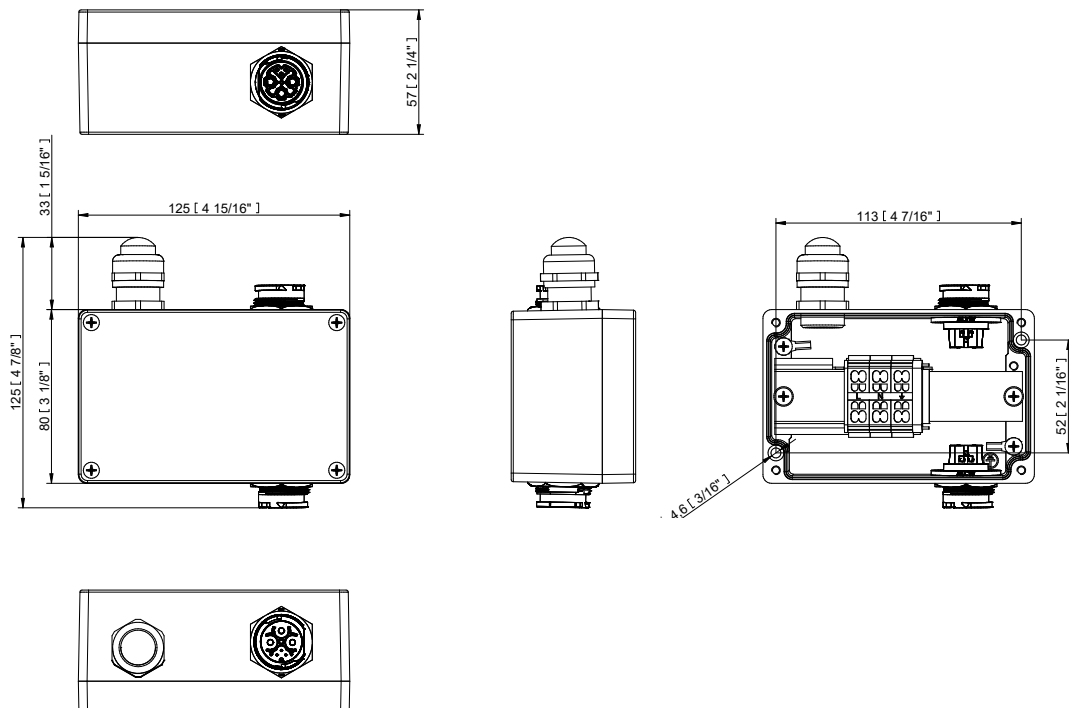

BOOSTER BOX POSITIONS

	Cable length (m)	Max. number of Emineres 1 = 191 (in Standard mode)			
		120 V	190 V	230 V	277 V
EMINERE 1	10 m	66,132	104	127	-
	20 m	66,132	104	127	-
	30 m	46,92,138	104	127	-
	50 m	28,56,84,112,140	70,140	102	148
	70 m	20,40,60,80,100,120,140	50,100,150	73,146	106
	100 m	13,26,39,52,65,78,91,104,117,130,143	35,70,105,140	51,102	74,148
	200 m	7,14,21,28,35,42,49,56,63,70,77,84,91,98,105,112, 119,126,133,140,147	17,34,51,68,85,102,119,136	25,50,75,100,125,150	37,74,111,148

Note: For more detail see the User manual.

ACCESSORIES

Shield for Eminere side

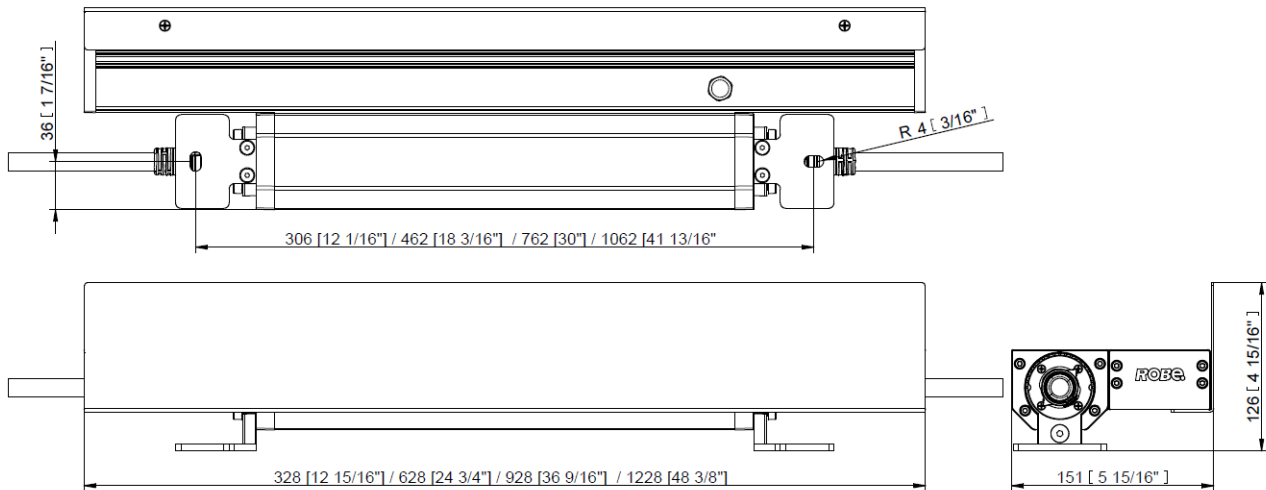

Mounting Brackets for Eminere Side

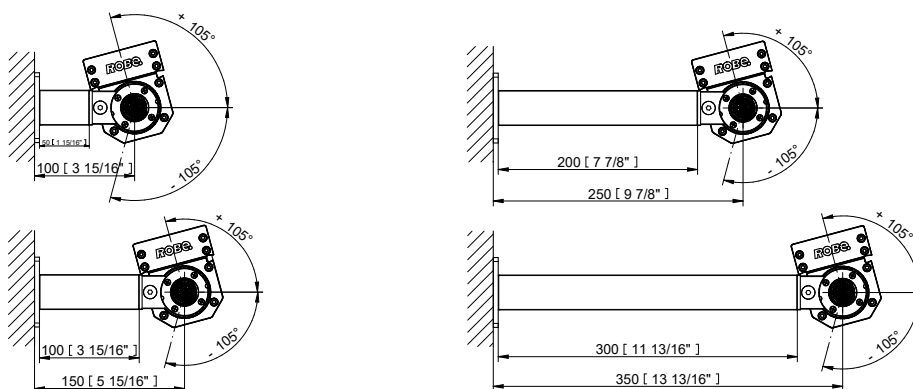

Barndoor without side cover

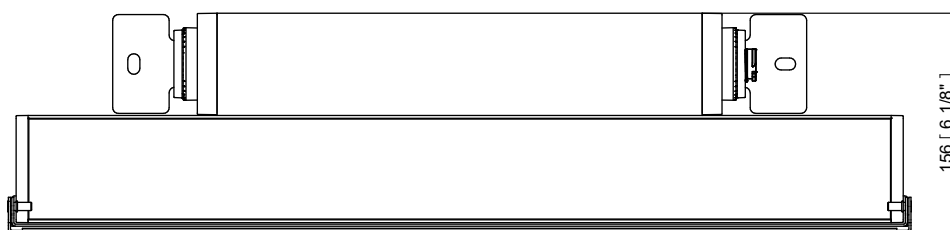
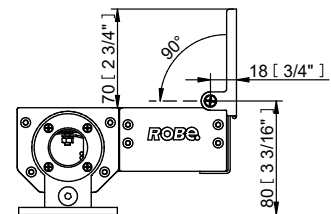
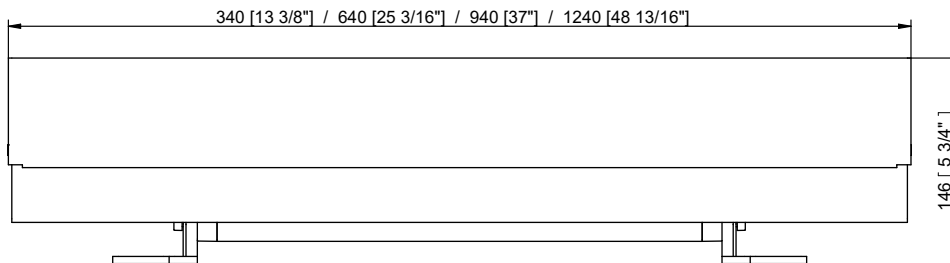

Barndoor without side cover

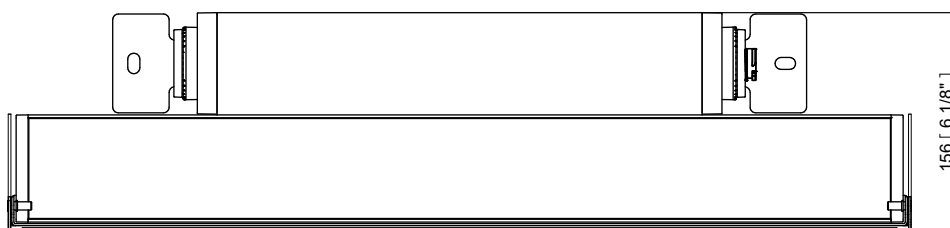
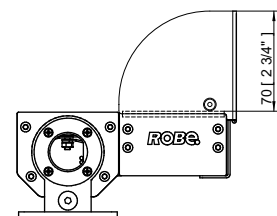
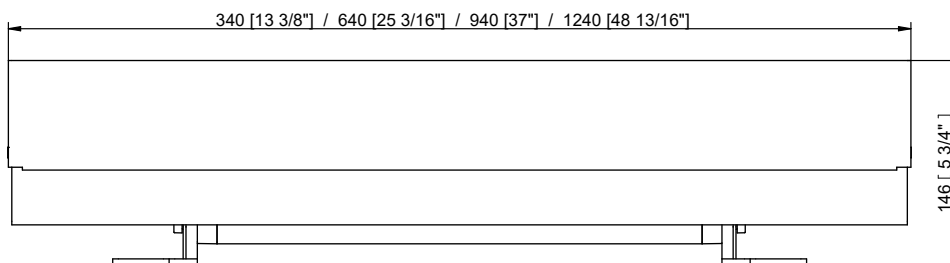

CABLES

Leader Cable

For connecting E-Box with first Eminere. Comes with Waterproof End Cap which has to be installed to the last Eminere's output connector.

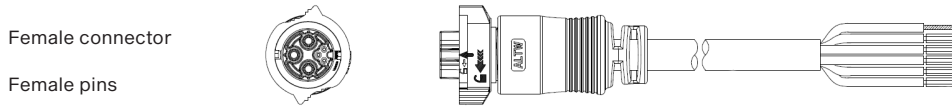

Female connector

Female pins

Jumper Cable

For connection between two Emineres.

NOTE: Custom length of Jumper cable depends on the distance between two Eminere luminaires (length includes cable and connectors).

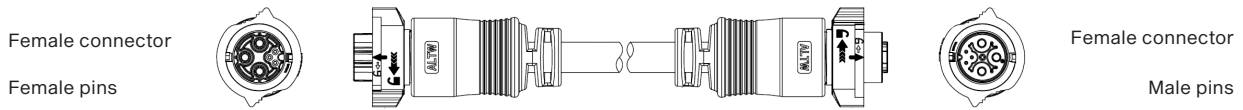

Female connector

Female pins

Female connector

Male pins

Field installable connector

For special cases, where Jumper Cable can't be used. Then use Leader Cable with Field installable connector to make a connection between Emineres.

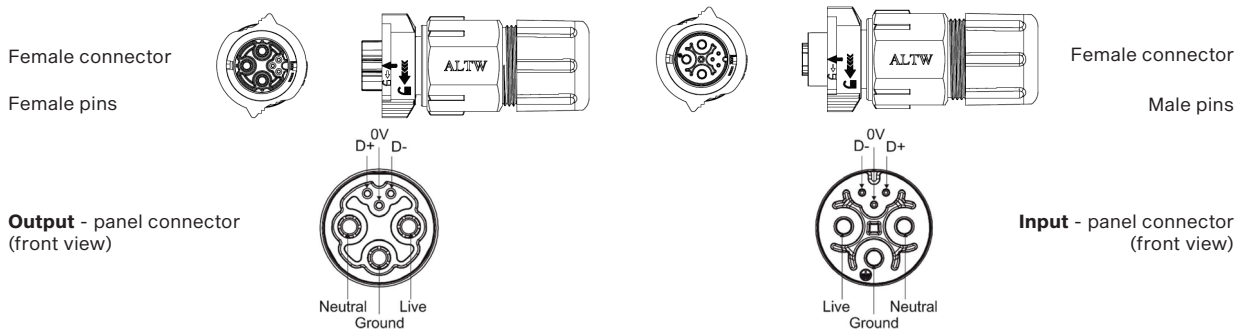

Female connector

Female pins

Female connector

Male pins

Output - panel connector
(front view)

Input - panel connector
(front view)

Waterproof End Cap

Install at the end of line to the last Emineres output connector.

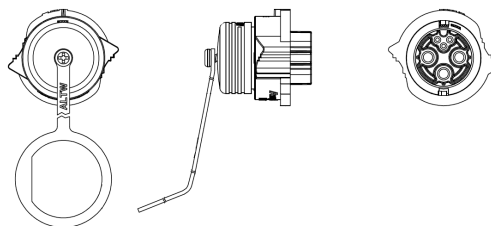

Cable lengths available

IN METRES	LEADER CABLE	JUMPER CABLE
0.25	-	YES
0.5	-	YES
1	-	YES
2	YES	YES
3	-	YES

IN METRES	LEADER CABLE	JUMPER CABLE
5	YES	YES
10	YES	YES
25	YES	-
50	YES	-
Other lengths	On Request	

PHOTOMETRIC DATA

Eminere Side 4 RGBCW 9dg

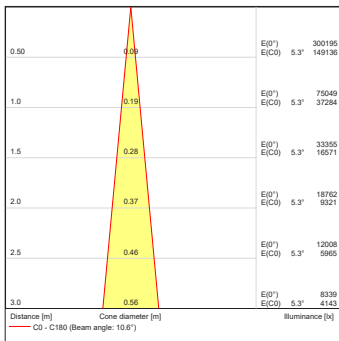
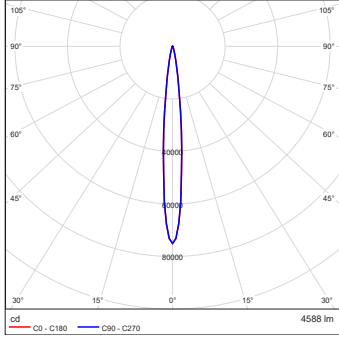

Eminere Side 4 RGBCW 15dg

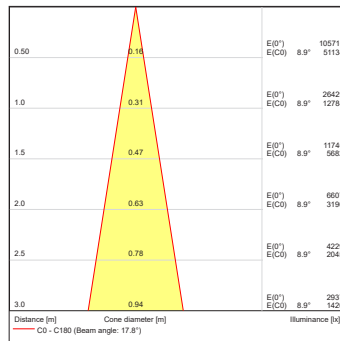
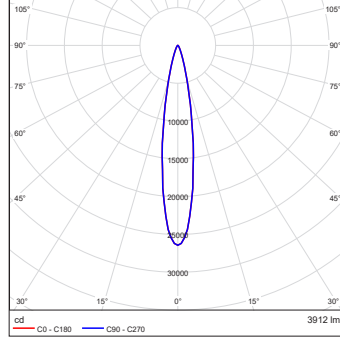

Eminere Side 4 RGBCW 30dg

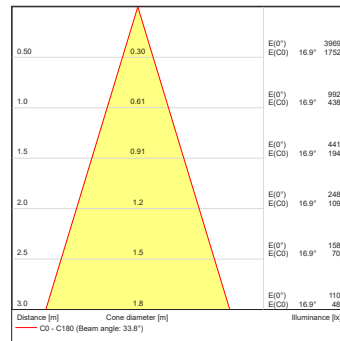
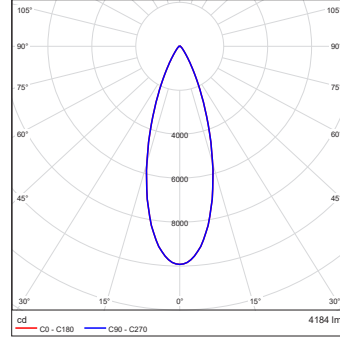

Eminere Side 4 RGBCW 50dg

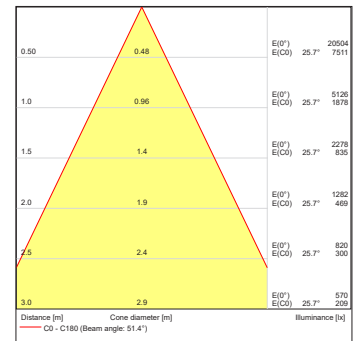
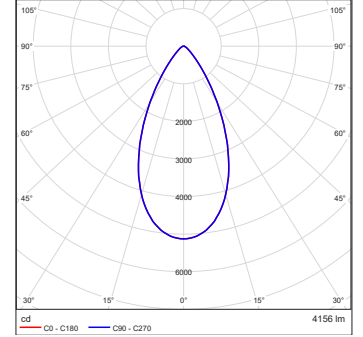

Eminere Side 4 RGBCW 65dg

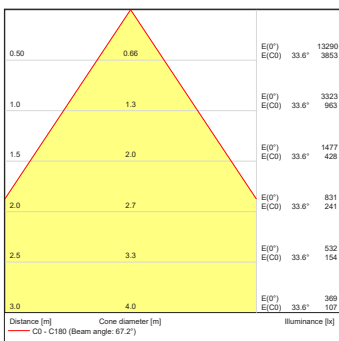
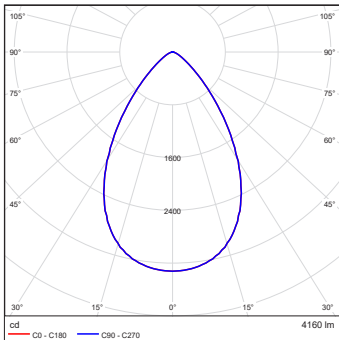

Eminere Side 4 RGBCW 100dg

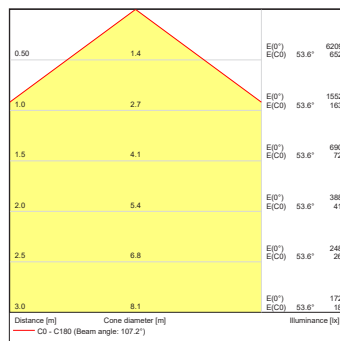
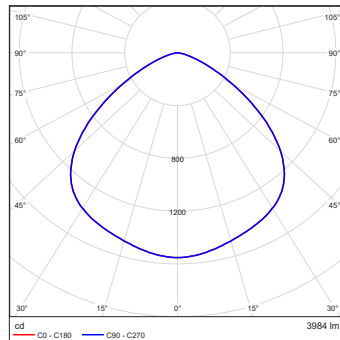

PHOTOMETRIC DATA

Eminere Side 4 RGBCW 10dg x 30 dg

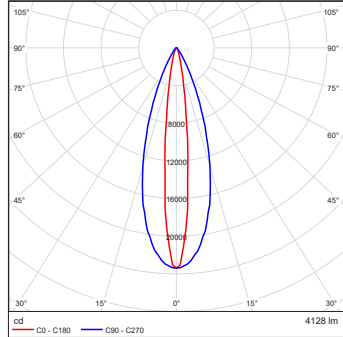

Eminere Side 4 RGBCW 10dg x 60 dg

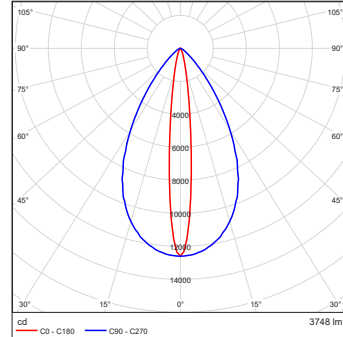

Eminere Side 4 RGBCW 35dg x 70dg

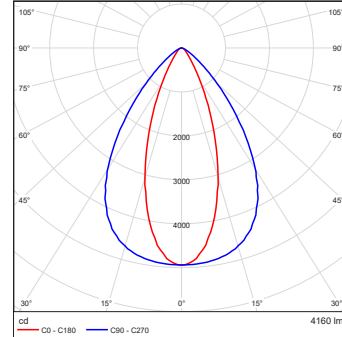

Eminere Side 4 RGBCW 15dg x 90dg

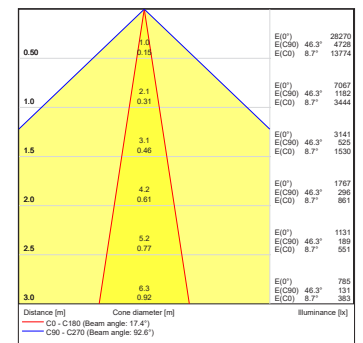
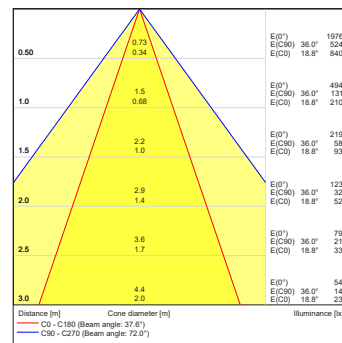
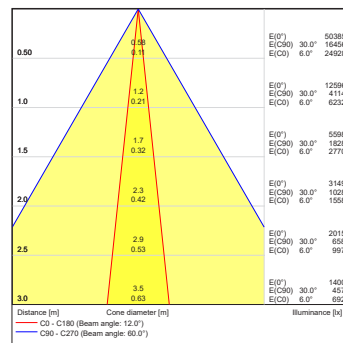
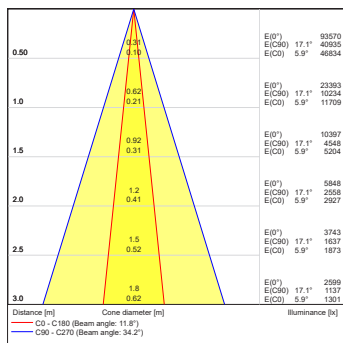
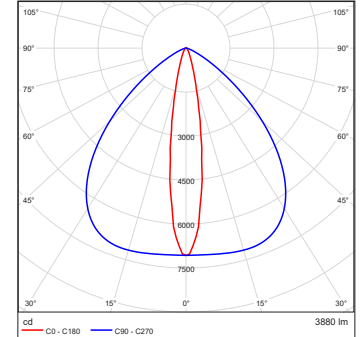

Eminere Side 4 RGBCW 15dg x 45dg

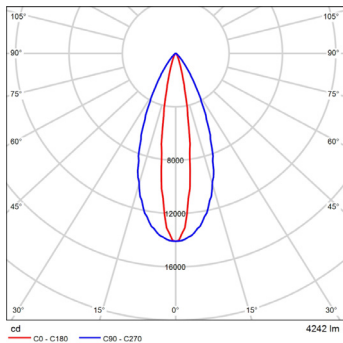

Eminere Side 4 RGBCW WallWasher

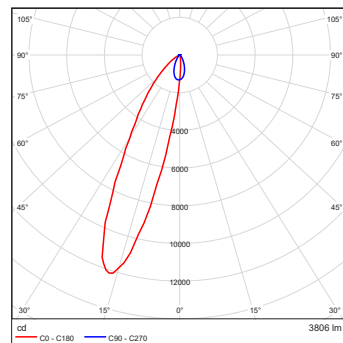

Eminere Side 4 RGBCW Wide WallWasher

