

LYRAE™ M SC

Difficult inground installations are made easier with the Lyrae M SC. High light output comes from powerful LEDs and it can be used with a variety of optics, from narrow to wide, in addition to a bi-symmetrical option. The light source can be remotely tilted 25° from the horizontal position, always ensuring accurate illumination of the selected surface. Additionally, Lyrae M SC can be equipped with anti-skid glass featuring the highest standards of certification for anti-slip usage having no impact on the fixture's outstanding colour mixing.



KEY FEATURES

Lumen output & Light source

Luminaire with high-power LEDs provides outstanding output. Multiple CCT options. No light spills. Perfectly homogenised light output with high efficacy.

Design & Durability

Compact, durable and stylish housing made of high-pressure die cast aluminium. IP68 and IK10 certification; suitable for marine and traffic applications. Supported with a 5 year warranty.

Flexibility

Exceptional inground LED luminaire with a multiple light output variants and beam angles.

COLOURS

* UPON REQUEST

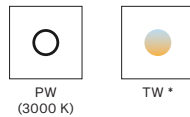

CONTROL & PROTOCOLS



STANDARD & SPECIFICATION

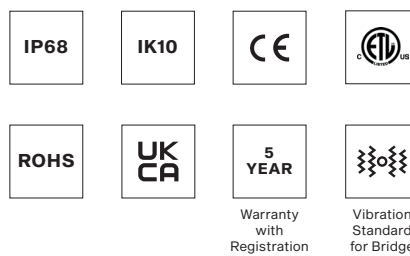

TRIM FINISH OPTIONS



COLOUR TEMPERATURE

* UPON REQUEST

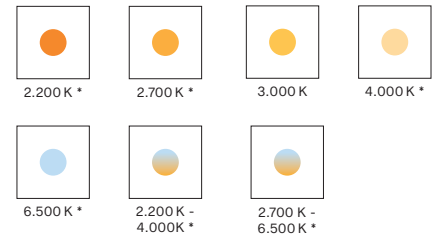

OPTIC OPTIONS

SYMMETRICAL

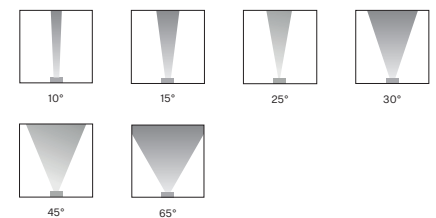

BI-SYMMETRICAL

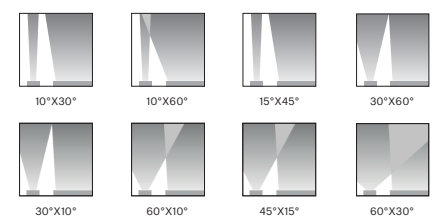

TRIM OPTIONS

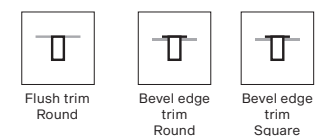

SPECIFICATION

ELECTRICAL	Input Voltage	120 - 277 V AC 50/60 Hz	
	Typical Power Consumption	60 W +/-10 %	
OPTICAL	Light Source	High Power Single Chip LEDs	
	Colour Variants	PW (3000 K) Variants On Request (TW (2200 - 4000 K 2700 - 6500 K) 2200 K 2700 K 4000 K 6500 K)	
	Beam Angle	Clear Glass	Symmetrical: 10° 15° 25° 30° 45° 65° Bi-symmetrical: 10°x30° 30°x10° 10°x60° 60°x10° 15°x45° 45°x15° 30°x60° 60°x30°
		Anti-Skid Glass	Symmetrical: 18° 22° 35° 50° 65° (preliminary) Bi-symmetrical: 20° x 35° 35° x 20° 20° x 65° 65° x 20° 20° x 50° 20° x 50° 35° x 65° 65° x 35° (preliminary)
	Lumen Output Delivered	2676 lm (@10° PW 3000 K)	
	Projected Lumen Maintenance	L90B10 >90.000 hrs, Ta = 25°C / 77°F	
CONTROL	Interface Protocol	DMX/RDM DTP DALI 2 NFC	
	Operating Modes	DMX, Stand-alone	
	Settings / Addressing	RDM NFC (Stand-alone)	
	Power Supply	Integrated	
PHYSICAL	Flange Diameter x Diameter x Height	Bevel Edge Trim: ø 270 x ø 337 x 300 mm (ø 10.7 x ø 13.3 x 11.8 in.)	
	Weight	6.75 kg 14.9 lbs	
	Housing	High Pressure Die-Cast Aluminium Body Stainless Flange Tempered Glass (Clear or Anti-Skid)	
	Trim Options	Bevel Edge Trim Flush Trim	
	Trim Finish Options	Stainless steel	
	Trim Shape	Round Square	
	Cables / Connections	Integrated Junction Box	
	Mounting Method	External Mounting Sleeve	
	Adjustability	Motorised Tilt 0° - 25° (One Direction Tilt) - Setting-up via NFC (password protected), or DMX	
	Protection Factor	IP68 / Suitable For Wet Locations	
	IK Rating	IK10	
	Static Load Resistance	35 kN (TBC)	
	Cooling System	Convection	
	Operating Ambient Temperature	-20 °C / +40 °C (-4 °F / +104 °F)	
CERTIFICATION	Listings	ETL / cETL, CE, RoHS, UKCA	
ACCESSORIES	Not Included Items		
		Lyrae M Mounting Sleeve	
		Junction Box (CE or US)	
		Trim for Lyrae M (Stainless Steel, Round, Bevel Edge)	
		Trim for Lyrae M (Stainless Steel, Round, Flush)	
		Trim for Lyrae M (Stainless Steel, Square, Bevel Edge)	
		Re-enterable Electrical Insulating Resin	
	Rock Guard		
DEMO SET	Lyrae M Demo Set	Includes: Lyrae fixture, Mounting Sleeve, Trim, Set of Optical Foils (Not suitable for permanent instalations. IP2X.)	

DIMENSIONS

with Round beveled Trim

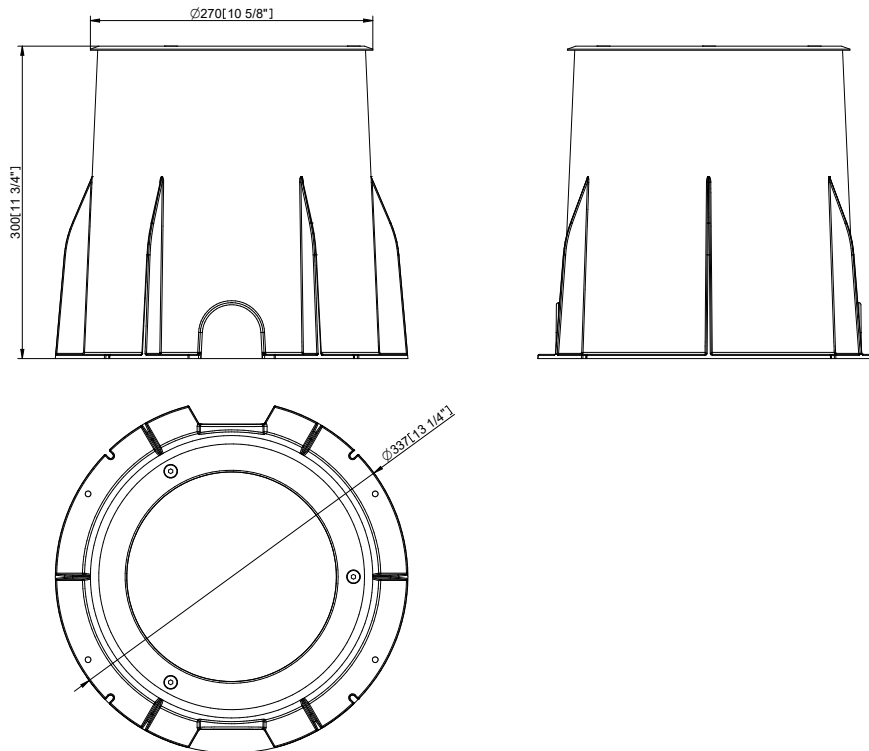

with Square beveled Trim

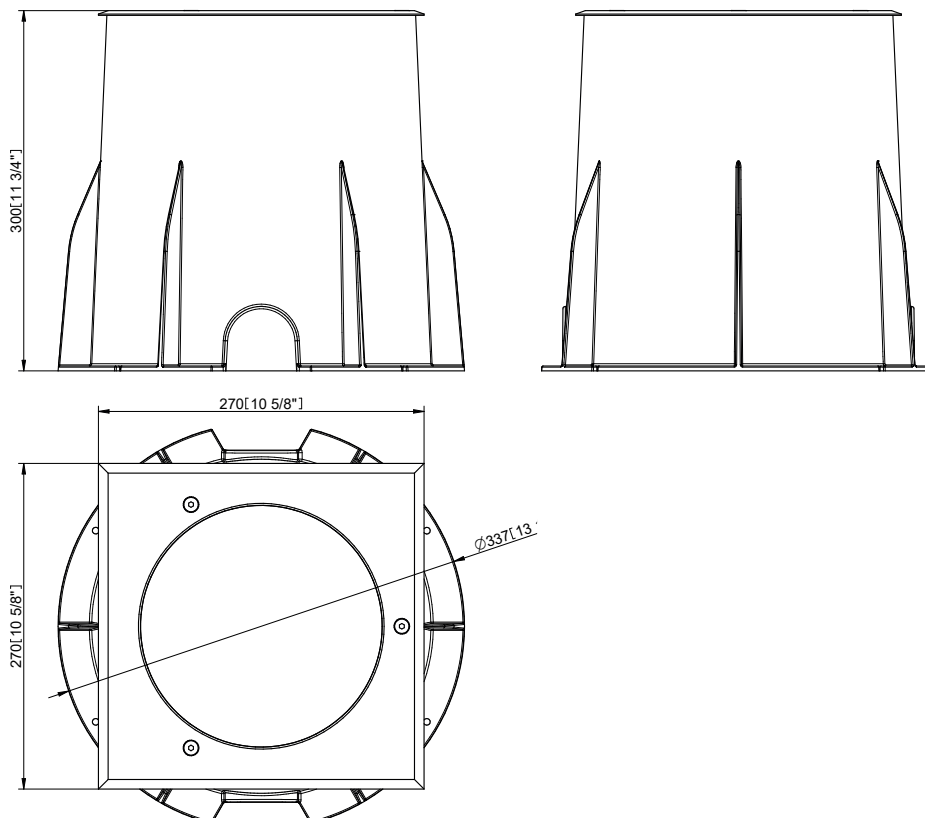

with Round Flush Trim

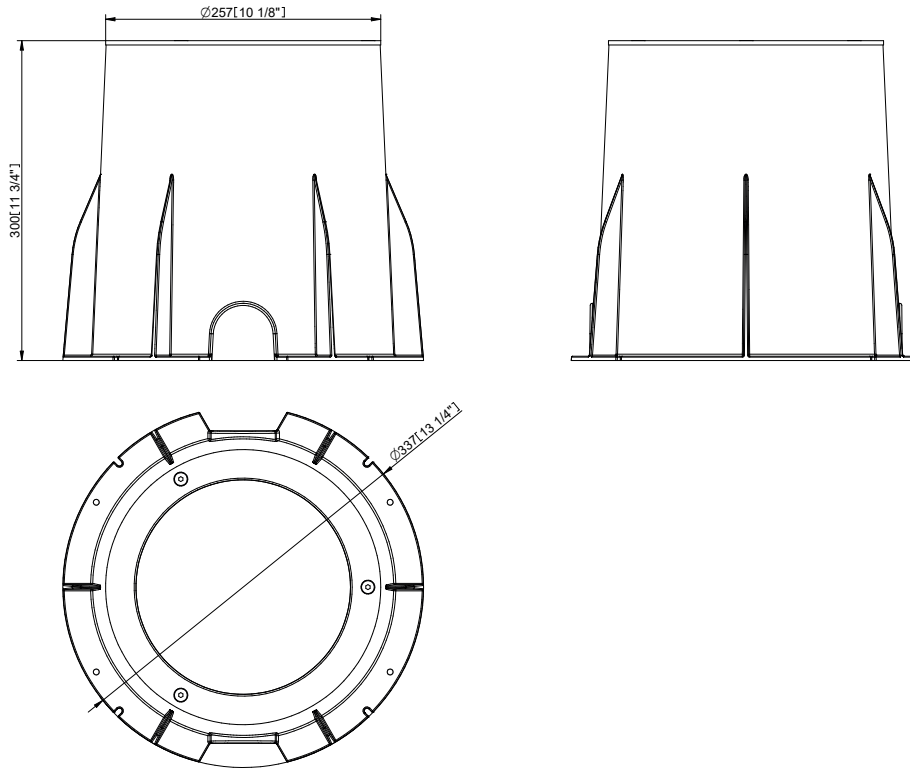

BI-SYMMETRICAL BEAM ANGLES

Bi-symmetrical:
10°x30°,
10°x60°,
15°x45°,
15°x90°,
30°x60°

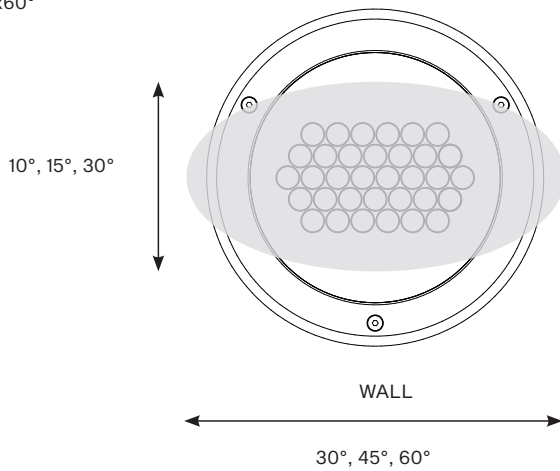

Bi-symmetrical:
10°x30°,
10°x60°,
15°x45°,
15°x90°,
30°x60°

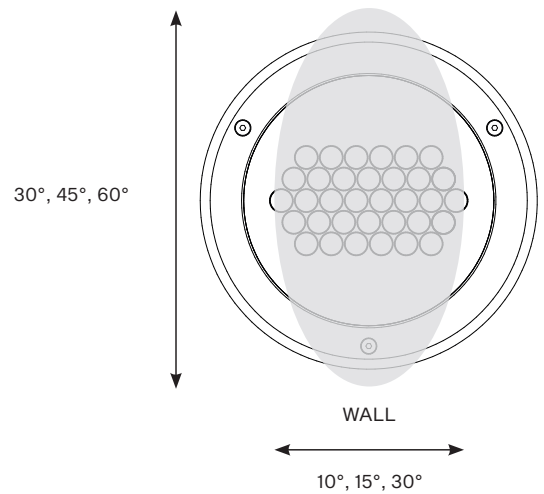

CONTROL AND CONNECTION OPTIONS - CE

DALI

Example of ordering code: Lyrae M SC RGCBCW 15° DALI

- 1) Junction Box
- 2) Hybrid Cable (1305 3693)
or
Scope of Others

Note: All Anolis cables must be in placed in protective conduit – not suitable for direct burial.

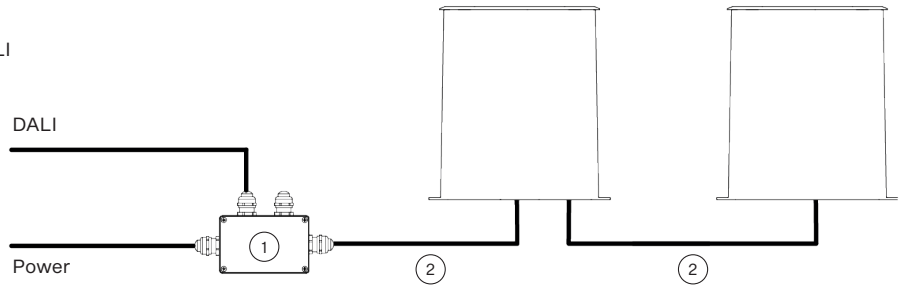

DMX

- 1) Junction Box
- 2) Cable (1305 1508)

Note: All Anolis cables must be in placed in protective conduit – not suitable for direct burial.

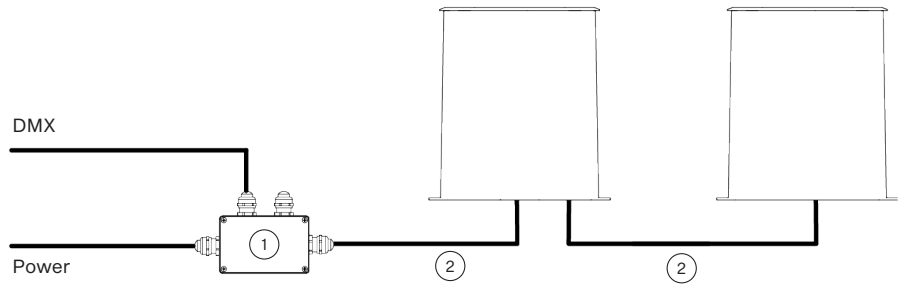

DMX or ETHERNET via E-BOX

- 1) Cable CE WCA (1305 3138)

Note: All Anolis cables must be in placed in protective conduit – not suitable for direct burial.

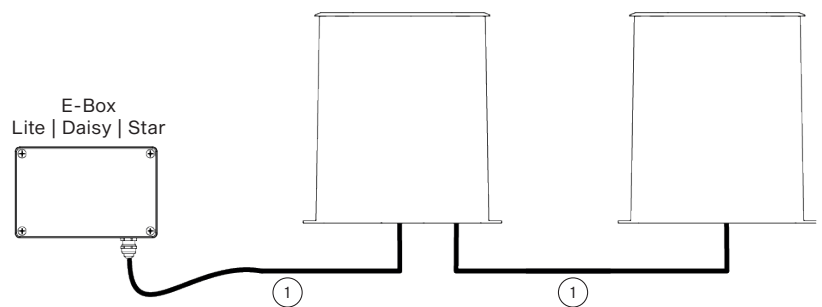

CONTROL AND CONNECTION OPTIONS - US

DALI

Example of ordering code: Lyrae M SC RGBCW 15° DALI

- 1) Junction Box
- 2) SJTW 5x 14AWG (13053336), black
or
Scope of Others

**Note: All Anolis cables must be in placed
in protective conduit – not suitable
for direct burial.**

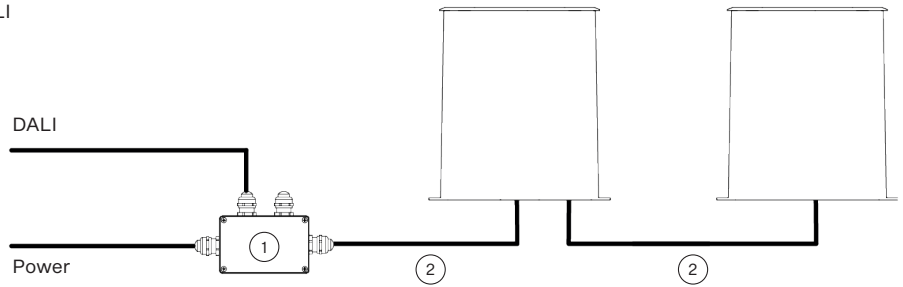

DMX or ETHERNET via E-BOX

- 1) Cable US WCA (1305 3139)

**Note: All Anolis cables must be in placed
in protective conduit – not suitable
for direct burial.**

