

EMINERE® 1 / 2 / 3 / 4

Eminere was designed by Anolis for a wide range of exterior and interior applications with a variety of lens options that can be used for flood lighting, wall grazing, wall washing and accent lighting. Equipped with Anolis' unique 18-bit colour mixing resolution ensures extra fine colour tuning as well as smooth dimming at low level of intensity. Designed in our state of the art R&D facility by industry experts, Eminere is IP67 rated and can withstand extreme conditions. Eminere is available in 1, 2, 3, and 4 foot sizes (300/600/900/1200 mm) with RGBW, RGBA or PureWhite single chips as standard and is easy to control, 1 pixel per foot. Eminere fixtures can be used for both permanent and temporary installations, including various architectural and archtainment applications.



KEY FEATURES

Application Flexibility

Eminere's optics can be used for various applications including wall grazing, flood lighting, wall washing, wide flood lighting, spot lighting and accent lighting.

Quick and Easy Installation

Plug & Play system means easy installation, fast adjustment and intuitive programming with self-addressing.

Naturally looking result

Full spectrum coverage by using RGBW colour mixing with precise wave lengths of each colour for modern architecture or specifically designed combination of RGBA to highlight every single detail of historical buildings or monuments. Output up to 1.147 lm (RGBW) or 1.652 lm (PW) per one foot of Eminere.

Durability

Eminere is rated IP67, suitable for wet locations and has a protection rating of IK06. Marine grade finish option available for harsh environmental conditions (on request).

COLOURS

* UPON REQUEST



COLOUR TEMPERATURE

* UPON REQUEST

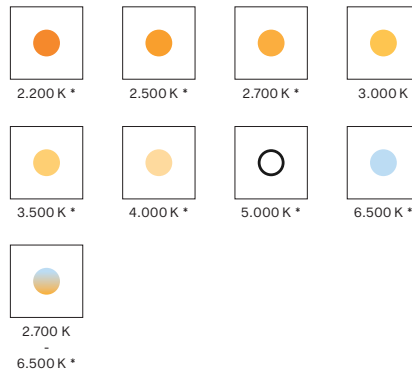

CONTROL & PROTOCOLS

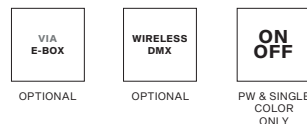

FINISH OPTIONS

* CLOSEST RAL TONE

All standard finish options are available in a harsh environment finish.

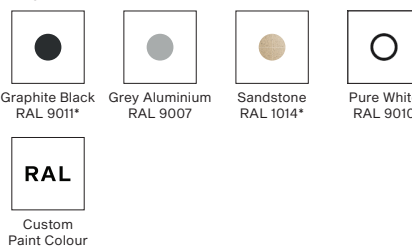

OPTIC OPTIONS

SYMMETRICAL

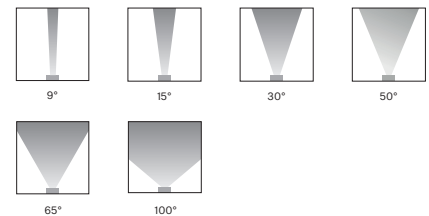

BI-SYMMETRICAL

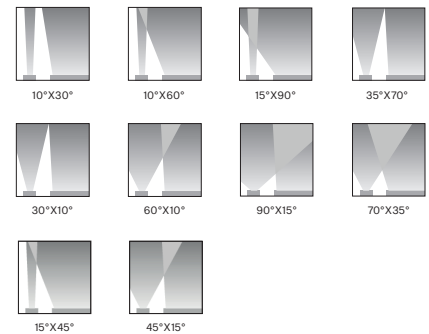

ASYMMETRICAL

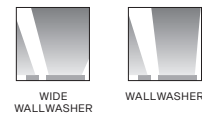

STANDARD & SPECIFICATION

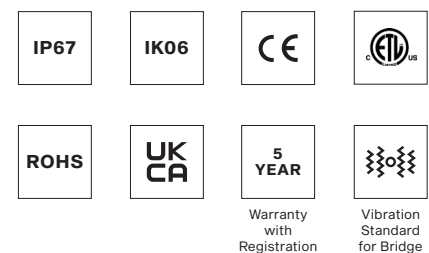

SPECIFICATION

ELECTRICAL	Input Voltage	120 - 277 V AC 50/60 Hz		
	Typical Power Consumption	Eminere 1 / 2 / 3 / 4 : 25 W / 45 W / 65 W / 85 W		
OPTICAL	Light Source	Eminere 1 / 2 / 3 / 4 : 12, 24, 36, 48 x High Power Single Chip LEDs		
	Colour Variants	RGBW (W - 6.500 K)	RGBA	PW (W - 3.000 K)
		Variants On Request: TW (2700 - 6500 K) 2.200 K 2.500 K 2.700 K 3.500 K 4.000 K 5.000 K 6.500 K		
	Beam Angle	Symmetrical:	9° 15° 30° 50° 65° 100°	
		Bi-symmetrical:	10°x30° 30°x10° 10°x60° 60°x10° 35°x70° 70°x35° 15°x90° 90°x15° 15°x45° 45°x15°	
		Asymmetrical:	Wallwasher Wide Wallwasher	
	Lumen Output Delivered	Eminere 1 : 1.147 lm, RGBW @ 9°	Eminere 3 : 3.441 lm, RGBW @ 9°	
Eminere 2 : 2.294 lm, RGBW @ 9°		Eminere 4 : 4.588 lm, RGBW @ 9°		
Projected Lumen Maintenance	L90B10 >90.000 hrs, Ta = 25°C / 77°F			
CONTROL	Interface Protocol	Via E-Box range, Wireless DMX (excluded Eminere 1) or ON/OFF (PW & single color only, No dimming)		
	E-Box Control Protocols	USITT DMX512, RDM, ArtNet, MA Net, MA Net2, sACN, Kling-Net		
	Wireless DMX (Option)	Lumen Radio CRMX Technology		
	Operating Modes	Pixel (12 LEDs/300mm) or Fixture mode		
	Setting / Addressing	Via Two Row LCD Display with Control Buttons or RDM communicator		
	Power Supply	Integrated		
	Connectivity	E-box Lite E-box Daisy	127 of Eminere 1 (@ 230 V and 30m cable) via 1 Output	
		E-box Star	127 of Eminere 1 (@ 230 V and 30m cable) via 6 Outputs	
	Width x Height x Length	Eminere 1 / 2 / 3 / 4	76 x 107 x 329 / 629 / 929 / 1229 mm 2.99 x 3.58 x 12.95 / 24.76 / 36.57 / 48.38 in.	
	Weight	2.5 kg 5.5 lbs	4.0 kg 8.82 lbs	6.02 kg 13.27 lbs
Housing	High Pressure Extruded Aluminium Body End Caps - Die-Cast Aluminium Tempered Glass			
PHYSICAL	Finish Options	Standard Colour	Graphite Black RAL 9011 Grey Aluminium RAL 9007 Pure White RAL 9010 Sandstone RAL 1014	
		Standard Colour Harsh Environment	Graphite Black RAL 9011 Grey Aluminium RAL 9007 Pure White RAL 9010 Sandstone RAL 1014	
	Cost Option	Custom RAL		
Cables / Connections	IP67 Hybrid Connection (Power + Data)			
Mounting Method	Surface Mount With Different Type of Brackets			
Adjustability	+/- 95°			
Protection Factor IK Rating	IP67 / Suitable For Wet Locations IK06			
Cooling System	Convection			
Operating Ambient Temperature	-20 °C / +50 °C (-4 °F / +122 °F)			
Operating Temperature	+67 °C @ Ambient +50 °C (+153 °F @ Ambient +122 °F)			
CERTIFICATION	Listings	ETL / cETL, CE, RoHS, UKCA		
ACCESSORIES	Not Included Items			
	Mounting Brackets	Mounting Brackets 50 100 200 300 mm custom length		
		C-Clamp Adaptor For Eminere 1 2 3 4		
	Cable Covers	Cable Cover For Eminere 1 2 3 4		
	Shields	Shield For Eminere 1 2 3 4		
	Optical Demo Set	Optical Demo Set For Eminere 1 2 3 4		
	Barndoor	Barndoor (with or without Side Covers) for Eminere 1 2 3 4		
		Field Installable Connector FF	Field Installable Connector FM	
	Cables and Connectors	Cable CE WCA	Cable US WCA	
		Waterproof Cover Cap FM ZAHB-0006		
		CE/UL Leader Cables FF for Eminere FF 2 5 10 25 50 m		
		CE/UL Jumper Cables FF/FM for Eminere FF/FM 0,25 0,5 1 2 3 5 10 m		
	Booster Box	Booster Box		

DIMENSIONS

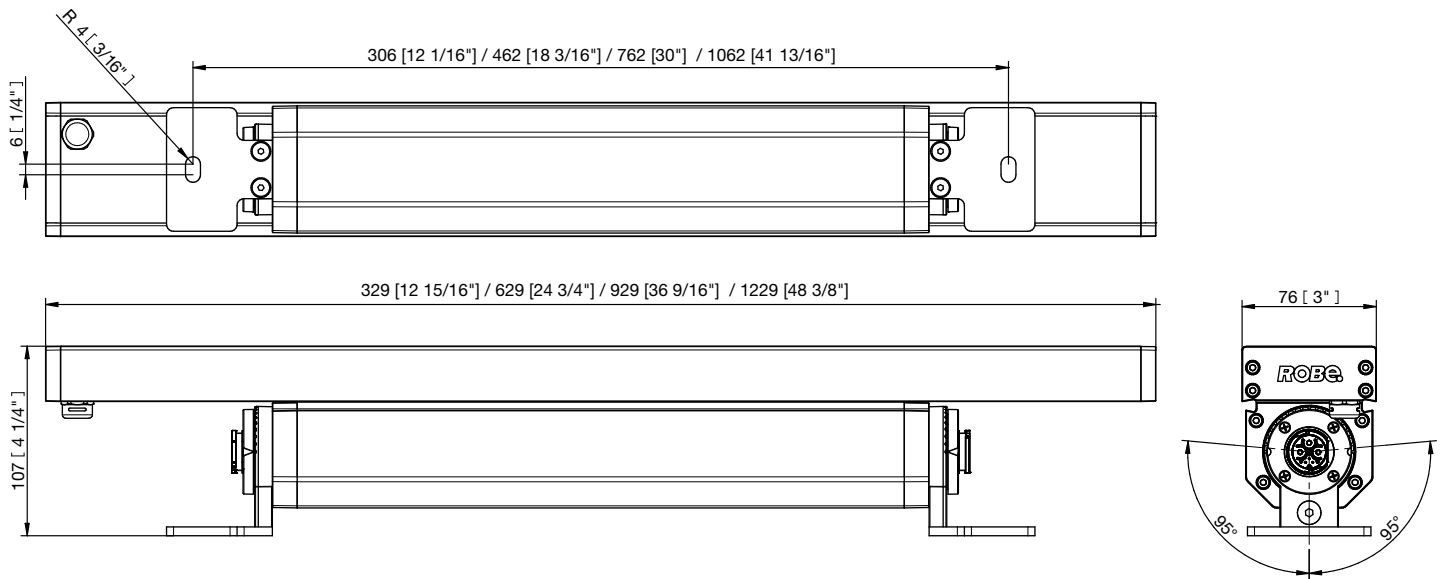

PROJECTED AREA

	Front (rear) - m ²	Front (rear) ft ²	Side - m ²	Side - ft ²	Top - m ²	Top - ft ²
Eminere 1 with Shield with cable cover	0,028 0,049 0,032	0,301 0,527 0,344	0,007 - -	0,075 - -	0,025 0,026 0,026	0,269 0,280 0,280
Eminere 2 with Shield with cable cover	0,045 0,093 0,060	0,484 1,001 0,646	0,007 - -	0,075 - -	0,048 0,049 0,049	0,516 0,527 0,527
Eminere 3 with Shield with cable cover	0,072 0,135 0,087	0,775 1,452 0,936	0,007 - -	0,075 - -	0,071 0,073 0,073	0,764 0,785 0,785
Eminere 4 with Shield with cable cover	0,100 0,178 0,115	1,076 1,915 1,237	0,007 - -	0,075 - -	0,094 0,096 0,096	1,011 1,033 1,033

PHOTOMETRIC OVERVIEW

Based on RGBW version, all leds @ full

	Lumen Output (lm)			
	EMINERE 1	EMINERE 2	EMINERE 3	EMINERE 4
9°	1147	2 294	3 441	4 588
15°	978	1 956	2 910	3 912
30°	1 046	2 092	3 138	4 184
50°	1 039	2 078	3 117	4 156
65°	1 040	2 080	3 120	4 160
100°	996	1 992	2 988	3 984
10° x 30°	1 032	2 064	3 096	4 128
10° x 60°	1 051	1 874	2 811	3 748
15° x 45°	TBC	TBC	TBC	TBC
15° x 90°	970	1 940	2 934	3 880
35° x 70°	1 040	2 080	3 120	4 160
WallWasher	952	1 904	2 856	3 806
Wide WallWasher	854	1 708	2 562	3 416

BI-SYMMETRICAL BEAM ANGLES

Bi-symmetrical: 10°x30°, 10°x60°, 35°x70°, 15°x90°, 15°x45°

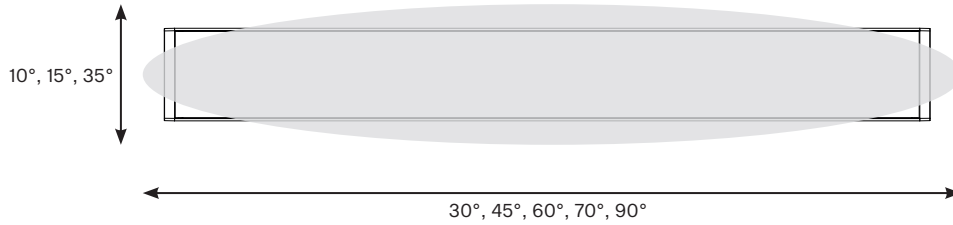

Bi-symmetrical: 30°x10°, 60°x10°, 70°x35°, 90°x15°, 45°x15°

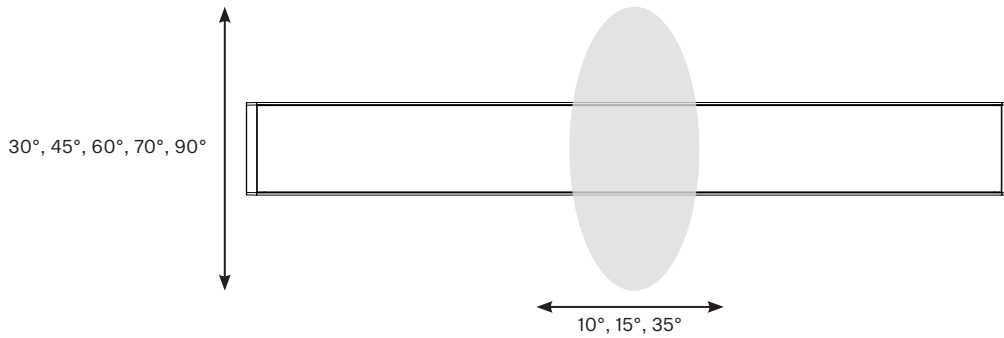

EMINERE WALLWASHER INPUT OPTIONS

STANDARD

UPON REQUEST

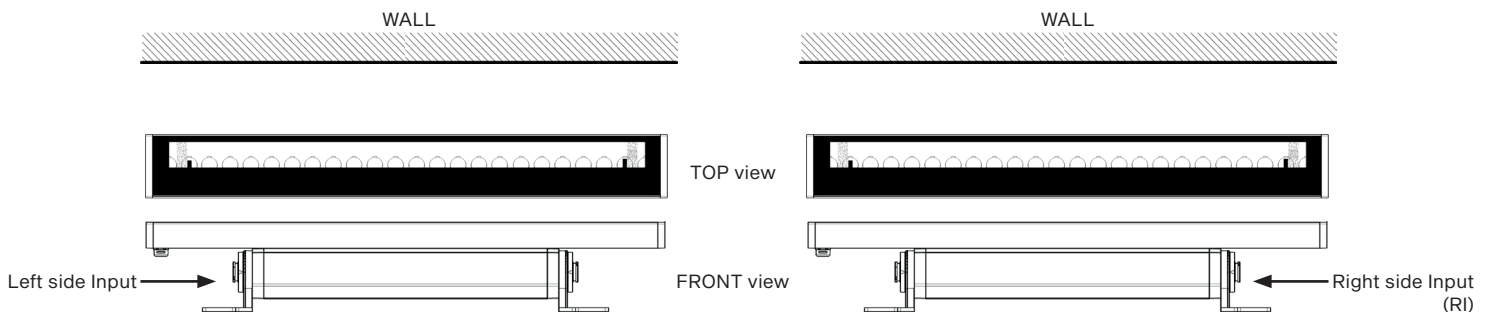

COLOUR MIXING PRINTS

STAND ALONE Specially designed glass printing to achieve optimal colour mixing and intensity distribution.

HEAD2HEAD Fixtures without special end glass print installed right next to each other create absolutely perfect colour and intensity overlap.

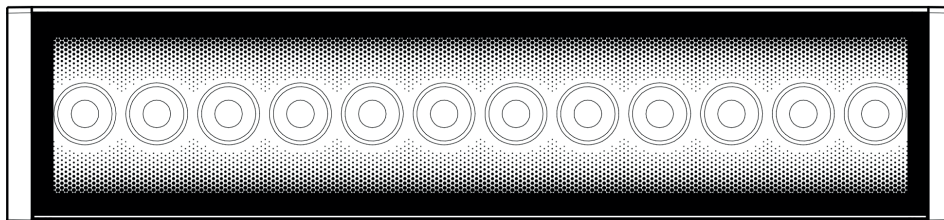

HEAD2HEAD

SYMMETRICAL

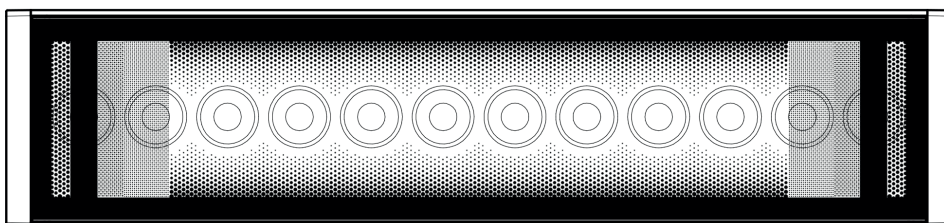

STAND ALONE

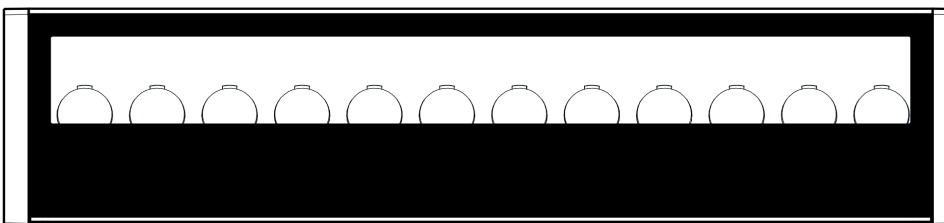

HEAD2HEAD

WALLWASHER

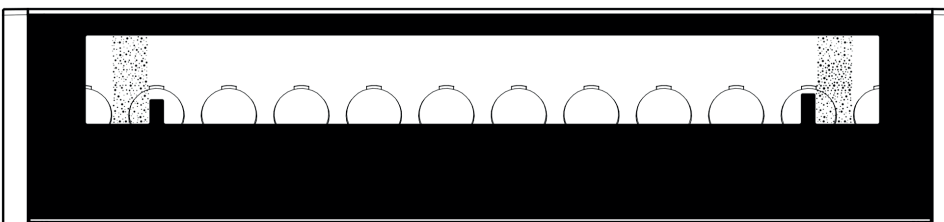

STAND ALONE

Note: Applies for RGBW, RGBA versions. Pure white and Tunable white versions are always without the end print (no matter on their position to other fixture).

E-BOX SPECIFICATION

ELECTRICAL	Input Voltage	120 – 277 V AC 50/60 Hz		
	Wireless DMX (Option)	Lumen Radio CRMX Technology		
	Interface Protocol	E-box Lite: USITT DMX512, RDM		
		E-box Daisy / Star: USITT DMX512, RDM, ArtNet, MA Net, MA Net2, sACN, Kling-Net		
Operating Modes	E-box Lite / Daisy: Fixture Mode, Pixel Mode, Output Mode			
	E-Box Star: Total Mode, Fixture Mode, Pixel Mode, Output Mode			
CONTROL	Display	Via Two Row LCD Display with Control Buttons or RDM communicator		
	Control System	E-box With Self Addressing Feature or Custom Setting Via LCD Display/RDM		
	Power Supply	Integrated		
	Connectivity	E-box Lite	127 of Eminere 1 (@ 230 V and 30m cable) via 1 Output	
		E-box Daisy	127 of Eminere 1 (@ 230 V and 30m cable) via 1 Output	
		E-box Star	127 of Eminere 1 (@ 230 V and 30m cable) via 6 Outputs	
	Length x Width x Height	E-box Lite	220 x 120 x 81 mm (8.66 x 4.72 x 3.18 in.)	
		E-box Daisy	260 x 160 x 91 mm (10.24 x 6.30 x 3.58 in.)	
		E-box Star	280 x 230 x 111 mm (11.02 x 9.06 x 4.37 in.)	
	Weight	1.67 kg 3.85 lbs	2.78 kg 6.13 lbs	4.4 kg 9.7 lbs
Housing	Die-Cast Aluminium Case			
Finish Options	Standard Colour - Graphite Black (RAL 9011) Silver (RAL 9006)			
	Cost Option - Custom RAL Harsh Environment (RAL 9016, RAL 9011)			
Cables / Connections	Cable Grommet (stainless steel)			
Mounting Method	Surface Mount , 4 Mounting Holes			
Protection Factor	IP67 / Suitable For Wet Locations			
IK Rating	IK10			
Cooling System	Convection			
Operating Ambient Temperature	-20 °C / +40 °C (-4 °F / +104 °F)			
CERTIFICATION	Listings	ETL / cETL, CE, RoHS, UKCA		

COMPARISON

	E-BOX LITE	E-BOX DAISY	E-BOX STAR
Power input	1	1	1
Fixture Output	1	1	6
Total load (current)	16A	16A	16A
DMX control	YES	YES	YES
RDM	YES	YES	YES
Art-Net	NO	YES	YES
Ethernet switch	NO	YES	YES
Kling-Net	NO	YES	YES
sACN	NO	YES	YES
MA Net, MA Net2	NO	YES	YES

E-BOX DIMENSIONS

E-BOX LITE

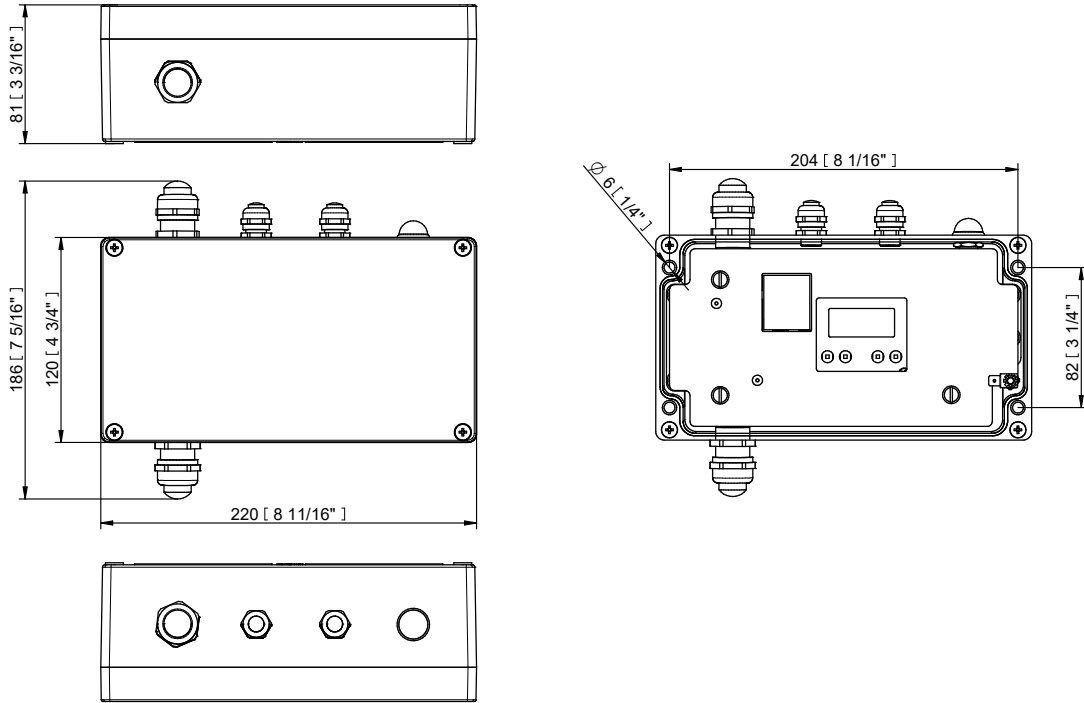

E-BOX DAISY

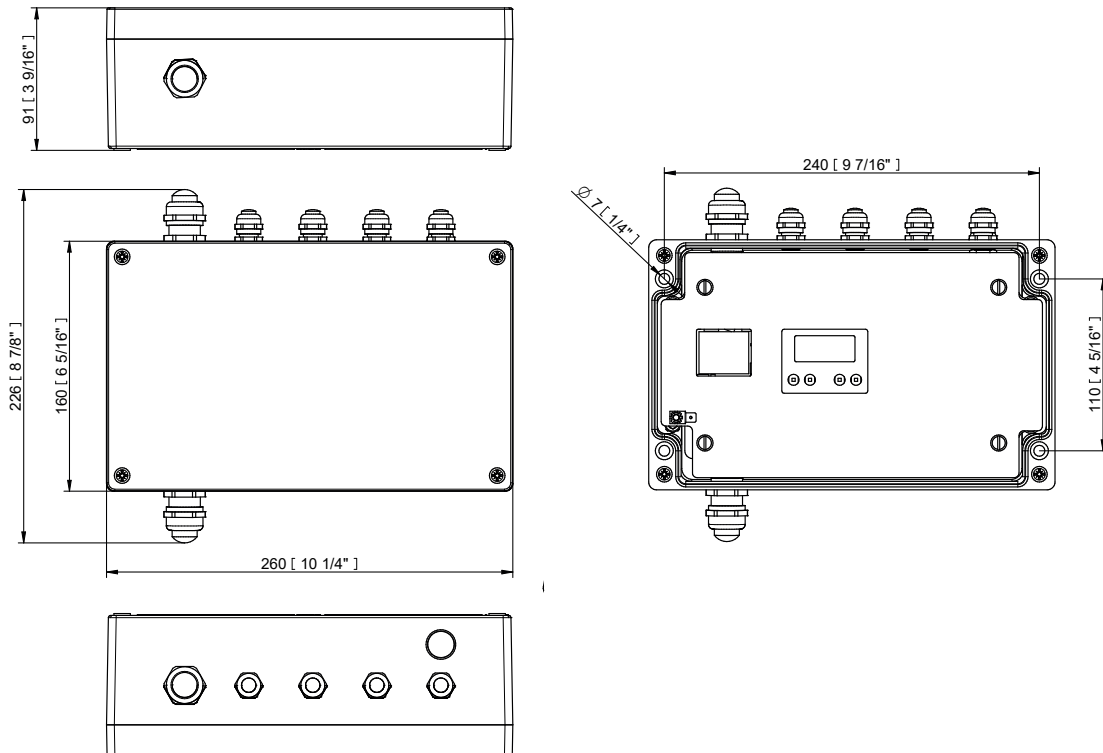

E-BOX STAR

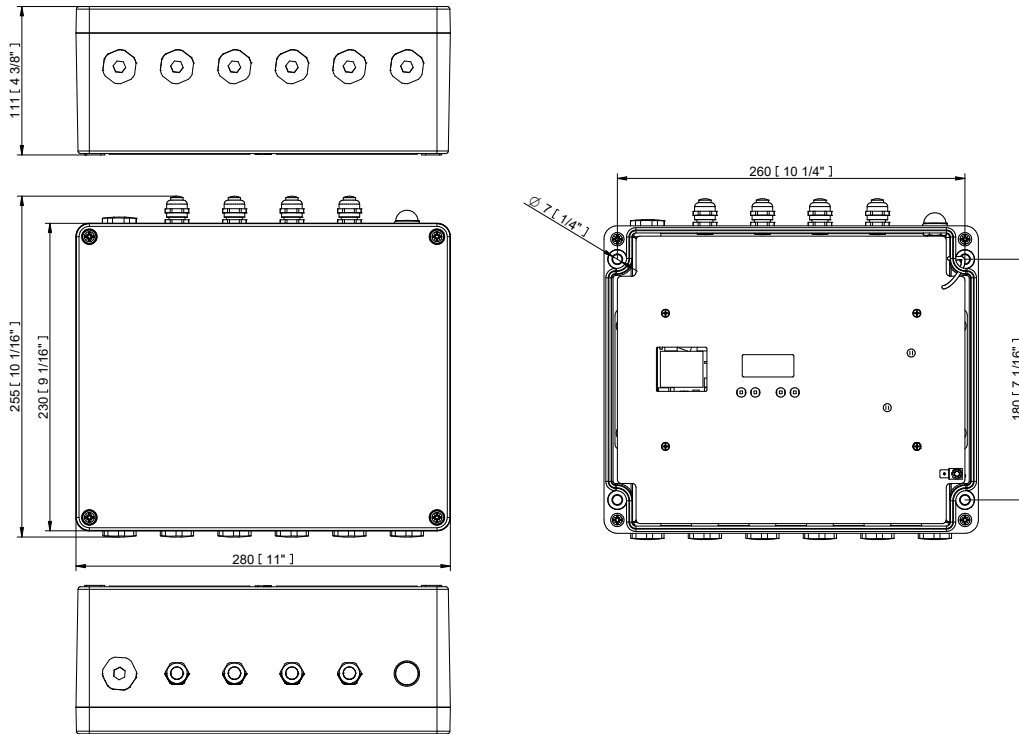

CONNECTIVITY

The tables below state max. theoretical number of Emineres connected to the one LED output of the E-box without using Booster boxes.

	Cable length (m)	Voltage (V)			
		120	190	230	277
EMINERE 1	10	66	104	127	152
	20	66	104	127	152
	30	46	104	127	152
	50	28	70	102	148
	70	20	50	73	106
	100	13	35	51	74
	200	7	17	25	37
EMINERE 2	10	36	56	69	83
	20	36	56	69	83
	30	24	56	69	83
	50	15	38	56	80
	70	10	27	40	57
	100	9	18	28	40
	200	3	9	16	20

	Cable length (m)	Voltage (V)			
		120	190	230	277
EMINERE 3	10	25	40	48	59
	20	25	40	48	59
	30	17	40	48	59
	50	11	26	39	57
	70	7	19	28	40
	100	5	13	19	28
	200	2	6	10	14
EMINERE 4	10	19	31	37	45
	20	19	31	37	45
	30	14	31	37	45
	50	8	20	30	44
	70	5	15	21	35
	100	3	10	15	21
	200	1	4	7	11

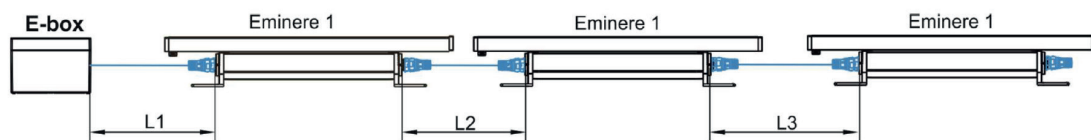

Note: Cable length is a total cable length between E-box and last connected Eminere. Example: Total cable length=L1+L2+L3.
For more information see User Manual.

CONNECTION

E-BOX LITE / DAISY

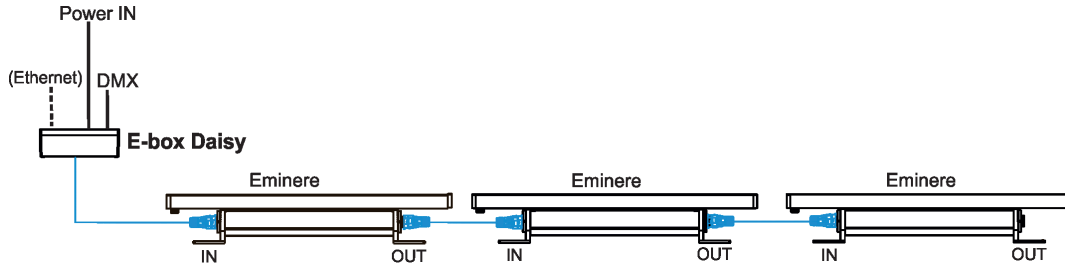

E-BOX STAR

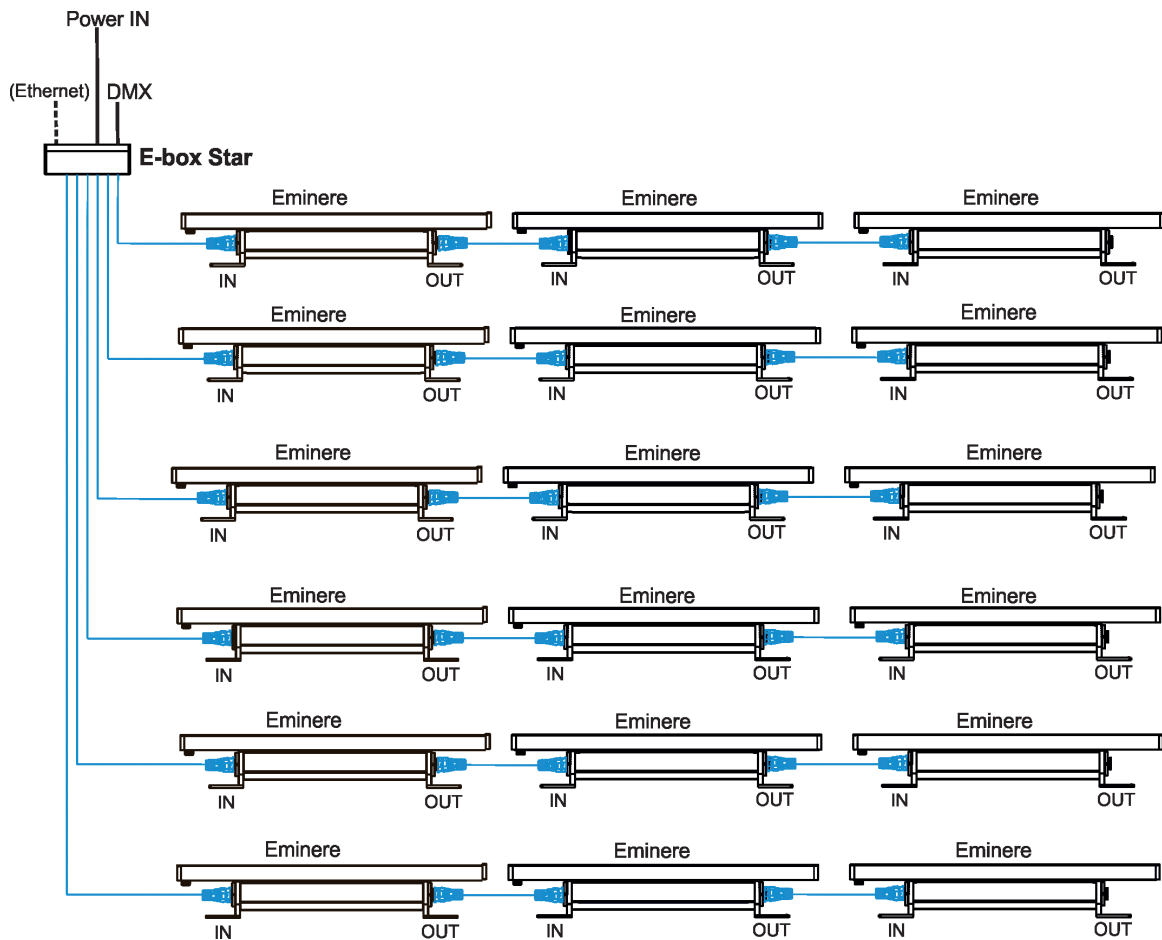

CONNECTION - WIRELESS VERSION

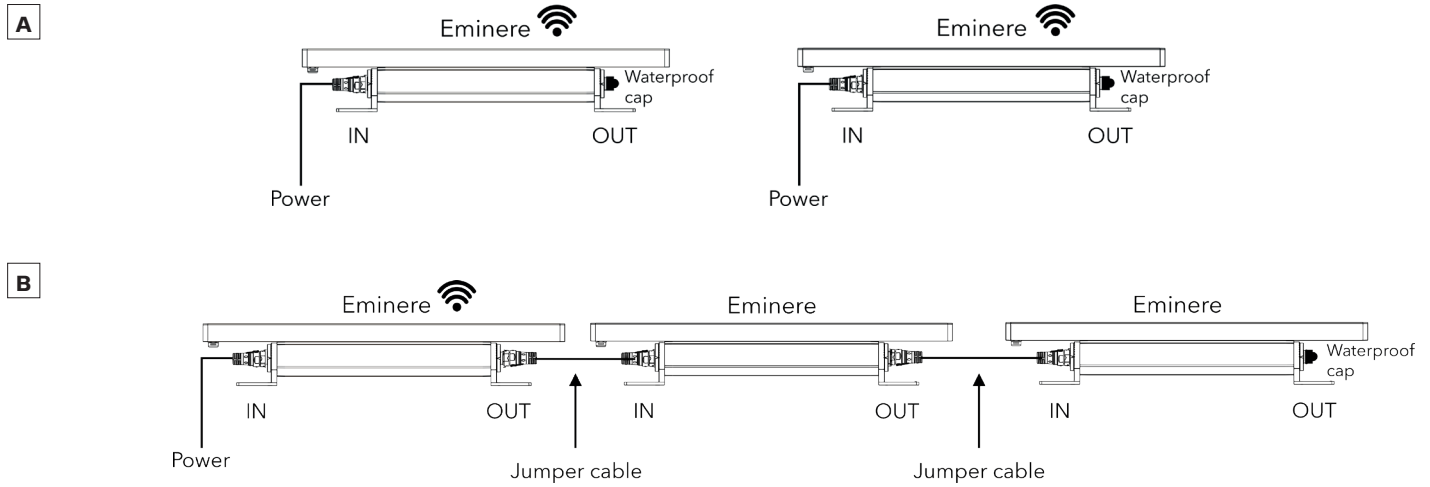

CONNECTION - ON / OFF VERSION

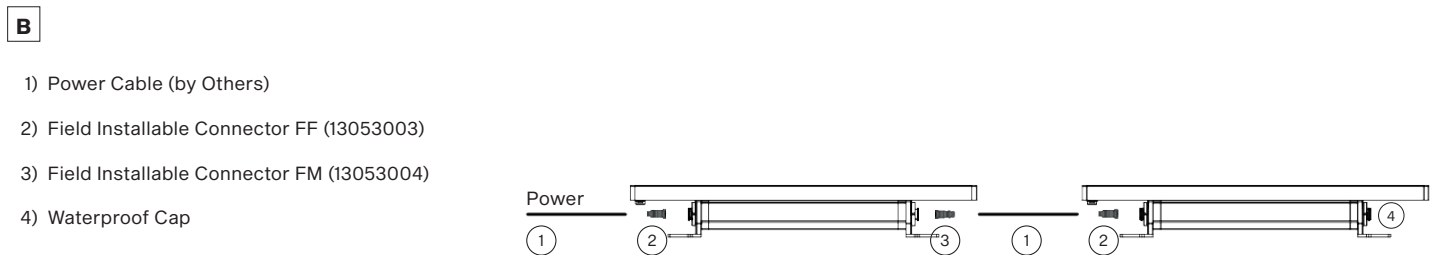
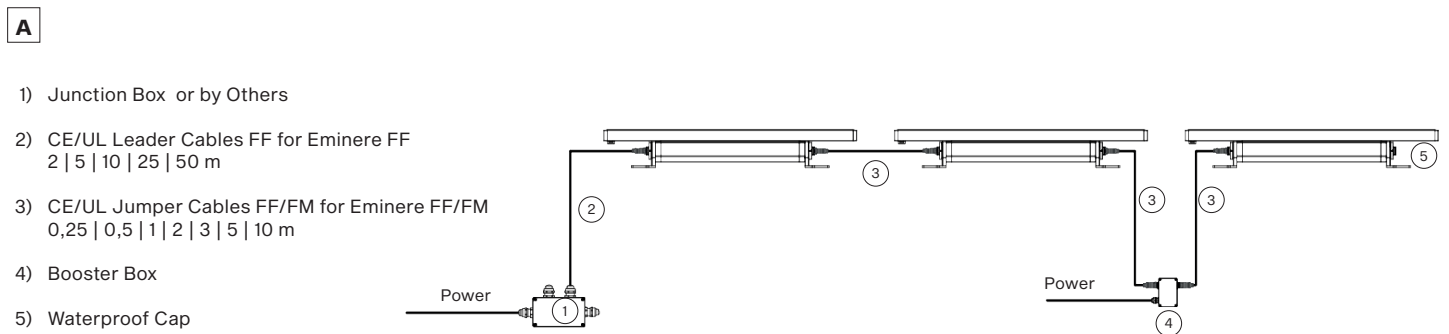

CONNECTION - DALI VERSION (CE)

- 1) Hybrid Cable (1305 3693) Standard with bare-end
- 2) Field Installable Connector FF DC-05 (13053971)
- 3) Eminere DALI with Panel Connector MM(13053975) & Panel Connector MF (13053974)
- 4) Field Installable Connector FM DC-05 (13053973)
- 5) Junction Box

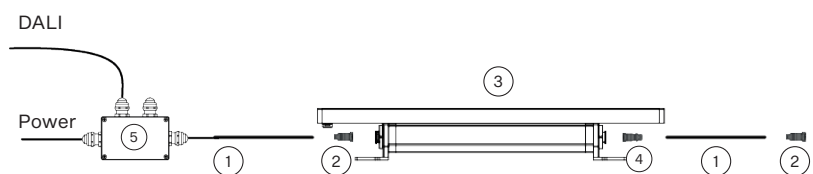

Note: The last unplugged connector must be fitted with a Waterproof Cap to protect the IP rating.

CONNECTION - DALI VERSION (US)

- 1) SJTW 5x 14AWG (13053336), Standard with bare-end, black, or On request Cable SJTW 5x 14AWG (13053697), with bare-end, white
- 2) Field Installable Connector FF DC-05 (13053971)
- 3) Eminere DALI with Panel Connector MM (13053975) & Panel Connector MF (13053974)
- 4) Field Installable Connector FM DC-05 (13053973)
- 5) Junction Box

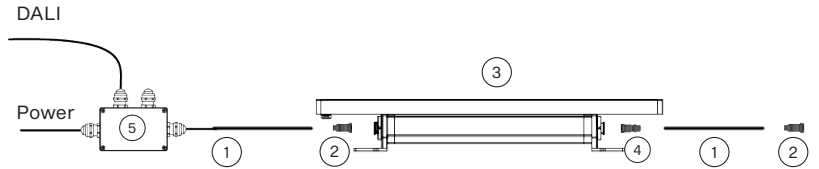

Note: The last unplugged connector must be fitted with a Waterproof Cap to protect the IP rating.

THE BOOSTER BOX

To compensate a voltage drop in a large installation, the Booster boxes have to be connected in the chain of Eminere modules.

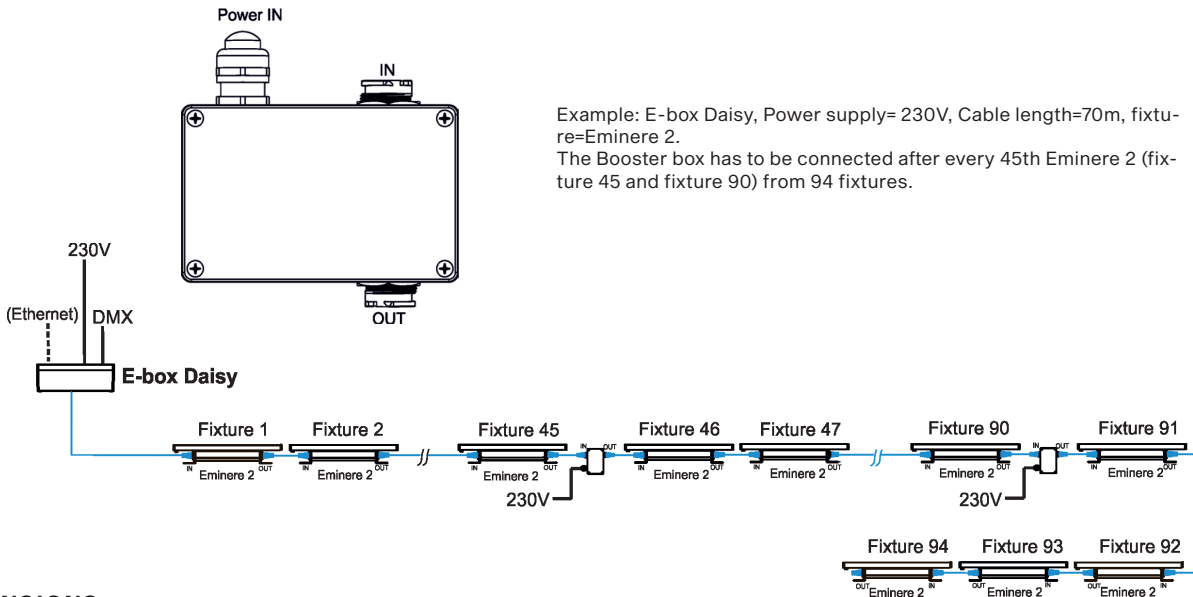

DIMENSIONS

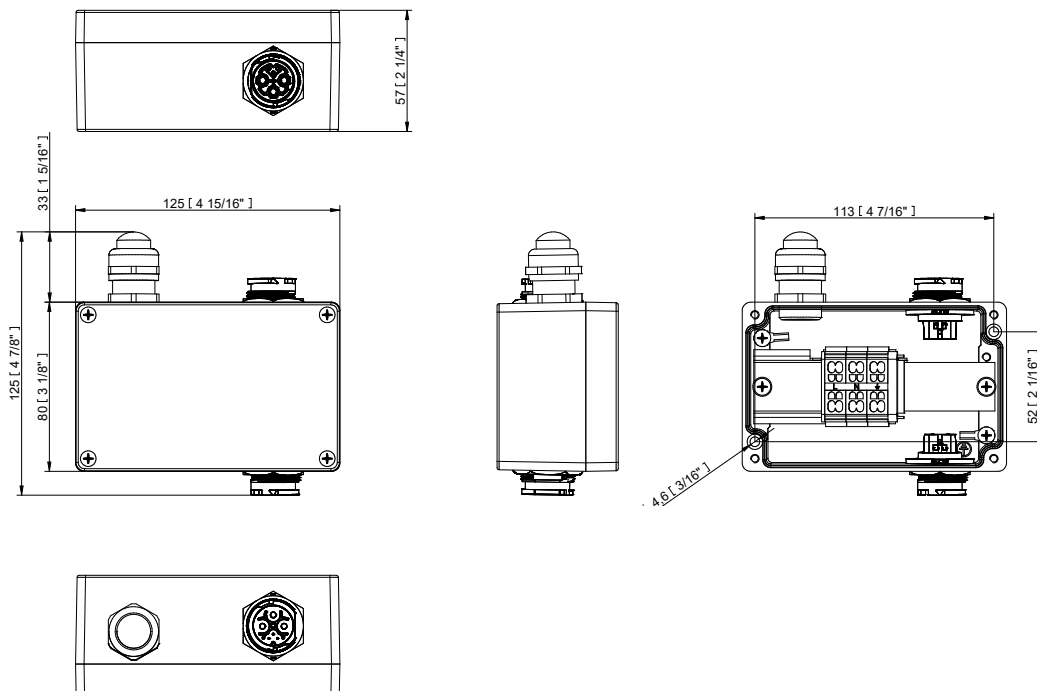

BOOSTER BOX POSITIONS

	Cable length (m)	Max. number of Emineres 1 = 152 (in Standard mode)			
		120 V	190 V	230 V	277 V
EMINERE 1	10 m	66,132	104	127	-
	20 m	66,132	104	127	-
	30 m	46,92,138	104	127	-
	50 m	28,56,84,112,140	70,140	102	148
	70 m	20,40,60,80,100,120,140	50,100,150	73,146	106
	100 m	13,26,39,52,65,78,91,104,117,130,143	35,70,105,140	51,102	74,148
	200 m	7,14,21,28,35,42,49,56,63,70,77,84,91,98,105,112, 119,126,133,140,147	17,34,51,68,85,102,119,136	25,50,75,100,125,150	37,74,111,148

Note: For more detail see the User manual.

ACCESSORIES

Cable Cover for Eminere

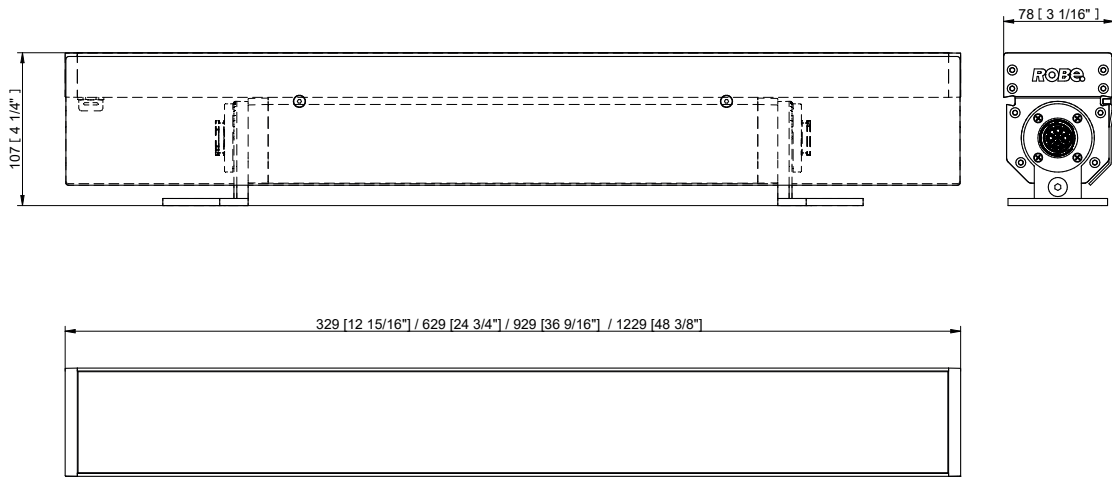

Shield for Eminere

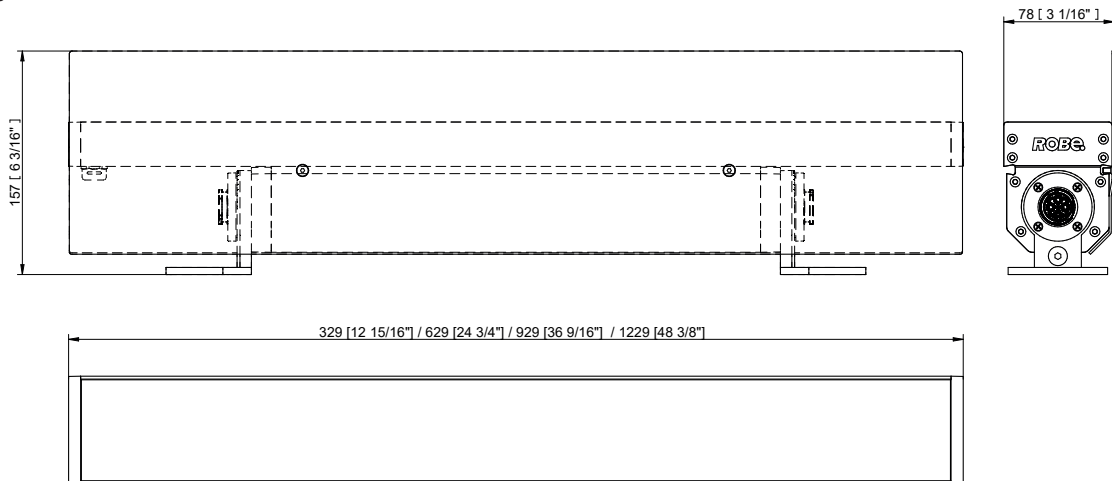

Optical Demo Set

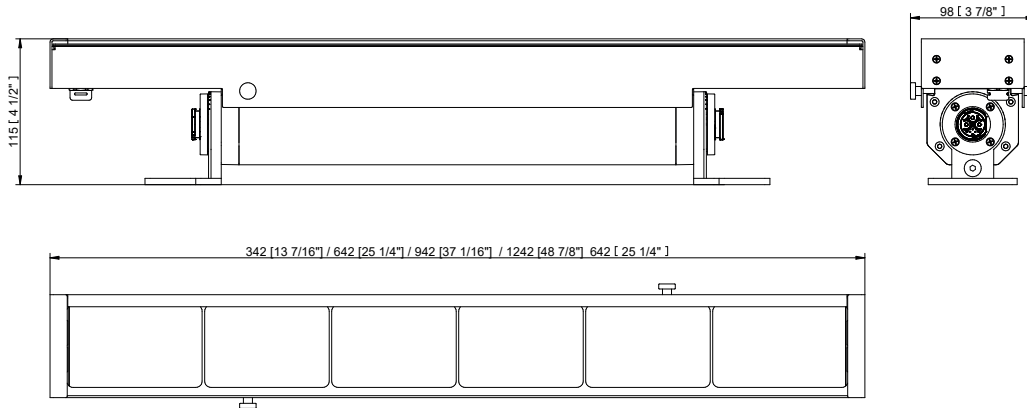

Mounting brackets

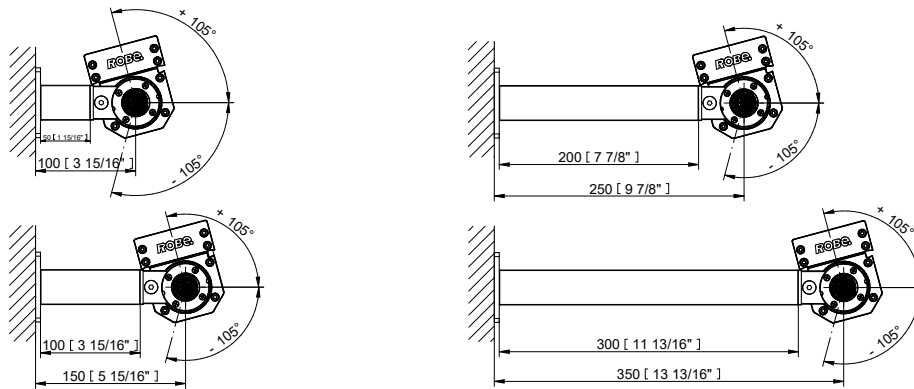

Ceiling Adaptor for Eminere 1 / 2 - custom option

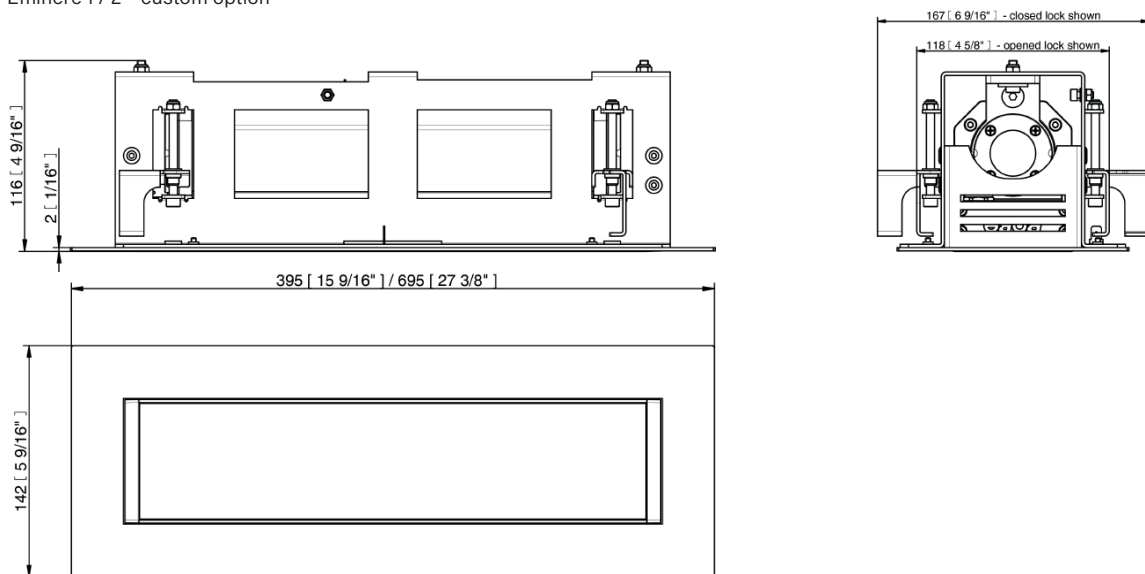

NOTE: This option requires possibility to connect cables to the fixture above a false ceiling. For other connection options please contact the factory.

Barndoor without side covers

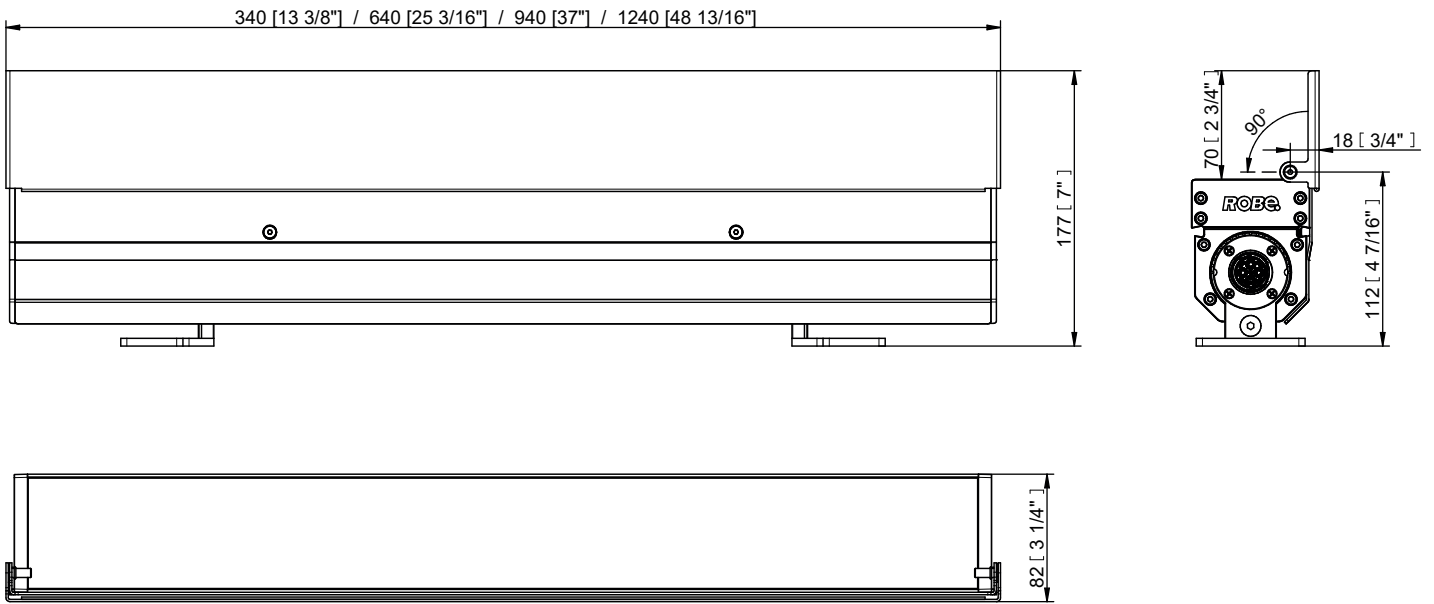

Barndoor with side covers

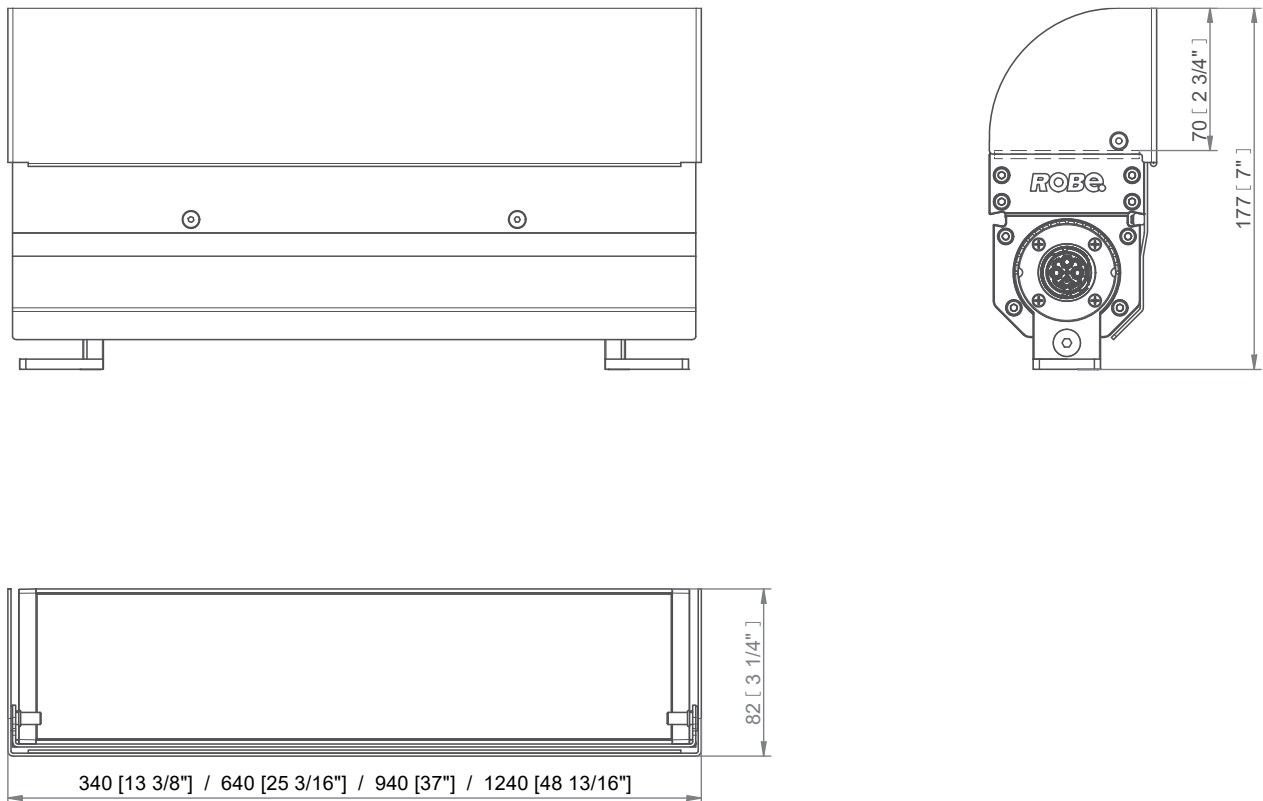

CABLES

Leader Cable

For connecting E-Box with first Eminere. Comes with Waterproof End Cap which has to be installed to the last Eminere's output connector.

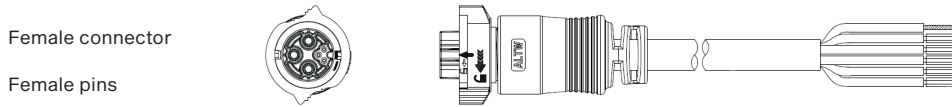

Female connector

Female pins

Jumper Cable

For connection between two Emineres.

NOTE: Custom length of Jumper cable depends on the distance between two Eminere luminaires (length includes cable and connectors).

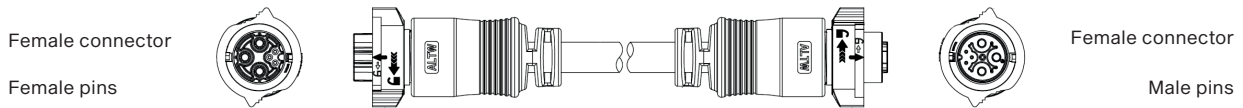

Female connector

Female pins

Female connector

Male pins

Field installable connector

For special cases, where Jumper Cable can't be used. Then use Leader Cable with Field installable connector to make a connection between Emineres.

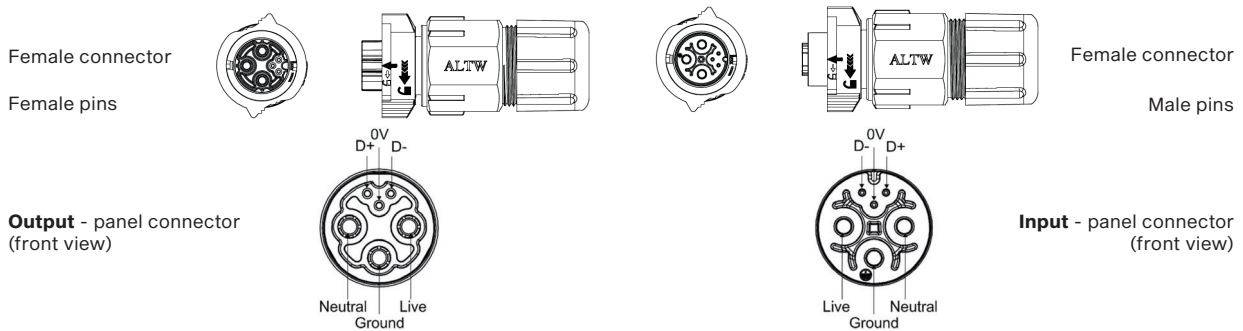

Female connector

Female pins

Female connector

Male pins

Output - panel connector
(front view)



Input - panel connector
(front view)

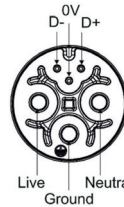

Waterproof End Cap

Install at the end of line to the last Emineres output connector.

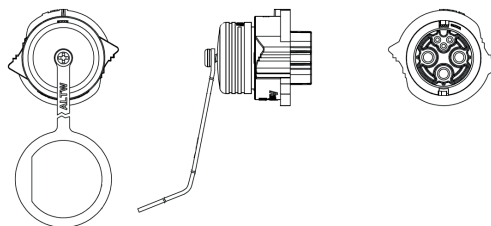

Cable lengths available

IN METRES	LEADER CABLE	JUMPER CABLE
0,25	-	YES
0,5	-	YES
1	-	YES
2	YES	YES
3	-	YES

IN METRES	LEADER CABLE	JUMPER CABLE
5	YES	YES
10	YES	YES
25	YES	-
50	YES	-
Other lengths	On Request	

PHOTOMETRIC DATA

Eminere 4 RGBCW 9dg

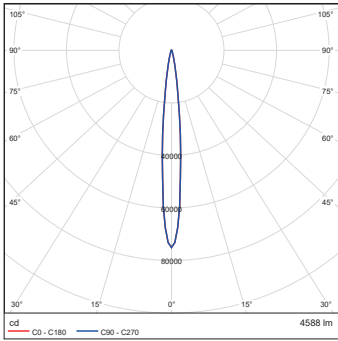

Distance [m]	Cone diameter [m]	E(0°) E(C0)	E(5.3°) E(C270)	Illuminance [lx]
0.50	0.09	300195	148136	
1.0	0.18	75049	37284	
1.5	0.28	33355	16571	
2.0	0.37	18762	9121	
2.5	0.46	12008	5965	
3.0	0.56	8339	4143	

Eminere 4 RGBCW 15dg

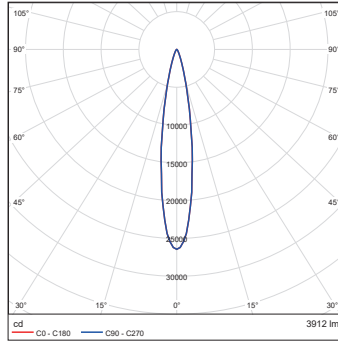

Distance [m]	Cone diameter [m]	E(0°) E(C0)	E(8.9°) E(C270)	Illuminance [lx]
0.50	0.16	105716	51134	
1.0	0.31	26429	12784	
1.5	0.47	11746	5682	
2.0	0.63	6607	3196	
2.5	0.78	4229	2045	
3.0	0.94	2837	1420	

Eminere 4 RGBCW 30dg

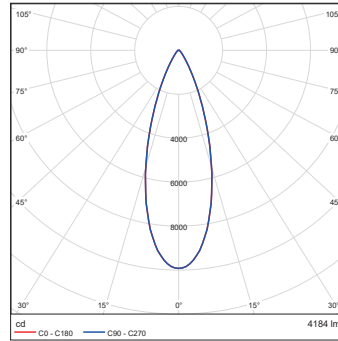

Distance [m]	Cone diameter [m]	E(0°) E(C0)	E(16.9°) E(C270)	Illuminance [lx]
0.50	0.30	39891	17621	
1.0	0.61	9923	4386	
1.5	0.91	4410	1947	
2.0	1.2	2481	1095	
2.5	1.5	1588	701	
3.0	1.8	1103	487	

Eminere 4 RGBCW 50dg

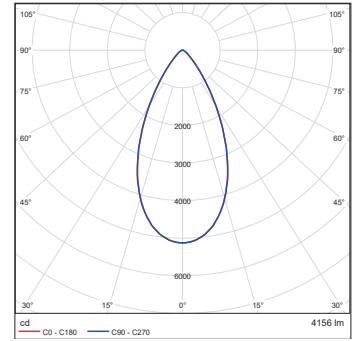

Distance [m]	Cone diameter [m]	E(0°) E(C0)	E(25.7°) E(C270)	Illuminance [lx]
0.50	0.48	2054	7911	
1.0	0.96	512	1978	
1.5	1.4	278	83	
2.0	1.9	128	469	
2.5	2.4	82	300	
3.0	2.9	57	209	

Eminere 4 RGBCW 65dg

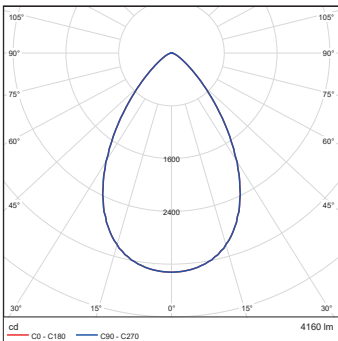

Distance [m]	Cone diameter [m]	E(0°) E(C0)	E(33.6°) E(C270)	Illuminance [lx]
0.50	0.66	13290	3853	
1.0	1.3	3323	963	
1.5	2.0	1477	428	
2.0	2.7	831	241	
2.5	3.3	532	154	
3.0	4.0	399	107	

Eminere 4 RGBCW 100dg

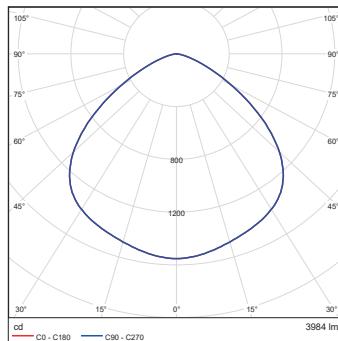

Distance [m]	Cone diameter [m]	E(0°) E(C0)	E(53.6°) E(C270)	Illuminance [lx]
0.50	1.4	6209	662	
1.0	2.7	1542	163	
1.5	4.1	690	72	
2.0	5.4	388	41	
2.5	6.8	248	26	
3.0	8.1	172	18	

PHOTOMETRIC DATA

Eminere 4 RGBCW 10dg x 30dg

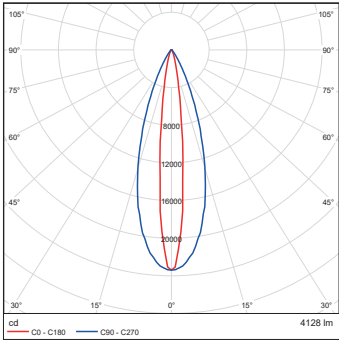

Eminere 4 RGBCW 10dg x 60 dg

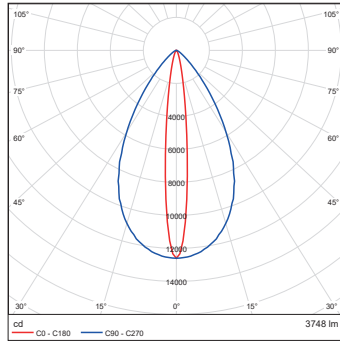

Eminere 4 RGBCW 35dg x 70dg

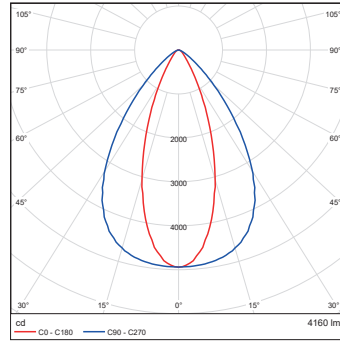

Eminere 4 RGBCW 15dg x 90dg

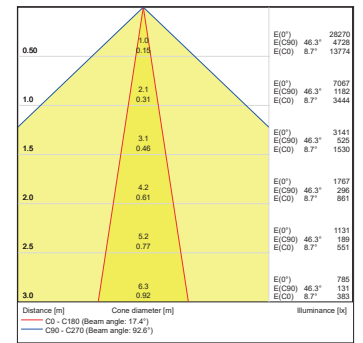
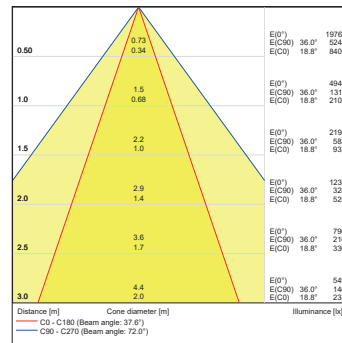
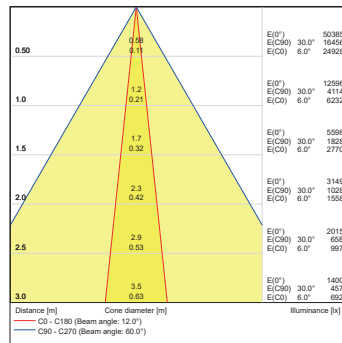
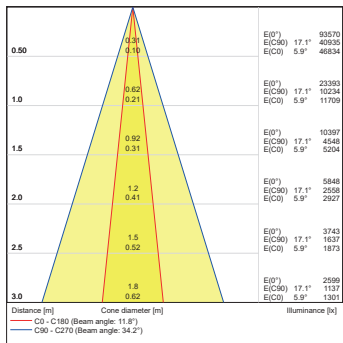
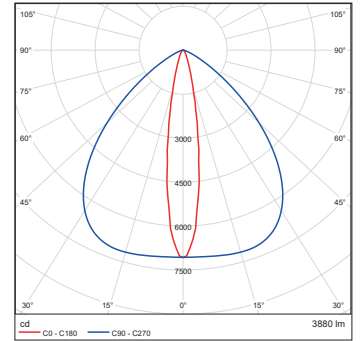

Eminere 4 RGBCW 15dg x 45dg

Eminere 4 RGBCW WallWasher

Eminere 4 RGBCW Wide WallWasher

