

AMBIANE® XP56 RECESSED

Specifically designed for large theatres, concert halls, auditoriums, houses of worship and hotel foyers that require general ambient light, with the added ability to create mood, the Ambiane XP56 Recessed is the ideal, stylish solution. This high-performance RGBW luminaire delivers in excess of 10,000 lm and is perfect for setting the mood via its super-smooth colour mixing abilities. Available in 20°, 30°, 45° or 60° beam spreads, Ambiane XP56 Recessed provides perfect coverage of any area. The incorporation of our L3 (Low Light Linearity) dimming system allows seamless fades to black even when mixed with traditional sources. With no UV or IR emissions making it ideal for museums as well, the fixture is easily controlled via DMX or DALI and is RDM compatible. Ambiane XP56 Recessed has been designed for easy installation and is perfect to retrofit into existing PAR 56 size cut-outs.



KEY FEATURES

LED Output

Available in wide range of colour configurations (RGBW, PW, TW, TD), the Ambiane XP56 Recessed utilises highly-efficient LED modules with CRI 90+ ensuring you can always see every colour as it should be. Through the highest possible luminous flux 10,107 lm, the fixture offers many different beam spreads (20°, 30°, 45° and 60°) for the precise light needed in your lighting installation.

Control

Thanks to our unique L3 (low light linearity) 18-bit dimming system, ultra-smooth fade to black and colour mixing are now possible. The fixture's remote setting and device management is realised through DALI and DMX512 control protocols with RDM support.

Installation

Replacing an old Par 56 has never been easier as Ambiane XP56 Recessed provides an absolutely silent solution thanks to its fanless construction and robust heat sink. Mounted via false ceiling adaptor or standard yoke, it has Trim or Louver as an optional accessory. The low 48 V DC input voltage secure safe light operation and secondary power for back-up lighting.

COLOURS

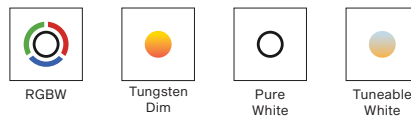

CONTROL & PROTOCOLS



STANDARD & SPECIFICATION

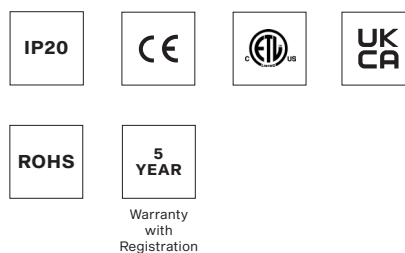

COLOUR TEMPERATURE

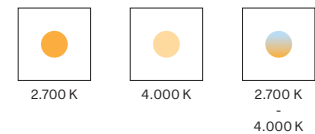

OPTIC OPTIONS

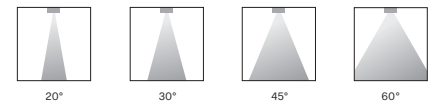

TRIM FINISH OPTIONS

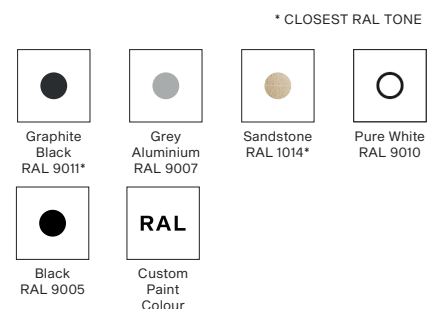

SPECIFICATION

ELECTRICAL	Nominal Input Voltage	48 V DC				
	Input Voltage Range	44 - 50 V DC				
	Maximal Power Consumption	150 W				
OPTICAL	Light Source	High Power LED module				
	Colour Variants	RGBW (W - 2700 K or 4000 K) PureWhite Tunable White Tungsten Dim				
	Colour Temperature of White	PW 2700K or 4000K TW 2700-4000K TD 3200 K				
	CRI	90+				
	Beam Angle	20° 30° 45° 60°				
	Lumen Output Delivered	7.344 lm (RGBNW @ 20° 4000K)	8.865 lm (RGBNW @ 45° 4000K)			
		8.707 lm (RGBNW @ 30° 4000K)	10.107 lm (RGBNW @ 60° 4000K)			
Projected Lumen Maintenance	L90B10 >90.000 hrs, Ta = 25°C / 77°F					
CONTROL	Interface Protocol	Standard: USITT DMX512, RDM, DALI 2, 0-10V		Wireless: Lumen Radio CRMX Technology		
	DALI 2 Device Type	DT 8				
	Control System	ArcControl Range or any Third Party Controller				
	DMX Modes Channels	5 (for RGBW version) 4, 3, 12, 3, 6				
	Setting / Addressing	DIP Switch				
	Power Supply	Ambiane XP56 Recessed: Ambiane Power XP, Ambiane Power Rack or Third Party Constant Voltage 48 V / 150 W Power Supply				
		Ambiane XP56 Recessed /W: Ambiane Power XP, Ambiane Power Rack or Third Party Constant Voltage 48 V / 150 W Power Supply				
		Ambiane XP56 Recessed US: Ambiane Power XP, Ambiane Power Rack US or Third Party Constant Voltage 48 V / 150 W Power Supply				
		Ambiane XP56 Recessed /W US: Ambiane Power XP, Ambiane Power Rack US or Third Party Constant Voltage 48 V / 150 W Power Supply				
	PHYSICAL	Width x Height x Length	Ambiane XP56 Recessed 20°		ø184 x 395 mm (ø7.24 x 15.55 in.)	
Ambiane XP56 Recessed 30°			ø184 x 395 mm (ø7.24 x 15.55 in.)			
Ambiane XP56 Recessed 45°			ø184 x 370 mm (ø7.24 x 14.57 in.)			
Ambiane XP56 Recessed 60°			ø184 x 341 mm (ø7.24 x 13.43 in.)			
Weight		6.2 kg 13.66 lbs	6.2 kg 13.66 lbs	6.02 kg 13.27 lbs	5.9 kg 13 lbs	
Housing		High Pressure Extruded Aluminium Body, Plastic Cover				
Trim Finish Options		Standard Color	Graphite Black RAL 9011 Grey Aluminium RAL 9007 Pure White RAL 9010 Sandstone RAL 1014 Black RAL 9005			
		Cost Option	Custom RAL			
Cables / Connections		Terminal Block (Power In, DMX In/Out, DALI In/Out, Secondary Power)				
Mounting Method		Recessed, Via mounted bracket. Cut-Out Diameter: 186 mm / 7.32 in.				
Protection Factor	IP20 / Dry location only					
Cooling System	Convection					
Operating Ambient Temperature	-20 °C / +40 °C (-4 °F / +104 °F)					
Operating Temperature	+70 °C @ Ambient +40 °C (158 °F @ Ambient 104 °F)					
CERTIFICATION	Listings	ETL / cETL, CE, RoHS , UKCA				
ACCESSORIES	Not Included Items					
	Mounting Accessories	Trim for Ambiane XP56 Recessed				
		False Ceiling Mounting Adaptor				
		Adjustable False Ceiling Mounting Adaptor				
	Optical Accessories	Louver 5° 10° 20° for Ambiane XP56 Recessed				
	Power Supply Options	Ambiane Power XP (MeanWell ELG-240-48-3Y)				
Ambiane Power Rack (CE / US)						

AMBIANE POWER RACK (CE / US) - SPECIFICATION

ELECTRICAL	Input Voltage	100 – 240 V AC 50/60 Hz (Ambiane Power Rack)	100 – 277 V AC 50/60 Hz (Ambiane Power Rack US)
	Maximal Power Consumption	1350 W	
	Output Voltage	48 V DC	
	Outputs	8	
	Max. Load per output	200 W	
	Max. Total Load	1200 W	
	PHYSICAL	Length x Height x Depth	484 (432) x 88 x 241 (202) mm / 19.05 (17) x 3.46 x 9.48 (7.95) in.
Weight		5.4 kg / 11.9lbs	
Housing		Rack Standard - 2U or Wall Mounted Brackets	
Finish Options		Standard Colour - Graphite Black (RAL 9011) Silver (RAL9006)	
		Cost Option - Custom RAL	
Cables / Connections		8 x Terminal Block (DC power Out)	
		1x Main Power Cord (w/plug; CE/US)	
Mounting Method		Designed to Rack Box Installation	
Protection Factor		IP20 / Dry locations only	
Cooling System		Fan Cooled	
Operating Ambient Temperature	-20 °C / +40 °C (-4 °F / +104 °F)		
CERTIFICATION	Listings	ETL / cETL, CE, RoHS , UKCA	

CROSS SECTION OF CONDUCTORS

Recommended cross sections of conductors with respect to distance between Fixture and Power supply.

Distance / Cable length	15m	30m	45m	60m	75m
Cross section of conductors	0.5mm ²	1mm ²	1.5mm ²	2mm ²	2.5mm ²

AMBIANE POWER RACK DIMENSIONS

Ambiane Power Rack (CE / US)

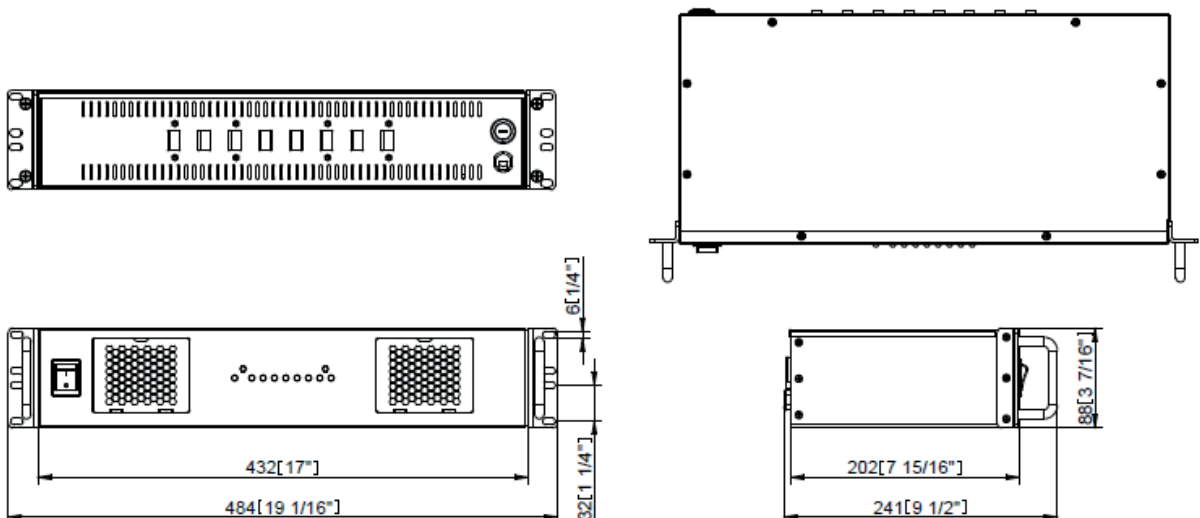

SPECIFICATION SHEET

AMBIANE® XP56 RECESSED

DIMENSIONS

Ambiane XP56 Recessed

H1 20°, 30° = 443 mm [17 7/16 in.]
 H1 45° = 418 mm [16 7/16 in.]
 H1 60° = 389 mm [15 5/16 in.]

H2 20°, 30° = 395 mm [15 9/16 in.]
 H2 45° = 370 mm [14 9/16 in.]
 H2 60° = 341 mm [13 7/16 in.]

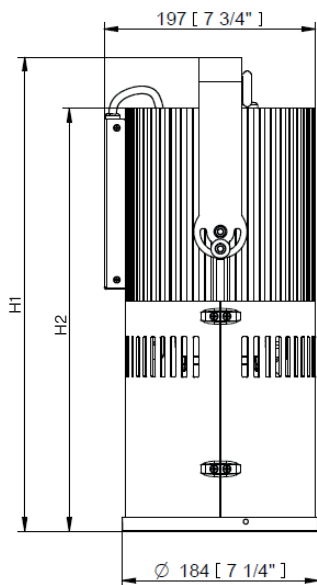

Ambiane XP56 Recessed with Louver 5°, 10°, 20°

L1 Louver 5° = 143 mm [5 5/8 in.]
 L2 Louver 10° = 71 mm [2 3/4 in.]
 L3 Louver 20° = 27 mm [1 1/16 in.]

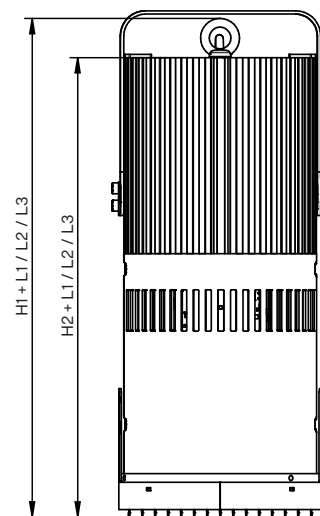

ACCESORIES FOR AMBIANE XP56 RECESSED

Trim for Ambiane XP56 Recessed

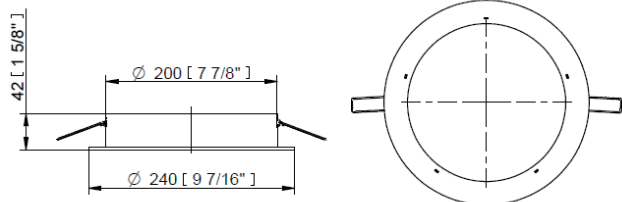

Louver 20° for Ambiane XP56 Recessed

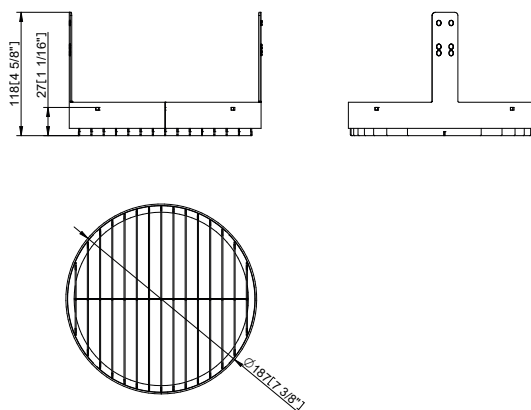

Louver 5° for Ambiane XP56 Recessed

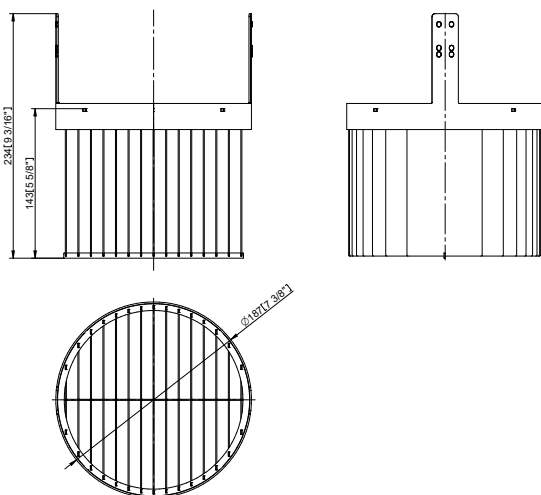

Louver 10° for Ambiane XP56 Recessed

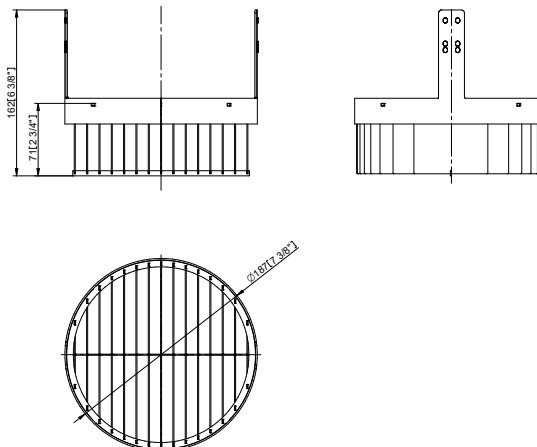

False Ceiling Adaptor for Ambiane XP56 Recessed

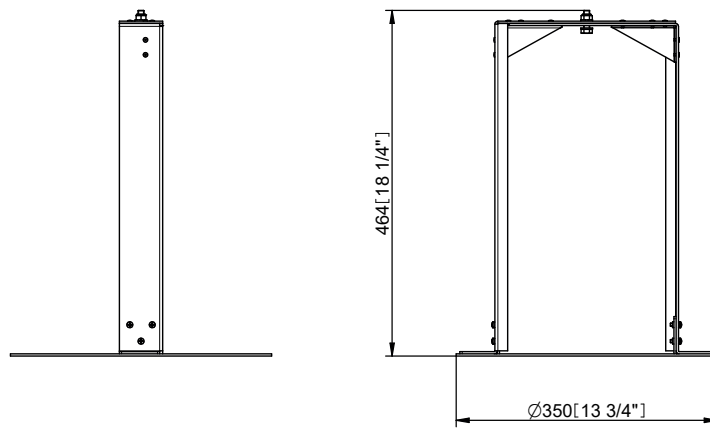
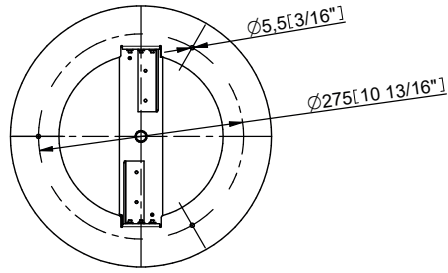

Adjustable False Ceiling Adaptor for Ambiane XP56 Recessed

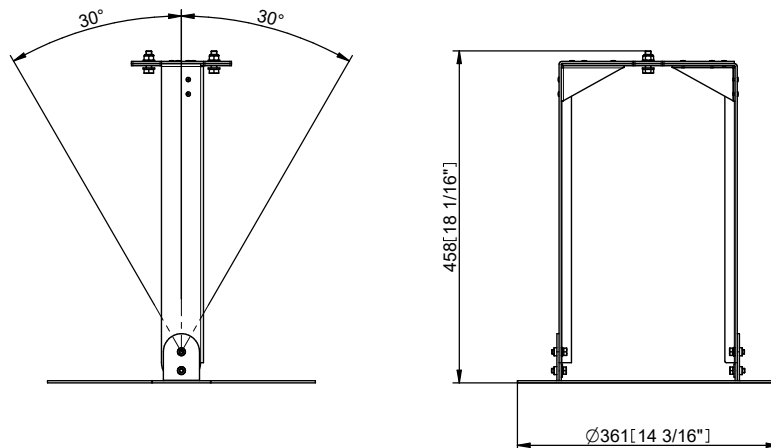
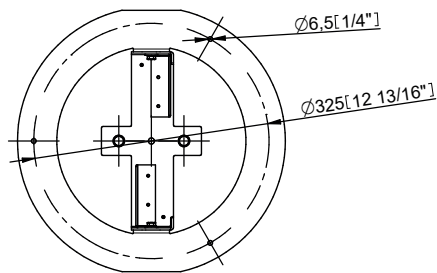

PHOTOMETRIC OVERVIEW

Based on data for Ambiane XP56 Recessed

Lumen Output (lm)

	RGBWW (2700 K)	RGBNW (4000 K)	PW (4000 K)	PW (2700 K)	TW (2700 K - 4000 K)	TD (3200 K)
20°	5 472	7 344	9 432	7 530	5 472 - 7 344	7 401
30°	6 487	8 707	11 182	8 929	6 487 - 8 707	8 774
45°	6 606	8 865	11 386	9 091	6 606 - 8 865	8 935
60°	7 531	10 107	12 981	10 364	7 531 - 10 107	10 186

UNIFIED GLARE RATING (UGR)

UGR	
20°	< 9 UGR
30°	< 10 UGR
45°	< 16 UGR
60°	< 22 UGR

TM30 FOR AMBIANE XP56 RECESSED

NOTE: This is a recommended method for displaying ANSI/IES TM-30-18 information.

RGBWW version

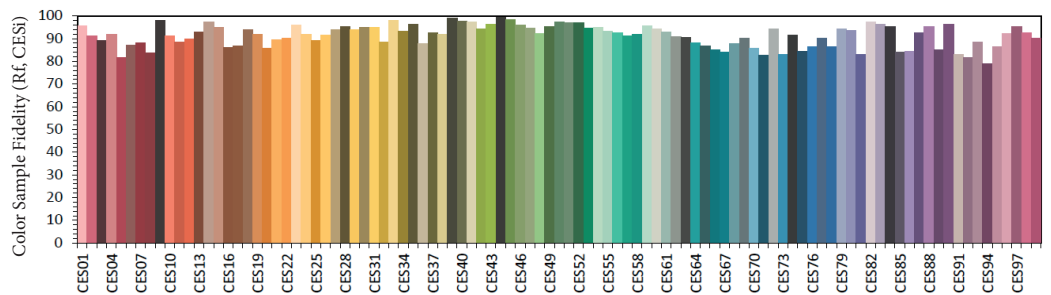
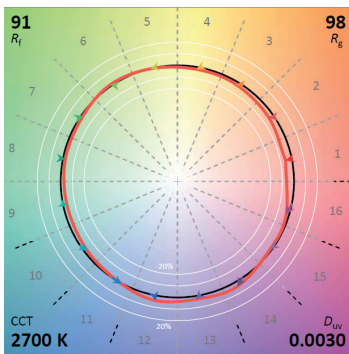

RGBNW version

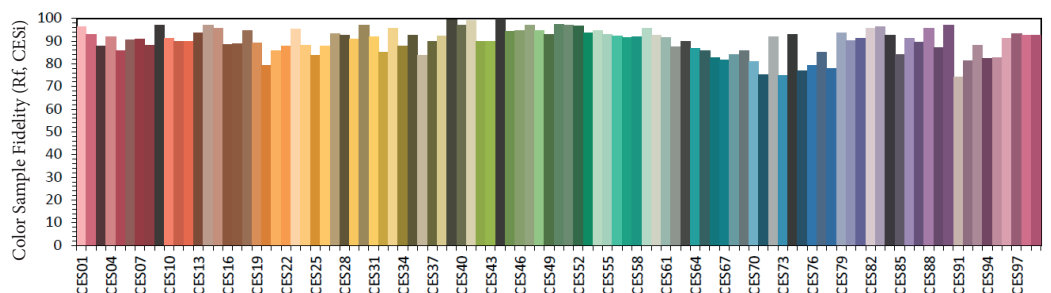
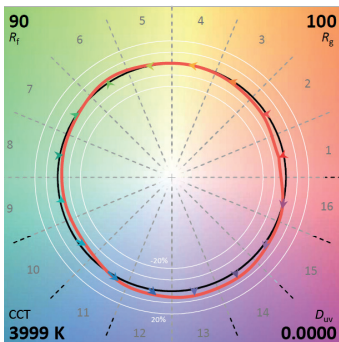

PHOTOMETRIC DATA

Ambiane XP56 RGBWW 20dg

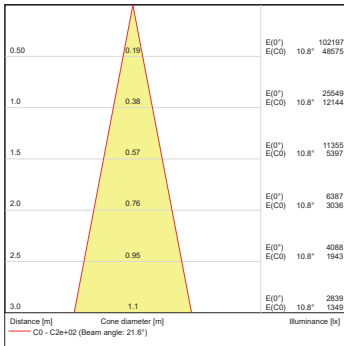
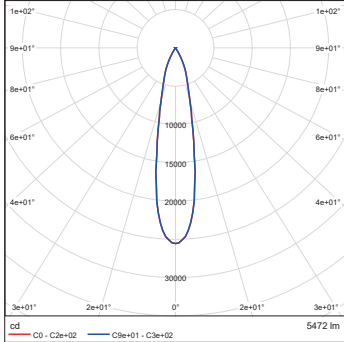

Ambiane XP56 RGBWW 30dg

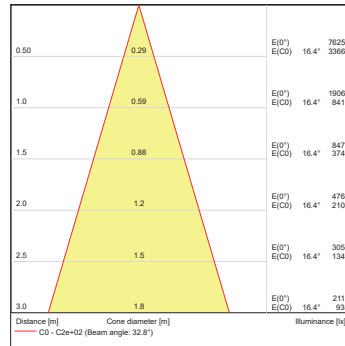
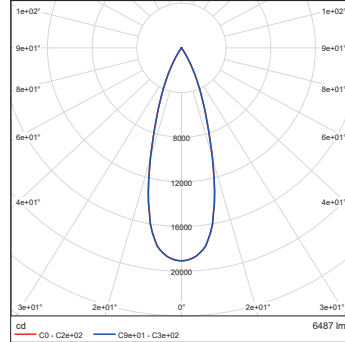

Ambiane XP56 RGBWW 45dg

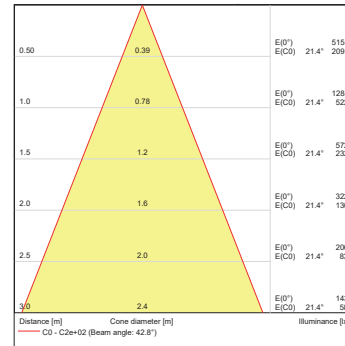
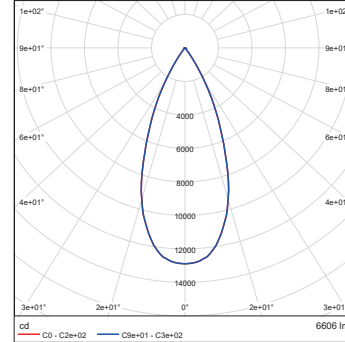

Ambiane XP56 RGBWW 60dg

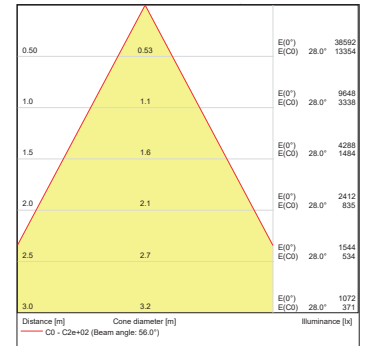
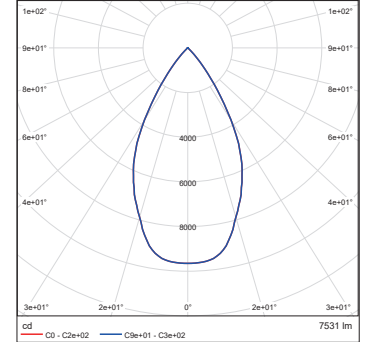

Ambiane XP56 RGBNW 20dg

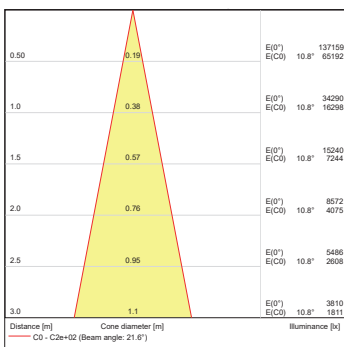
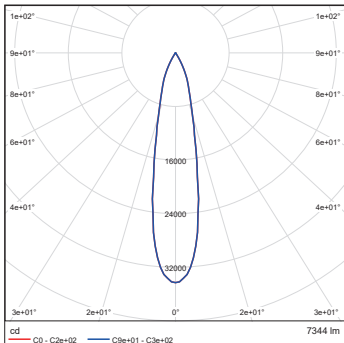

Ambiane XP56 RGBNW 30dg

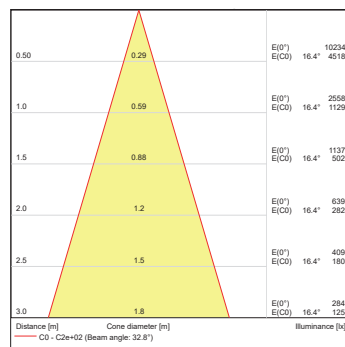
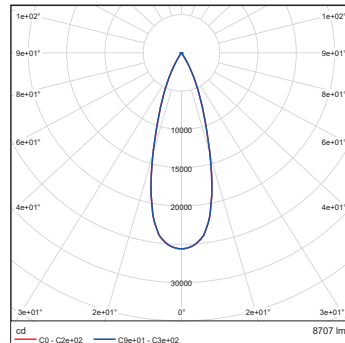

Ambiane XP56 RGBNW 45dg

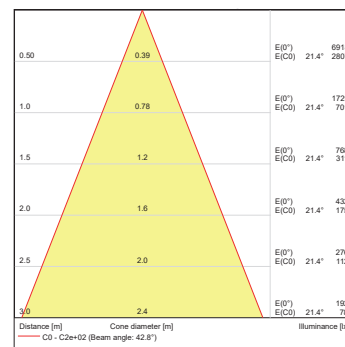
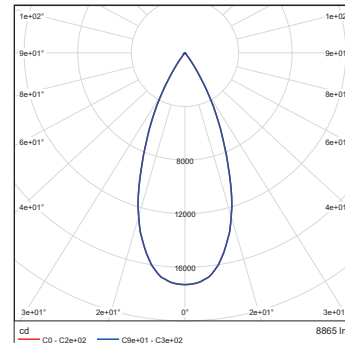

Ambiane XP56 RGBNW 60dg

