

# AMBIANE® HP111 SURFACE MOUNT

Surface mount version of Ambiane is ideal for mid-throw application onto a levelled ceiling. Same light source specification hidden inside of the beautiful design makes this fixture an ideal add-on to lighting design of Ambiane series. Giving designers and installers a choice of 20, 40, 60 or 80-degree optical beam spreads, the Ambiane HP111 provides an endless array of positioning options across an entire installation. The incorporation of our L3 (Low Light Linearity) dimming system allows seamless fades to black even when mixed with traditional sources. With no UV or IR emissions which make it ideal for museums as well, the fixture is easily controlled via DMX or DALI and is RDM compatible.



## KEY FEATURES

### LED Output

Available in wide range of colour configurations (RGBW, PW, TW, TD), the Ambiane HP111 Surface Mount utilises highly efficient LED modules with CRI 90+ ensuring you can always see every colour as it should be. Equally homogenised light output is secured by precisely designed output optics with the highest possible luminous flux 3239 lm and a 90,000 LED lifetime which guarantees low maintenance cost and long light output. The fixture offers many different beam spreads (20°, 40°, 60° and 80°) for the precise light needed in your lighting installation.

### Control

Thanks to our unique L3 (low light linearity) 18-bit dimming system, exceptionally smooth fade to black and colour mixing are now possible. The fixture's remote setting and device management is realised through DALI and DMX512 control protocols with RDM support and intelligent power balancing (always 75 W output in any mixed colour).

### Installation

An ideal replacement for an outdated AR111 fixture, the Ambiane HP111 Surface Mount offers the possibility of a backup power connection to protect against any unexpected blackout and operate as emergency lighting.

## COLOURS

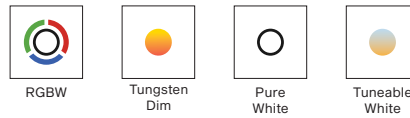

## CONTROL & PROTOCOLS



## STANDARD & SPECIFICATION

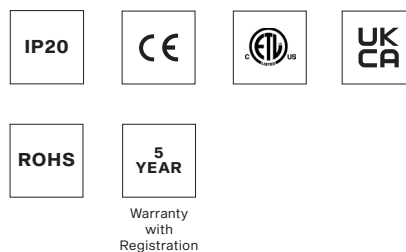

## COLOUR TEMPERATURE

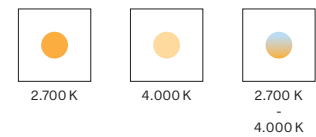

## OPTIC OPTIONS

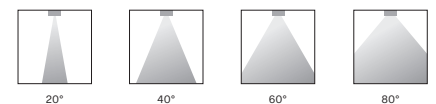

## FINISH OPTIONS

\* CLOSEST RAL TONE

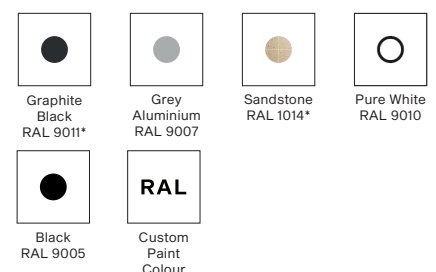

**AMBIANE HP111 SURFACE MOUNT SPECIFICATION**

<b>ELECTRICAL</b>	Input Voltage	48 V DC		
	Input Voltage range	44-50 V DC		
	Max. Power Consumption (Primary power   Secondary power)	75 W   20 W		
	Max. Operating time for Sec. power	3 hours		
<b>OPTICAL</b>	Light Source	High Power LED module		
	Colour Variants	RGBW (W 2700 K or 4000 K)	Pure White	Tunable White   Tungsten Dim
	Colour Temperature of White	PW 2700 K or 4000 K   TW 2700-4000 K   TD 3200 K		
	CRI	90+		
	Beam Angle	20°   40°   60°   80°	20° With Ring Louver for Ambiane HP111	
	Lumen Output Delivered	2.289 lm (RGBNW at 20° 4000 K)		3.239 lm (RGBNW at 60° 4000 K)
		3.024 lm (RGBNW at 40° 4000 K)		3.145 lm (RGBNW at 80° 4000 K)
	Projected Lumen Maintenance	L90B10 >90.000 hrs, Ta = 25°C / 77°F		
<b>CONTROL</b>	Interface Protocol	USITT DMX512, RDM, DALI 2, 0-10 V		
	DALI 2 Device Type	DT 8		
	Control System	ArcControl Range or any Third Party Controller		
	DMX Modes   DNX Channels	5 (for RGBW version)   4, 3, 12, 3, 6		
	Settings / Addressing	DIP Switch		
	Power Supply	Ambiane Power HP (48 V / 100 W)	Ambiane Power Rack (CE/US)	
<b>PHYSICAL</b>	Width x Height x Depth   Weight	Ambiane HP111 Surface Mount 20° - ø129 x 302 mm (ø5.08 x 11.9 in.)		3.1 kg   6.8 lbs @ 20°
		Ambiane HP111 Surface Mount 40° - ø129 x 298 mm (ø5.08 x 11.73 in.)		3.1 kg   6.8 lbs @ 40°
		Ambiane HP111 Surface Mount 60° - ø129 x 285 mm (ø5.08 x 11.22 in.)		3 kg   6.6 lbs @ 60°
		Ambiane HP111 Surface Mount 80° - ø129 x 268 mm (ø5.08 x 10.55 in.)		3 kg   6.6 lbs @ 80°
	Housing	High Pressure Extruded Aluminium Body		
	Finish Options	Standard Color	Graphite Black RAL 9011   Grey Aluminium RAL 9007 Pure White RAL 9010   Sandstone RAL 1014   Black RAL 9005	
		Cost Option	Custom RAL	
	Cables / Connections	Terminal block (Power In, DMX In/Out, DALI In/Out, Secondary Power Input)		
	Mounting Method	Via Mounting Adaptor		
	Protection Factor	IP20 / Dry location only		
	Cooling System	Convection		
	Operating Ambient Temperature	-20 °C / +40 °C (-4 °F / +104 °F)		
	Max. Operating Temperature	+75°C (167°F)		
	<b>CERTIFICATION</b>	Listings	ETL / cETL, RoHS, CE (including ČSN EN 60598-2-22 / Emergency lighting, ISO17067), UKCA	
<b>ACCESSORIES</b>	<b>Included Items</b>			
	Control Unit			
	<b>Not Included Items</b>			
	Ring Louver 20° (Factory Fitted) Ambiane Power Rack (CE/US) Ambiane Power HP (MeanWell ELG-100-48-3Y)			

DIMENSIONS

Ambiane HP111 Surface Mount (with Ring Louver)

Ambiane HP 20° H = 302 mm [11 7/8 in.]  
 Ambiane HP 40° H = 298 mm [11 3/4 in.]  
 Ambiane HP 60° H = 285 mm [11 1/4 in.]  
 Ambiane HP 80° H = 268 mm [10 9/16 in.]

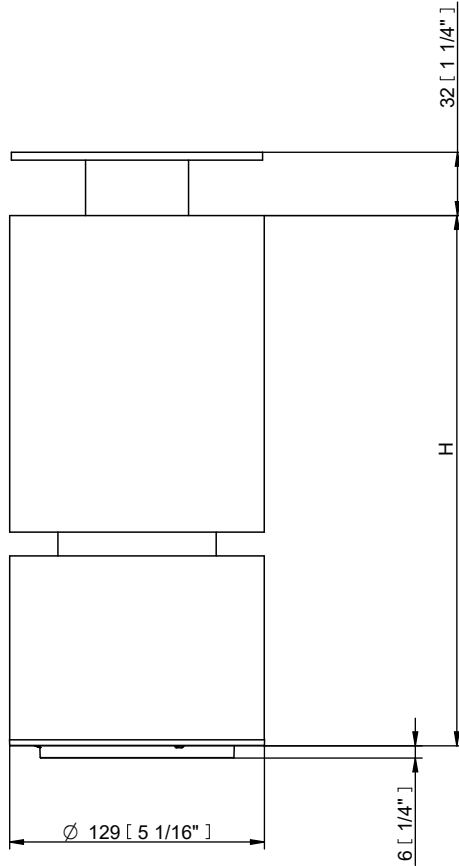

Ambiane HP111 w/Connection Unit

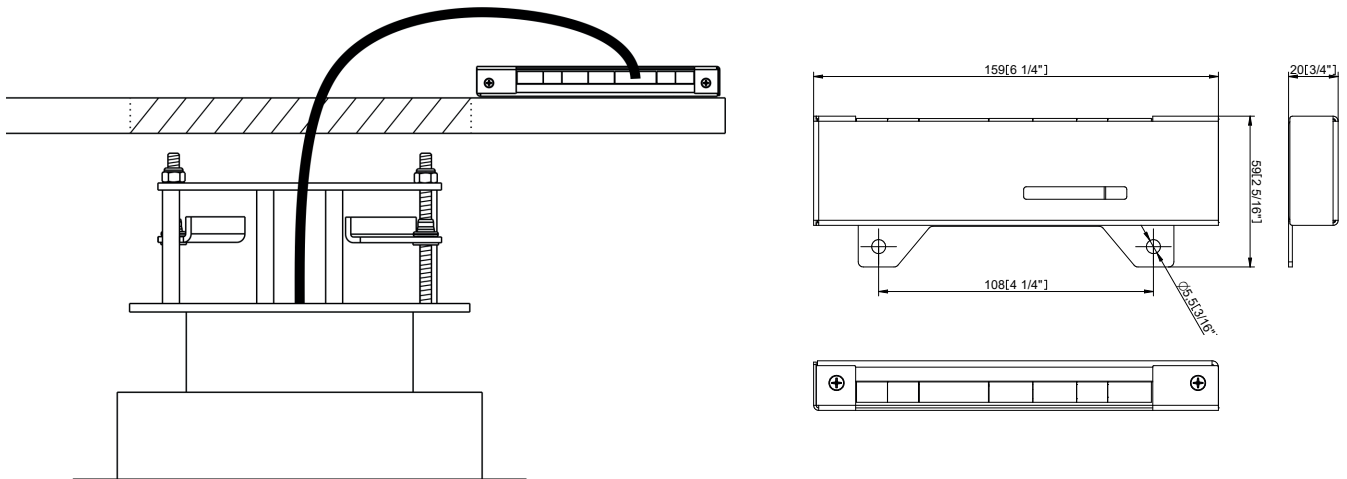

**CROSS SECTION OF CONDUCTORS**

Recommended cross section of conductors with respect to distance between Fixture and Power supply.

Distance / Cable length	25 m	50 m	75 m	100 m
Cross section of conductors	0.5 mm <sup>2</sup>	1 mm <sup>2</sup>	1.5 mm <sup>2</sup>	2 mm <sup>2</sup>

**AMBIANE POWER RACK (CE / US) SPECIFICATION**

<b>ELECTRICAL</b>	Input Voltage	100 – 240 V AC 50/60 Hz (Ambiane Power Rack)
		100 – 277 V AC 50/60 Hz (Ambiane Power Rack US)
	Maximal Power Consumption	1350 W
	Output Voltage	48 V DC
	Outputs	8
	Max. Load per output	200 W
	Max. Total Load	1200 W
<b>PHYSICAL</b>	Length x Height x Depth	484 / 432 x 88 x 241 / 202 mm (19.05 / 17 x 3.46 x 9.48 / 7.95 in.)
	Weight	5.4 kg   11.9lbs
	Housing	Rack Standard - 2U or Wall Mounted Brackets
	Finish Options	Standard Colour - Graphite Black (RAL 9011)   Silver (RAL9006)
		Cost Option - Custom RAL
	Cables / Connections	8 x Terminal Block (DC power Out)
		1x Main Power Cord (w/plug; CE/US)
	Mounting Method	Designed to Rack Box Installation
	Protection Factor	IP20 / Dry locations only
	Cooling System	Fan Cooled
Operating Ambient Temperature	-20 °C / +40 °C (-4 °F / +104 °F)	
<b>CERTIFICATION</b>	Listings	ETL / cETL, CE, RoHS , UKCA

**DIMENSIONS**

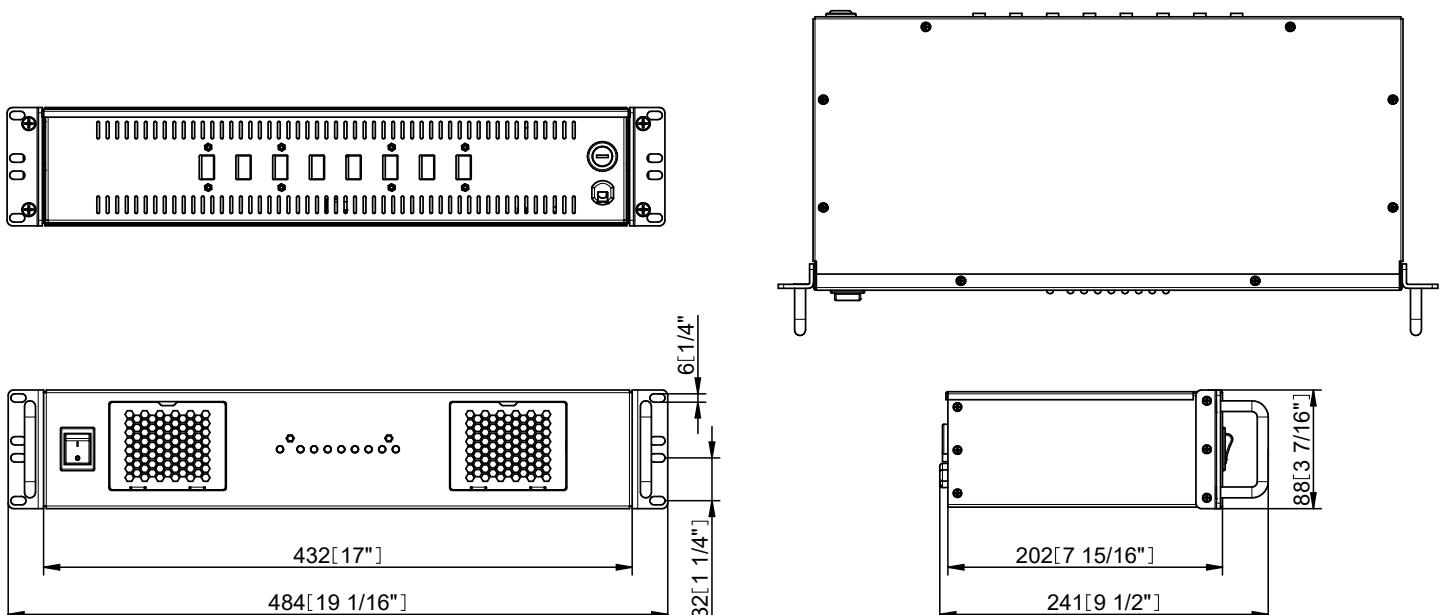

**TM30 FOR AMBIANE HP111**

**NOTE:** This is a recommended method for displaying ANSI/IES TM-30-18 information.

**RGBWW VERSION**

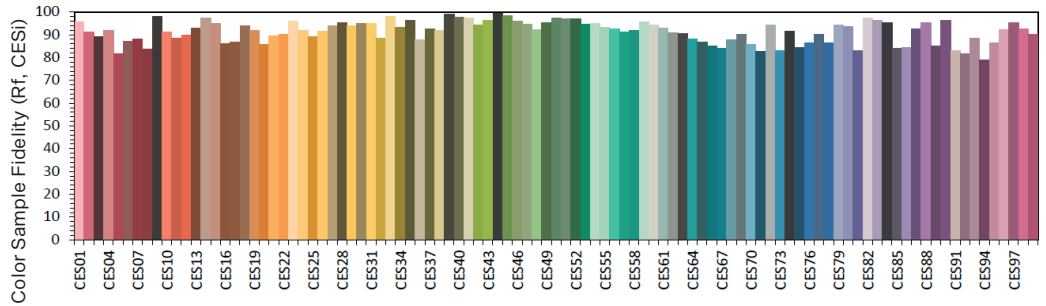
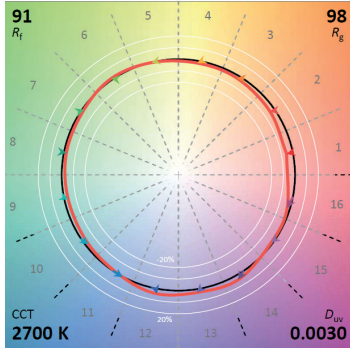

**RGBNW VERSION**

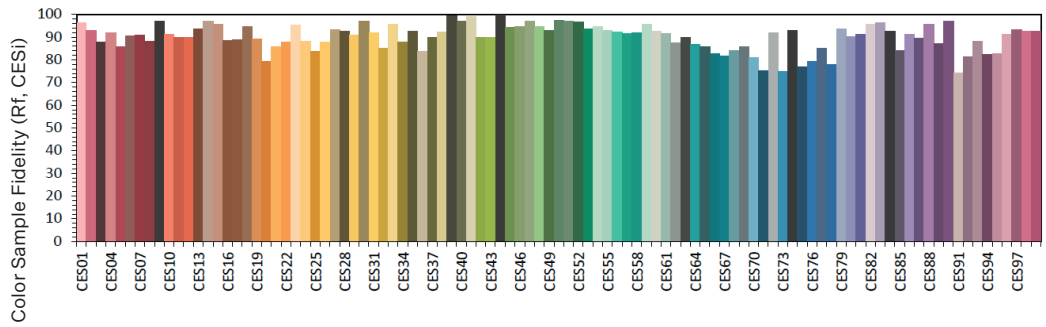
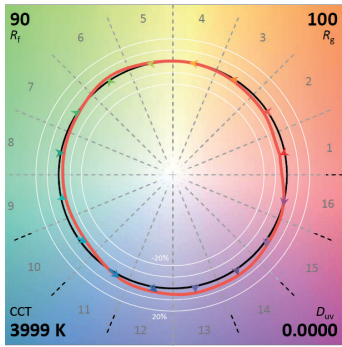

**PHOTOMETRIC OVERVIEW**

Lumen Output (lm)

	RGBWW (2700 K)	RGBNW (4000 K)	PW (2700 K)	PW (4000 K)	TW (2700 - 4000 K)	TD (3200 K)
<b>20° with Louver</b>	1 109	1 488	1 526	1 911	1 109 - 1 488	1 500
<b>20° without Louver</b>	1 705	2 289	2 347	2 940	1 705 - 2 289	2 307
<b>40°</b>	2 253	3 024	3 101	3 884	2 253 - 3 024	3 048
<b>60°</b>	2 413	3 239	3 321	4 160	2 413 - 3 239	3 265
<b>80°</b>	2 343	3 145	3 225	4 039	2 343 - 3 145	3 170

**UNIFIED GLARE RATING (UGR)**

<b>20° with Louver</b>	<7 UGR
<b>20° without Louver</b>	<17 UGR
<b>40°</b>	< 21 UGR
<b>60°</b>	< 22 UGR
<b>80°</b>	< 25 UGR

PHOTOMETRIC DATA

Ambiane HP111 RGBNW 20dg with Ring Louver

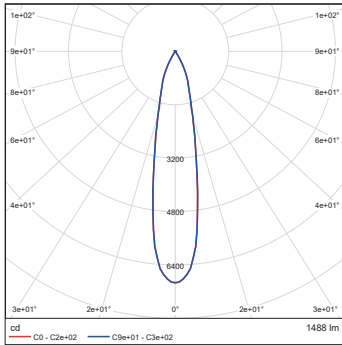

Ambiane HP111 RGBNW 20dg without Ring Louver

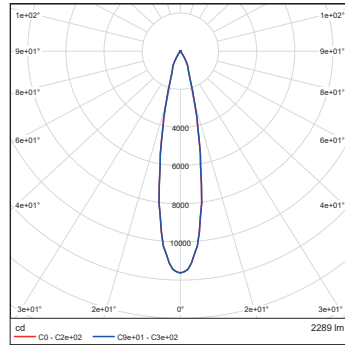

Ambiane HP111 RGBNW 40dg

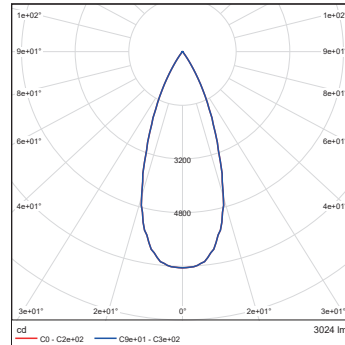

Ambiane HP111 RGBNW 60dg

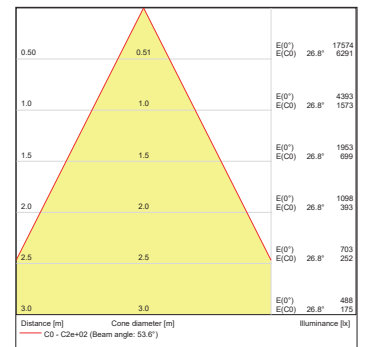
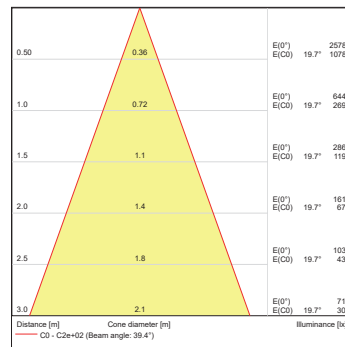
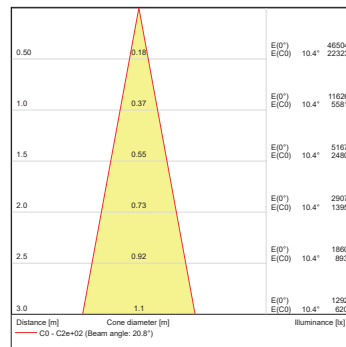
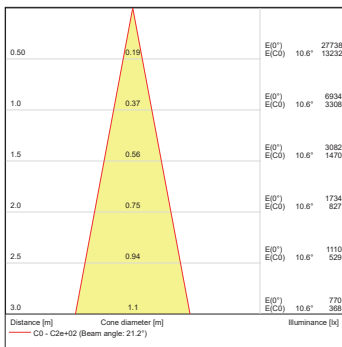
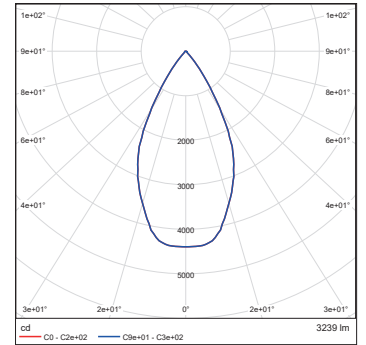

Ambiane HP111 RGBNW 80dg

