

AMBIANE® SP16 RECESSED

The smallest luminaire of Ambiane range with only 108 mm in diameter offers efficient, powerful and high-quality solution for lower ceiling recessed applications. Highly efficient LED module with CRI 90+, no UV or IR emissions, CCT and green correction settings is perfect for museums, art galleries, theaters, concert halls and other most demanding installations. Sharing the same LED chip-set with other Ambiane fixtures it complements the range and gives lighting designers even more options for various interior lighting installations.



KEY FEATURES

Lumen output & Light source

Available in wide range of colour configurations (RGBW, PW, TW, TD), the Ambiane SP16 Recessed utilises highly efficient LED modules with CRI 90+. The fixture offers two different beam spreads of 30° and 60°.

Control

Using DALI or USITT DMX512 control protocols, with RDM support, Ambiane SP16 Recessed can be remotely controlled and managed. Ambiane SP16 Recessed also offers intelligent power balancing.

Installation

With compact dimensions, Ambiane SP16 Recessed is suitable for lower ceiling applications and to complement our more powerful luminaires of Ambiane range. Ambiane SP16 Recessed is convection cooled for silent operation without fans.

COLOURS



COLOUR TEMPERATURE

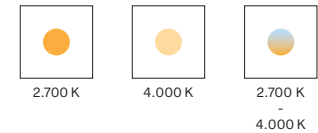

CONTROL & PROTOCOLS



OPTIC OPTIONS

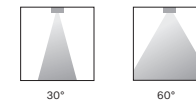

STANDARD & SPECIFICATION

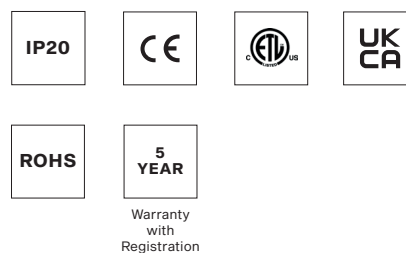

TRIM FINISH OPTIONS

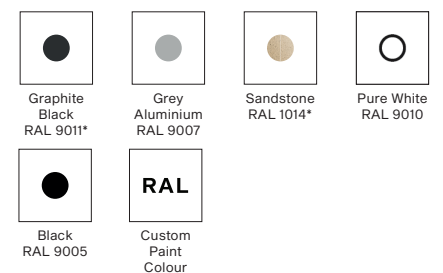

SPECIFICATION

ELECTRICAL	Input Voltage	48 V DC			
	Input Voltage range	44-50 V DC			
	Max. Power Consumption	10 W			
OPTICAL	Light Source	High Power LED module			
	Colour Variants	RGBW (W 2700 K or 4000 K)	Pure White	Tunable White	Tungsten Dim
	Colour Temperature of White	PW 2700 K or 4000 K TW 2700-4000 K TD 3200 K			
	CRI	90+			
	Beam Angle	30° 60°			
	Lumen Output Delivered	481 lm (RGBW at 30° White LEDs only)			
		518 lm (RGBW at 60° White LEDs only)			
Projected Lumen Maintenance	L90B10 >90.000 hrs, Ta = 25°C / 77°F				
CONTROL	Interface Protocol	USITT DMX512, RDM, DALI 2, 0-10 V			
	DALI 2 Device Type	DT 8			
	Control System	ArcControl Range or any Third Party Controller			
	DMX Modes	5 (for RGBW version)			
	DMX Channels	4, 3, 12, 3, 6			
	Settings / Addressing	DIP Switch, RDM			
	Power Supply	Ambiane Power AP (up to 4x Ambiane SP16)			
Ambiane Power Rack (up to 4x Ambiane SP16 per output)					
PHYSICAL	Diameter x Height	Ambiane SP16 Recessed 30° / 60° - ø108 x 110 / 100 mm (ø4.2 x 4.3 / 3.9 in.)			
		Ambiane SP16 Recessed 30° / 60° with Yoke - ø108 x 138 / 128 mm (ø4.2 x 5.4 / 5 in.)			
		Ambiane SP16 Recessed 30° / 60° Trimless - ø150 x 123 / 113 mm (ø5.9 x 4.8 / 4.5 in.)			
		Ambiane SP16 Recessed 30° / 60° Trimless US - ø150 x 147 / 137 mm (ø5.9 x 5.8 / 5.4 in.)			
	Weight	0.49 kg 1.08 lbs			
	Housing	Die-Cast Aluminium Body			
	Trim Finish Options	Standard Color	Graphite Black RAL 9011 Grey Aluminium RAL 9007 Pure White RAL 9010 Sandstone RAL 1014 Black RAL 9005		
		Cost Option	Custom RAL		
	Cables / Connections	Terminal block (Power In, DMX In/Out, DALI In/Out, Secondary Power Input)			
	Mounting Method	Recessed, Via Spring Clips. Cut-Out Diameter: 90 mm / 3.5 in			
		Recessed, Via Yoke (Spring Clips not included)			
	Protection Factor	Recessed, Trimless, Bayonet mounting method Cut-Out Diameter: 110 mm / 4.3 in			
		IP20 / Dry location only			
	Cooling System	Convection			
Operating Ambient Temperature	-20 °C / +40 °C (-4 °F / +104 °F) (TBC)				
Max. Operating Temperature	+75°C (167°F) (TBC)				
CERTIFICATION	Listings	ETL / cETL, RoHS, CE, UKCA			
ACCESSORIES	Included Items				
	Control Unit for Ambiane SP16				
	Not Included Items				
	Ambiane Power Rack (CE/US)				
Ambiane Power AP					
Glass suction cup (for easy installation of the trimless version)					

SPECIFICATION SHEET
AMBIANE® SP16 RECESSED

DIMENSIONS

Ambiane SP16 Recessed - standard

30° H = 110 mm [4 5/16" inch]
 60° H = 100 mm [3 15/16" inch]

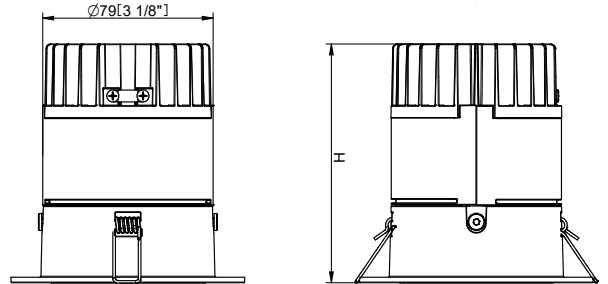
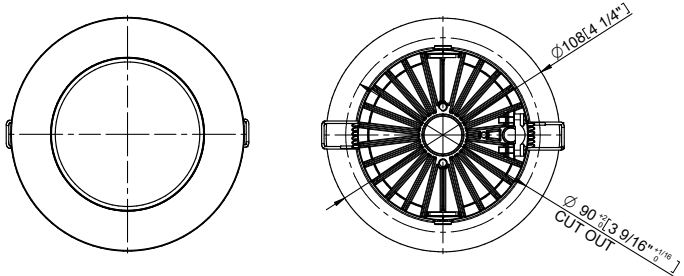

Ambiane SP16 Recessed - version with Yoke

30° H = 110 mm [4 5/16" inch]
 60° H = 100 mm [3 15/16" inch]

30° H2 = 138 mm [5 5/16" inch]
 60° H2 = 128 mm [4 15/16" inch]

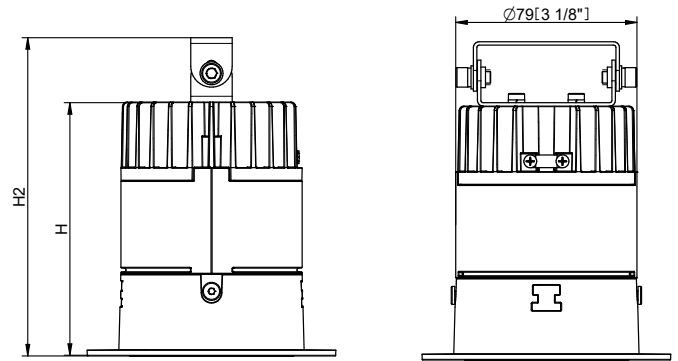
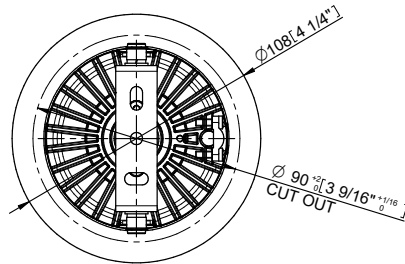

Ambiane SP16 w/Control Unit

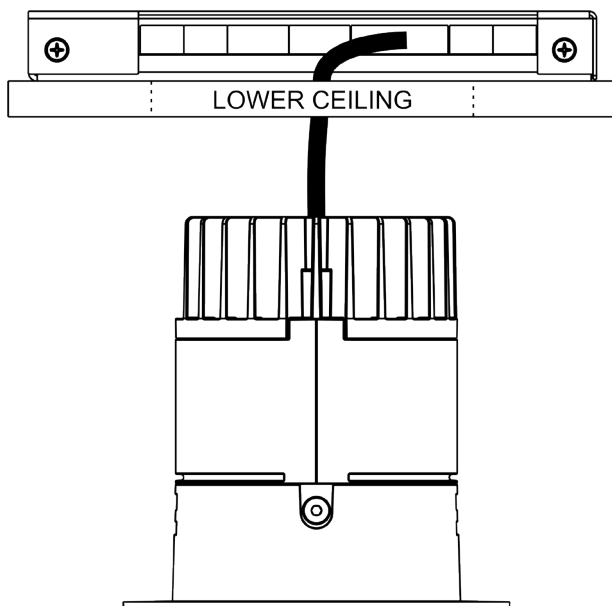

Control Unit dimensions

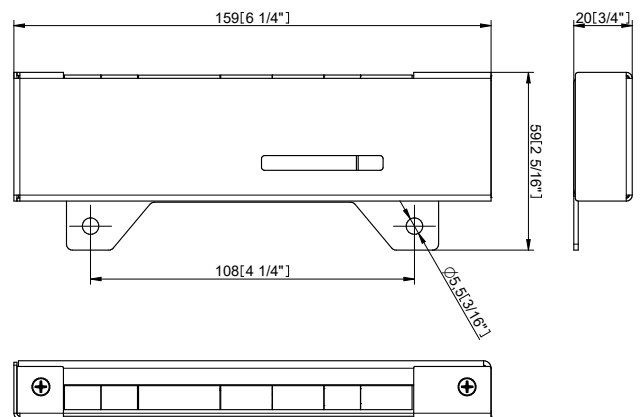

Ambiane SP16 Recessed Trimless

30° H = 123 mm [4 8/8" inch]
 60° H = 113 mm [4 7/16" inch]

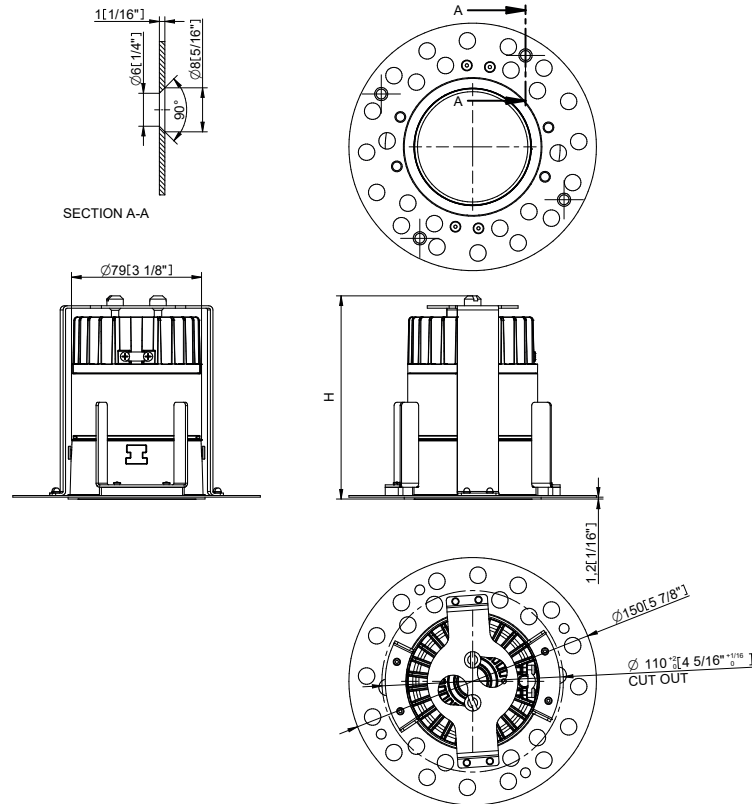

Ambiane SP16 Recessed Trimless US

30° H = 147 mm [5 13/16" inch]
 60° H = 137 mm [5 3/8" inch]

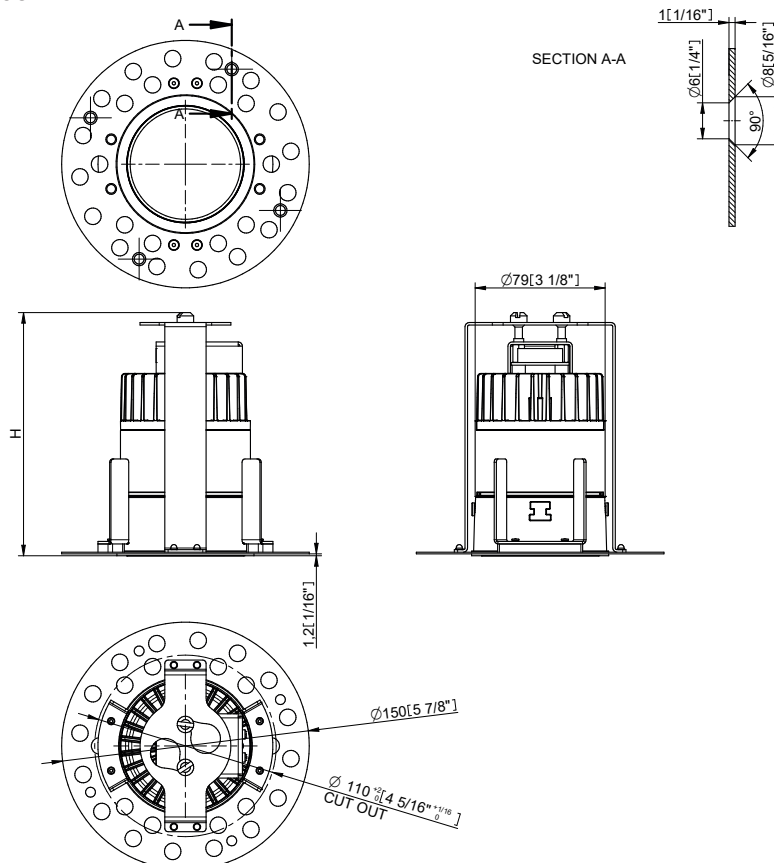

DIAMETER OF CONDUCTORS

Recommended diameters of conductors with respect to distance between Fixture and Power supply (per 4pcs of Ambaine SP16)

Distance / Cable length	100 m
Diameters of conductors	1 mm ²

PHOTOMETRIC DATA

Ambiane SP16 Recessed
 RGBW 30dg White LEDs only

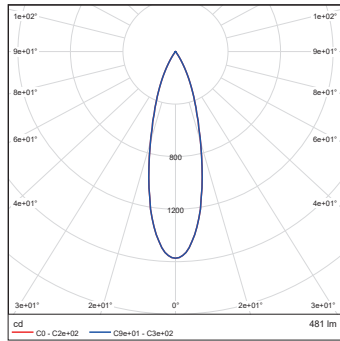

Ambiane SP16 Recessed
 RGBW 60dg White LEDs

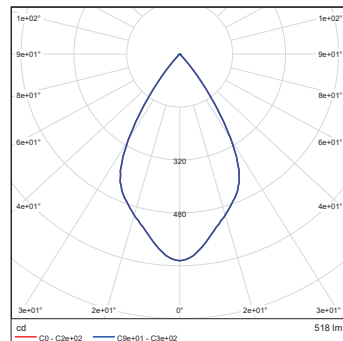

PHOTOMETRIC OVERVIEW

	Lumen Output (lm)	
	30°	60°
RGBW (4000 K) WHITE LEDS ONLY	481	518

