

# EMINERE® REMOTE 1 / 2 / 3 / 4

The newest member of the Eminere product range, Eminere Remote extends our series of linear architectural fixtures into further application possibilities using only low voltage for higher safety restrictions. Available in four sizes, ranging from 1 to 4 feet, Eminere Remote follows the identical optical and performance features of our other established and proven Eminere fixtures. Design-wise, Eminere Remote brings all of today's technology into an elegant and slim body, but is still very robust with an IP67 rating to withstand the harshest environments.



## KEY FEATURES

### Optic & Control

Output up to 1.147 lm (RGBW) or 1.652 lm (PW) per one foot of Eminere. With a wide range of optics for limitless fixture applications, Eminere Remote can also be operated in pixel (12 LEDs) or fixture modes, and its low-input voltages allow the luminaire to be used in applications with higher safety restrictions.

### Compact design

At only 39 mm of total height, Eminere Remote is the thinnest lighting solution in our Eminere series and has been designed as a compact and slim LED luminaire suitable for any low-profile application.

### Durability

Thanks to its tempered glass and high-pressure, extruded aluminum housing, Eminere Remote is IK06 and IP67 certified. For more extreme and marine applications, a harsh environment finish option is also available.

## COLOURS

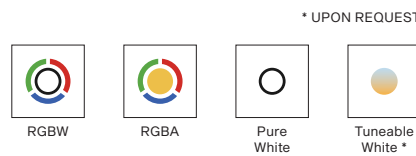

## CONTROL & PROTOCOLS

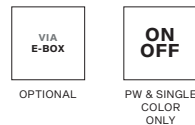

## STANDARD & SPECIFICATION

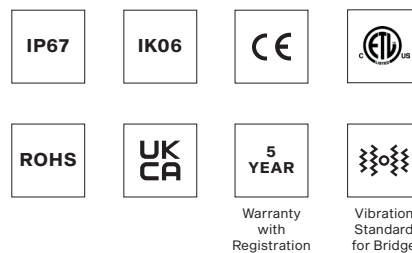

## FINISH OPTIONS

\* CLOSEST RAL TONE  
\* HE = Harsh Environment



## COLOUR TEMPERATURE

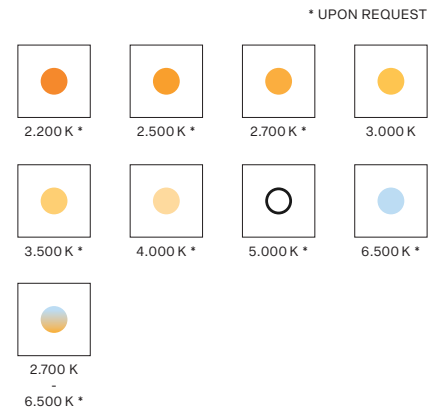

## OPTIC OPTIONS

### SYMMETRICAL

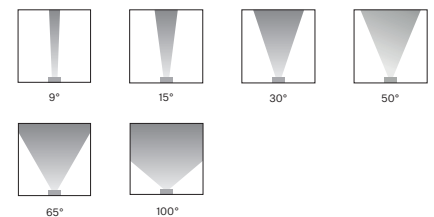

### BI-SYMMETRICAL

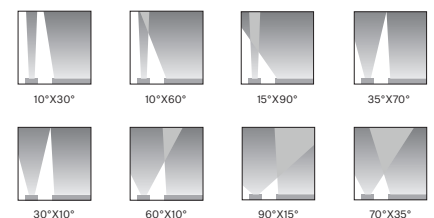

### ASYMMETRICAL



**SPECIFICATION**

<b>ELECTRICAL</b>	Input Voltage	48 V		
	Typical Power Consumption	<b>Eminere Remote 1:</b> 20 W	<b>Eminere Remote 2:</b> 40 W	
		<b>Eminere Remote 3:</b> 60 W	<b>Eminere Remote 4:</b> 80 W	
<b>OPTICAL</b>	Light Source	12, 24, 36, 48 x High Power Single Chip LEDs		
	Colour Variants	RGBW (W - 6.500 K)	RGBA	PW (W - 3.000 K)
		Variants On Request: (TW (2700 - 6500 K)   2.200 K   2.500 K   2.700 K   3.500 K   4.000 K   5.000 K   6.500 K)		
	Beam Angle	Symmetrical:	9°   15°   30°   50°   65°   100°	
		Bi-symmetrical:	10° x 30°   30° x 10°   10° x 60°   60° x 10°   35° x 70°   70° x 35° 15° x 90°   90° x 15°	
		Asymmetrical:	Wallwasher   Wide Wallwasher	
Lumen Output Delivered	<b>Eminere Remote 1:</b> 1.147 lm, RGBW @ 9°	<b>Eminere Remote 2:</b> 2.294 lm, RGBW @ 9°		
	<b>Eminere Remote 3:</b> 3.441 lm, RGBW @ 9°	<b>Eminere Remote 4:</b> 4.588 lm, RGBW @ 9°		
Projected Lumen Maintenance	L90B10 >90.000 hrs, Ta = 25°C / 77°F			
<b>CONTROL</b>	Interface Protocol	Via E-Box Remote range   ON/OFF (PW & single color only)		
	E-Box Remote Control Protocols	USITT DMX512, RDM, ArtNet, MA Net, MA Net2, sACN, Kling-Net		
	Operating Modes	Pixel (12 LEDs/300mm) or Fixture mode		
	Setting / Addressing	Via Two Row LCD Display with Control Buttons on E-Box Remote or RDM communicator		
	Power Supply	Via E-Box Remote range		
	Connectivity	E-box Remote	16 pcs of Eminere Remote 1 (50m cable - total length) via 1 Output, 20 pcs in total for both Outputs (25m cable - total length)	
		E-box Remote Basic		
Width x Height x Length	<b>Eminere Remote 1</b>	113 x 39 x 329 mm (4.45 x 1.54 x 12.95 in.)		
	<b>Eminere Remote 2</b>	113 x 39 x 629 mm (4.45 x 1.54 x 24.76 in.)		
	<b>Eminere Remote 3</b>	113 x 39 x 929 mm (4.45 x 1.54 x 36.57 in.)		
	<b>Eminere Remote 4</b>	113 x 39 x 1229 mm (4.45 x 1.54 x 48.39 in.)		
	Weight	2 kg   4.41 lbs	3.1 kg   6.83 lbs	4.1 kg   9.04 lbs
Housing	High Pressure Extruded Aluminium Body   End Caps - Die-Cast Aluminium   Tempered Glass			
<b>PHYSICAL</b>	Finish Options	Standard Colour	Graphite Black RAL 9011   Grey Aluminium RAL 9007 Pure White RAL 9010   Sandstone RAL 1014	
		Standard Colour Harsh Environment	Graphite Black RAL 9011   Grey Aluminium RAL 9007 Pure White RAL 9010   Sandstone RAL 1014	
		Cost Option	Custom RAL	
Cables / Connections	Integrated Junction Box			
Mounting Method	Surface Mount With Different Type of Brackets			
Adjustability	+30°			
Protection Factor	IP67 / Suitable For Wet Locations			
IK Rating	IK06			
Cooling System	Convection			
Operating Ambient Temperature	-20 °C / +40 °C (-4 °F / +104 °F)			
Operating Temperature	+67 °C @ Ambient +40 °C (+153 °F @ Ambient +104 °F)			
<b>CERTIFICATION</b>	Listings	ETL / cETL, CE, RoHS, UKCA		
<b>ACCESSORIES</b>	<b>Not Included Items</b>			
	Mounting Brackets	Cabel for Eminere Remote - bare end (custom length)		
		Mounting Brackets 100   200   300 mm   custom length		
		Wall Mount Brackets for Eminere Remote		
		Re-enterable Electrical Insulating Resin		
Shields	Shield For Eminere Remote (with or without Side Covers) 1   2   3   4			

DIMENSIONS

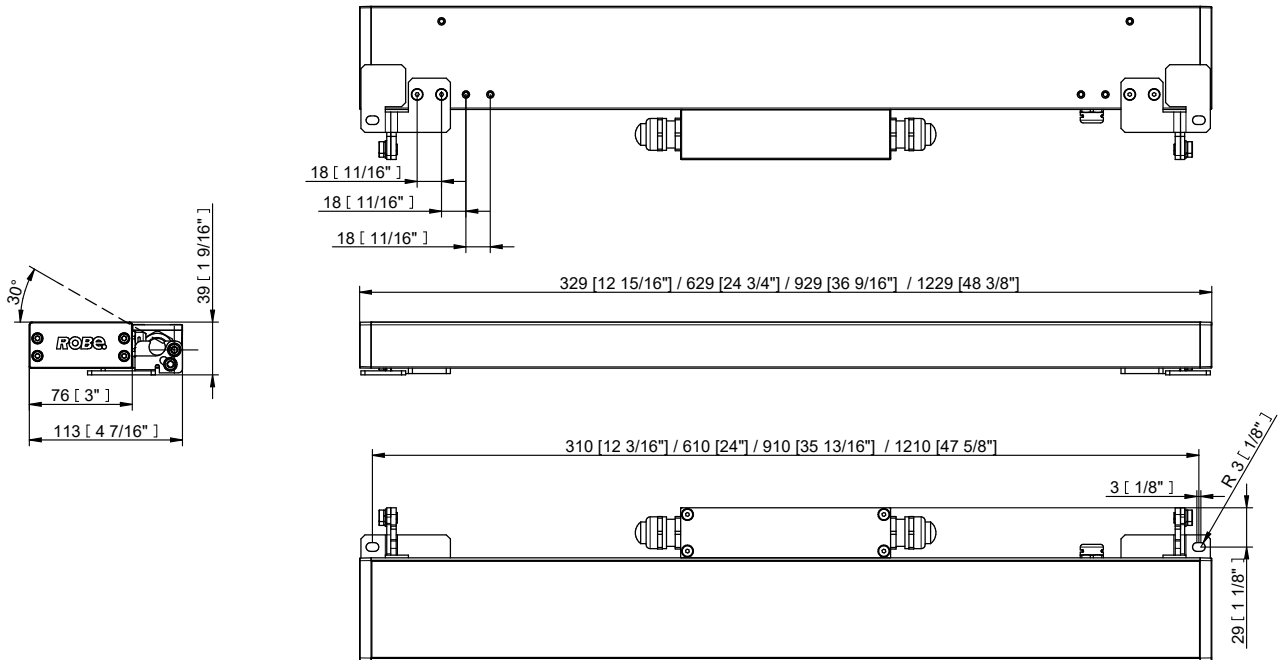

PROJECTED AREA

	Front (rear) - m <sup>2</sup>	Front (rear) ft <sup>2</sup>	Side - m <sup>2</sup>	Side - ft <sup>2</sup>	Top - m <sup>2</sup>	Top - ft <sup>2</sup>
<b>Eminere Remote 1</b>   with Shield	<b>0,012</b>   0,029	<b>0,129</b>   0,312	<b>0,004</b>   -	<b>0,043</b>   -	<b>0,035</b>   0,036	<b>0,377</b>   0,387
<b>Eminere Remote 2</b>   with Shield	<b>0,022</b>   0,055	<b>0,237</b>   0,592	<b>0,004</b>   -	<b>0,043</b>   -	<b>0,058</b>   0,059	<b>0,624</b>   0,635
<b>Eminere Remote 3</b>   with Shield	<b>0,032</b>   0,080	<b>0,344</b>   0,861	<b>0,004</b>   -	<b>0,043</b>   -	<b>0,081</b>   0,083	<b>0,871</b>   0,893
<b>Eminere Remote 4</b>   with Shield	<b>0,042</b>   0,106	<b>0,452</b>   1,140	<b>0,004</b>   -	<b>0,043</b>   -	<b>0,104</b>   0,106	<b>1,119</b>   1,140

ACCESSORIES

Shield for Eminere Remote

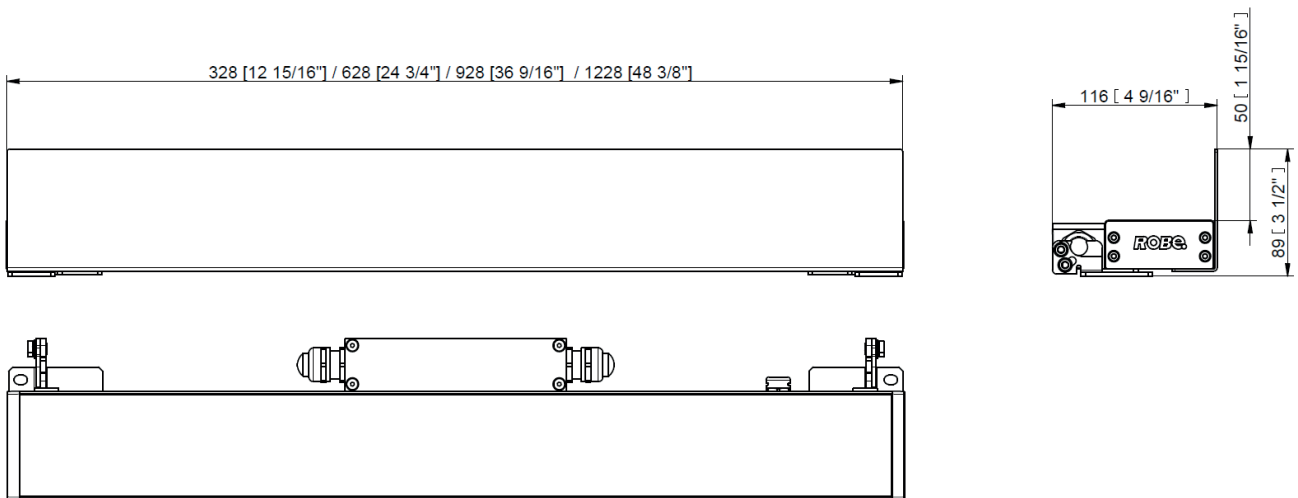

Mounting brackets

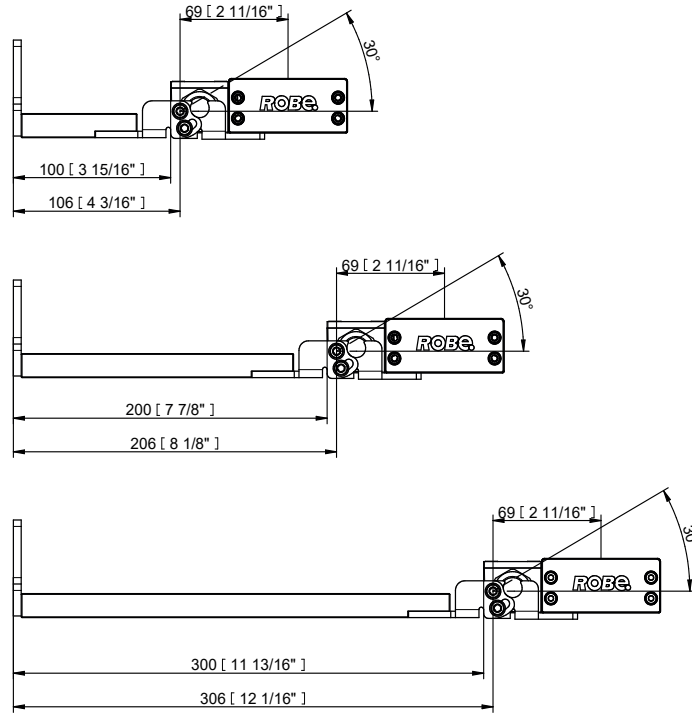

Wall Mount Brackets for Eminere Remote

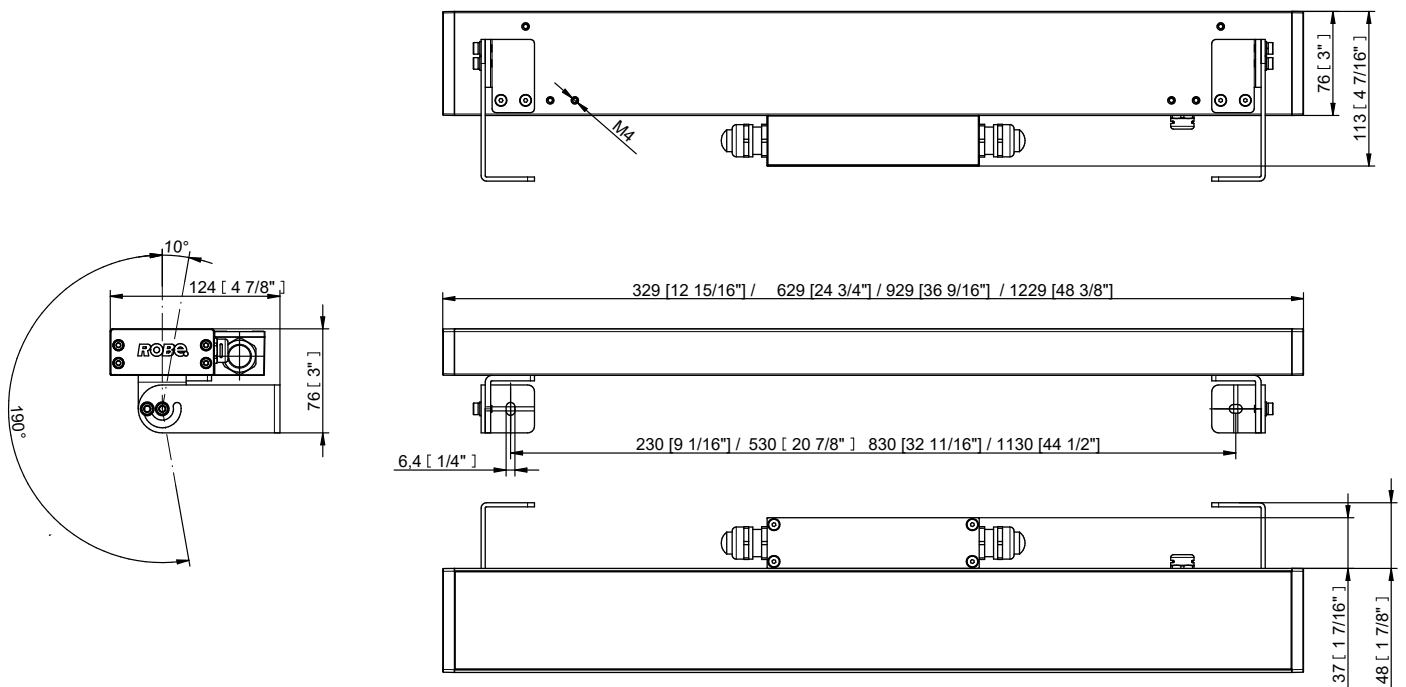

Barndoor without side covers

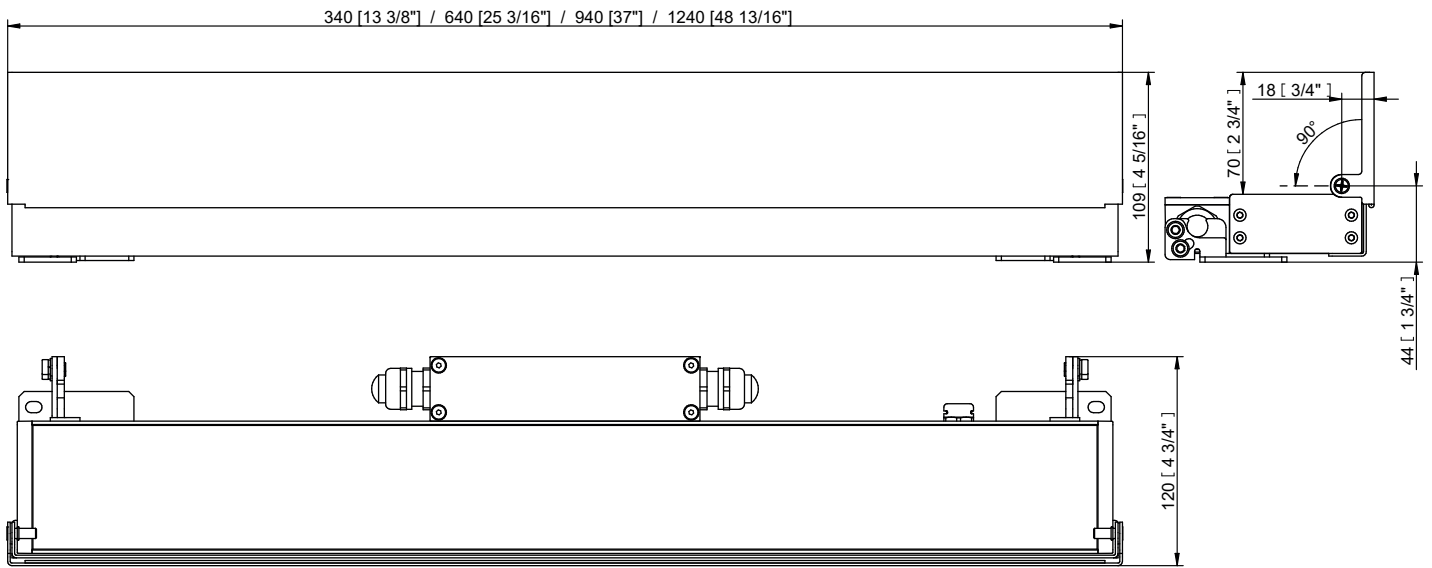

Barndoor with side covers

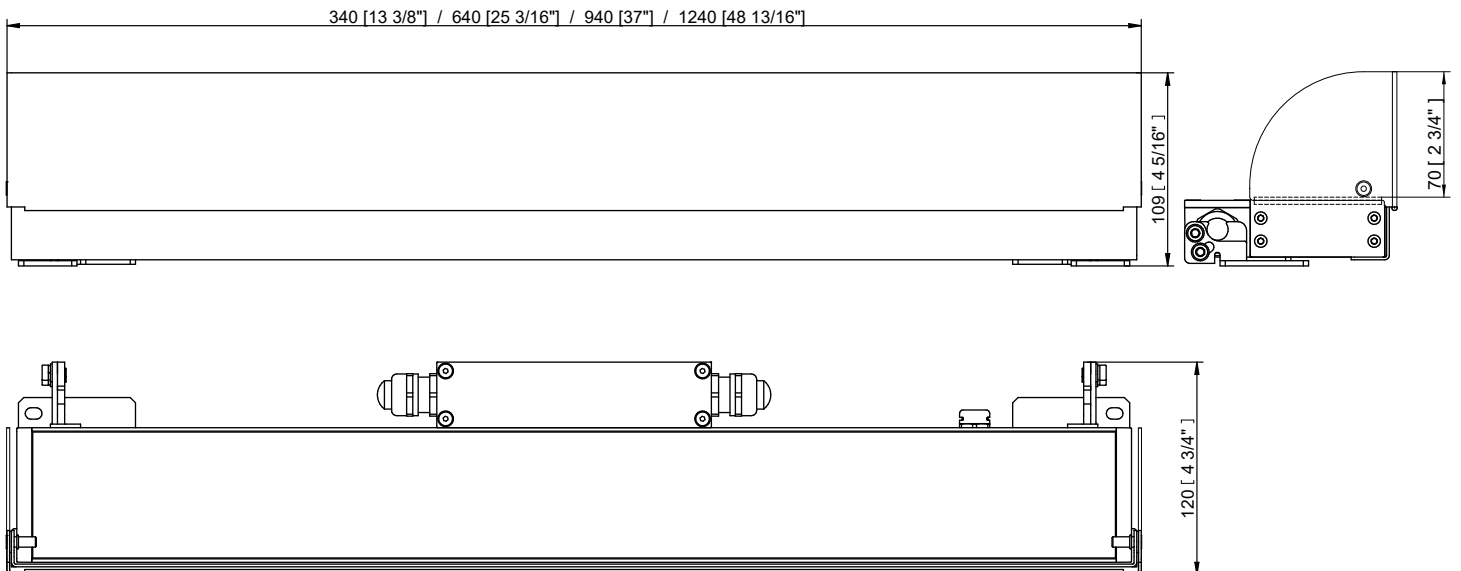

**BI-SYMMETRICAL BEAM ANGLES**

Bi-symmetrical: 10°x30°, 10°x60°, 35°x70°, 15°x90°

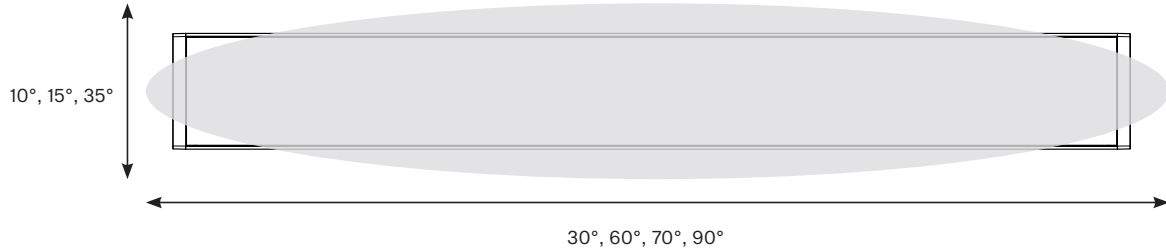

Bi-symmetrical: 30°x10°, 60°x10°, 70°x35°, 90°x15°

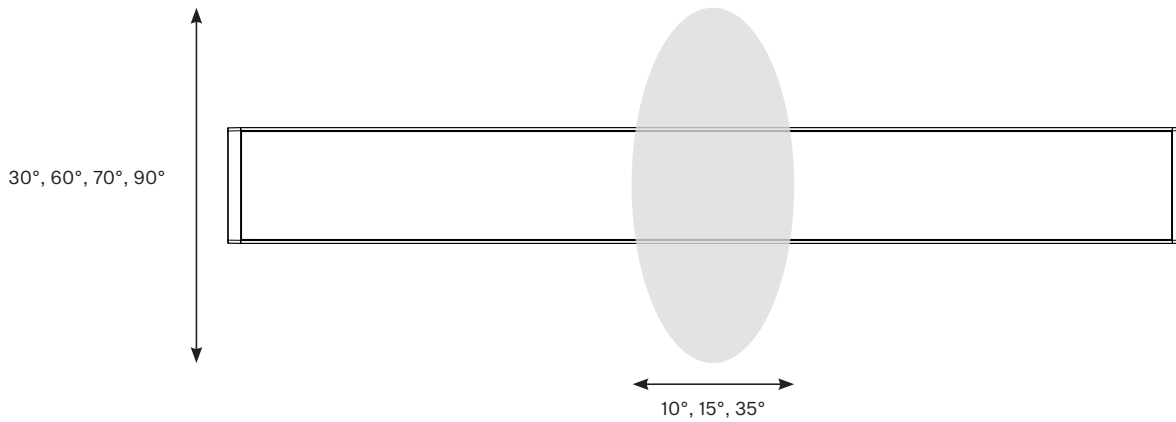

**CONNECTION**

The table states max. number of Eminere Remote modules connected to the E-box Remote or Remote Basic.

Cable length (m)	Max. number of Emineres Remote connected to the E-Box Remote or Remote Basic			
	EMINERE REMOTE 1	EMINERE REMOTE 2	EMINERE REMOTE 3	EMINERE REMOTE 4
25	20	10	6	5
50	16	8	5	4
75	13	6	4	3
100	10	5	3	2

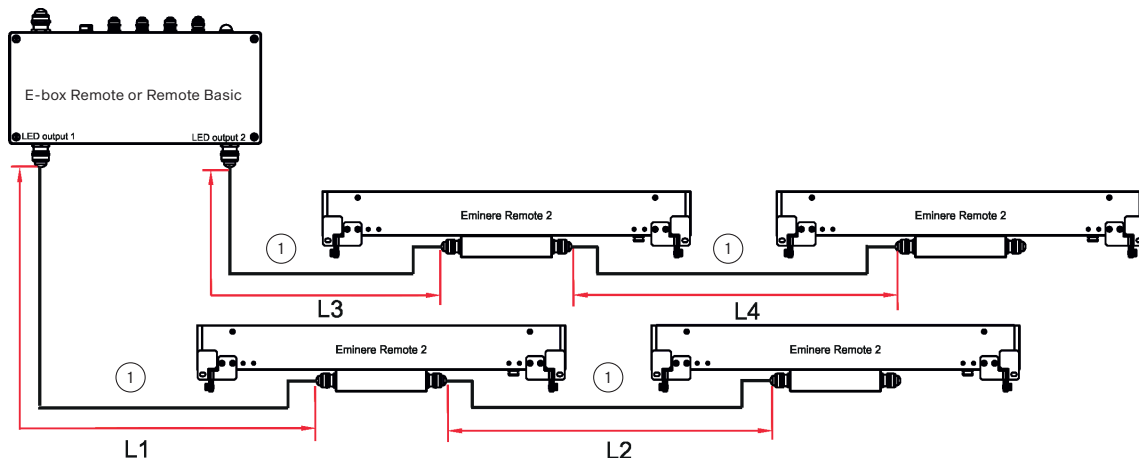

1) SJTW 5x 14AWG (13053336), black or On request Cable SJTW 5x 14AWG (13053697) white

\* Cable length is a total cable length between E-box Remote (or Remote Basic) and last connected Eminere Remote. Example: Total cable length=L1+L2+L3+L4

COLOUR MIXING PRINTS

**STAND ALONE** Specially designed glass printing to achieve optimal colour mixing and intensity distribution.

**HEAD2HEAD** Fixtures without special end glass print installed right next to each other create absolutely perfect colour and intensity overlap.

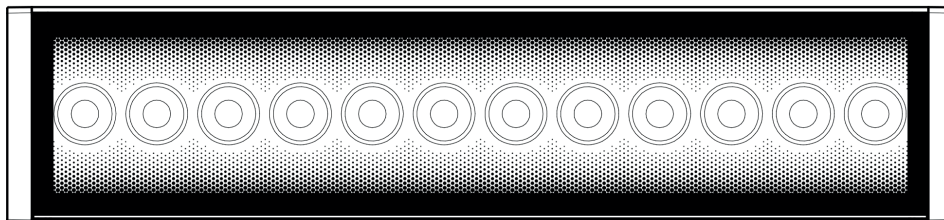

HEAD2HEAD

SYMMETRICAL

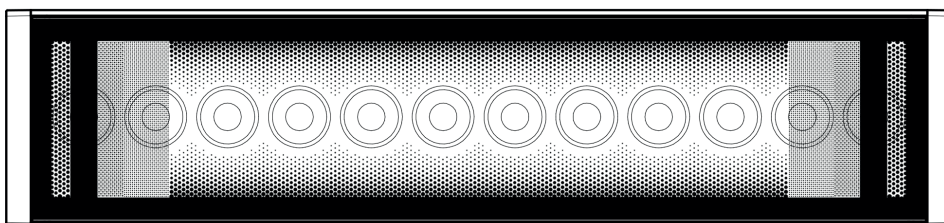

STAND ALONE

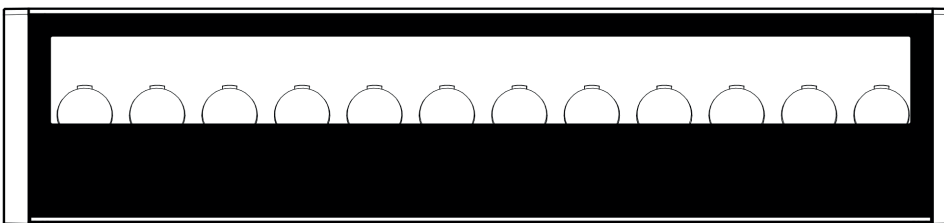

HEAD2HEAD

WALLWASHER

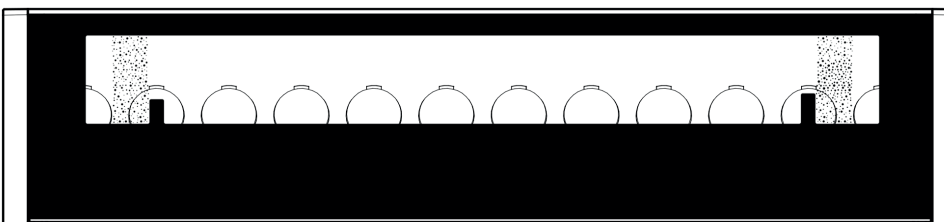

STAND ALONE

**Note: Applies for RGBW, RGBA versions. Pure white and Tunable white versions are always without the end print (no matter on their position to other fixture).**

### E-BOX REMOTE SPECIFICATION

<b>ELECTRICAL</b>	Input Voltage	120 – 277 V AC 50/60 Hz
	Typical Power Consumption	520 W
<b>CONTROL</b>	Wireless DMX (Option)	Lumen Radio CRMX Technology
	Interface Protocol	USITT DMX512+RDM, ArtNet, MA Net, MA Net2, sACN, Kling-Net
	Operating Modes	Fixture Mode, Pixel Mode, Output Mode
	Display	Via Two Row LCD Display with Control Buttons or RDM communicator
	Control System	E-box With Self Addressing Feature or Custom Setting Via LCD Display/RDM
	Power Supply	Integrated in E-box Remote
	Connectivity	16 pcs of Eminere Remote 1 (50m cable - total length) via 1 Output, 20 pcs in total for both Outputs (25m cable - total length)
	<b>PHYSICAL</b>	Length x Width x Height   Weight
Number of LED Output zones		2
Max. Load Per Output		16 pcs of Eminere Remote 1 (50m cable) via 1 Output
Cable Length per E-Box		Max. 25 m (@ 20 pcs)   Max. 50 m (@ 16 pcs)   Max. 75 m (@ 13 pcs)   Max. 100 m (@ 10 pcs)
Housing		Die-Cast Aluminium Case
Finish Options		Standard Colour - Graphite Black (RAL 9011)   Silver (RAL 9006)
		Cost Option - Custom RAL   Harsh Environment (RAL 9016, RAL 9011)
Cables / Connections		Cable Grommet (stainless steel)
Mounting Method		Surface Mount, 4 Mounting Holes
Protection Factor		IP65 / Suitable For Wet Locations
IK Rating		IK10
Cooling System		Convection
Operating Ambient Temperature		-20 °C / +40 °C (-4 °F / +104 °F)
<b>CERTIFICATION</b>	Listings	ETL / cETL, CE, RoHS, UKCA

### E-BOX REMOTE BASIC SPECIFICATION

<b>ELECTRICAL</b>	Input Voltage	120 - 277 V AC 50/60 Hz
	Typical Power Consumption	520 W
<b>CONTROL</b>	Power supply	Integrated
	Connectivity	16 pcs of Eminere Remote 1 (50m cable - total length) via 1 Output, 20 pcs in total for both Outputs (25m cable - total length)
<b>PHYSICAL</b>	Length x Width x Height   Weight	360 x 210 x 91 mm (14.17 x 8.27 x 3.58 in.)   5 kg / 11.02 lbs
	Number of LED Output zones	2
	Max. Load Per Output	16 pcs of Eminere Remote 1 (50 m cable) via 1 Output
	Cable Length per E-Box	Max. 25 m (@ 20 pcs)   Max. 50 m (@ 16 pcs)   Max. 75 m (@ 13 pcs)   Max. 100 m (@ 10 pcs)
	Housing	Die-Cast Aluminium Case
	Finish Options	Standard Colour - Graphite Black (RAL 9011)   Silver (RAL 9006)
		Cost Option - Custom RAL,   Harsh Environment (RAL 9016, RAL 9011)
	Cables / Connections	Cable Grommet (stainless steel)
	Mounting Method	Surface Mount, 4 Mounting Holes
	Protection Factor	IP65 / Suitable For Wet Locations
	IK Rating	IK10
	Cooling System	Convection
	Operating Ambient Temperature	-20 °C / +40 °C (-4 °F / +104 °F)
<b>CERTIFICATION</b>	Listings	ETL / cETL, CE, RoHS, UKCA



**E-BOX REMOTE DIMENSIONS**

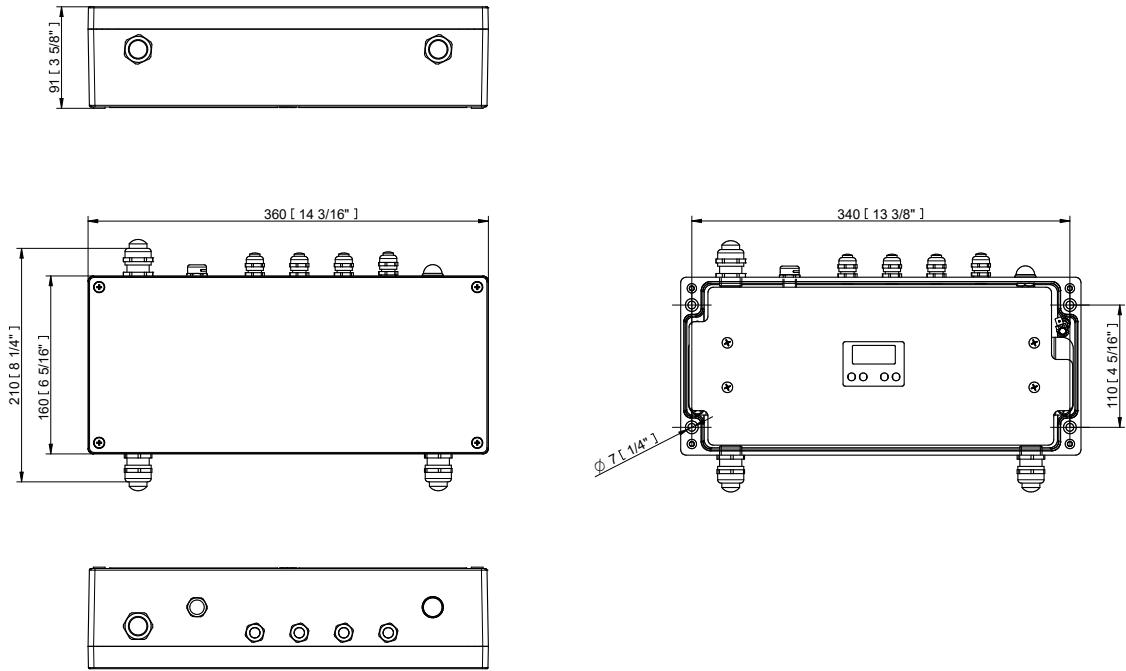

**E-BOX REMOTE BASIC DIMENSIONS**

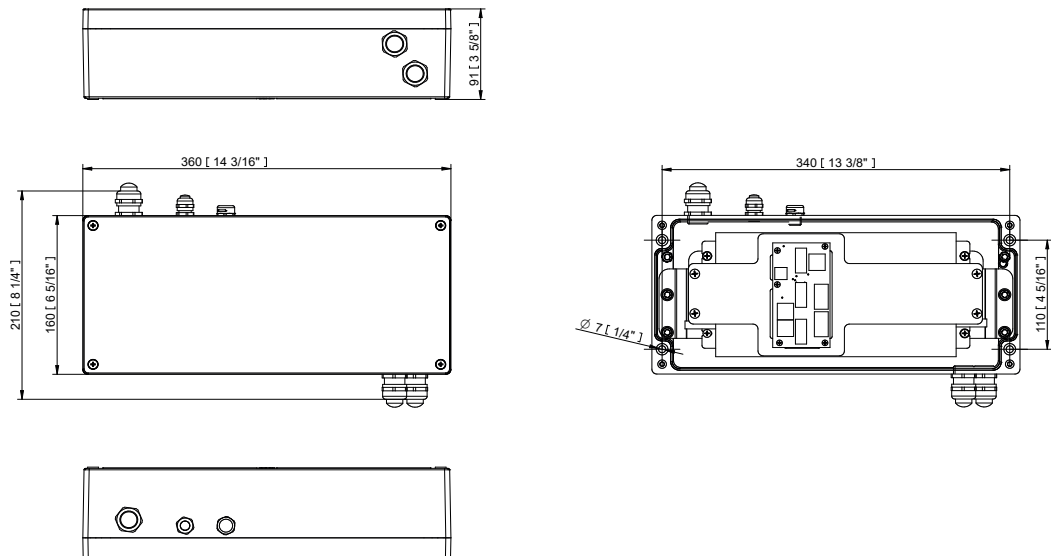

PHOTOMETRIC DATA

Eminere Remote 4 RGBCW 9dg

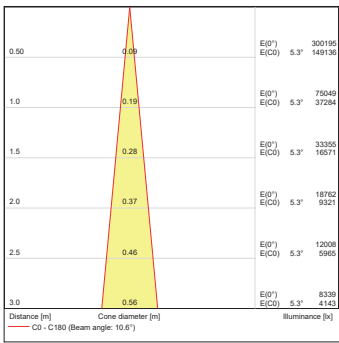
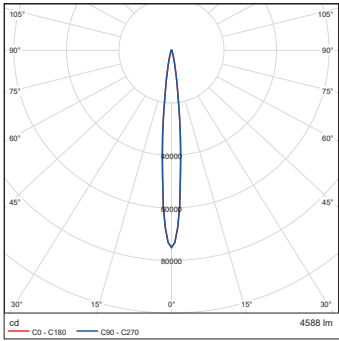

Eminere Remote 4 RGBCW 15dg

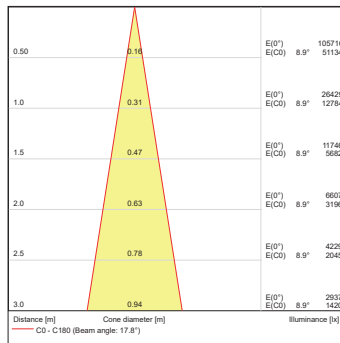
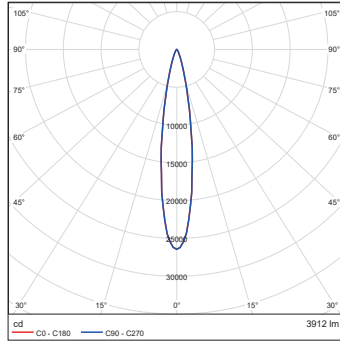

Eminere Remote 4 RGBCW 30dg

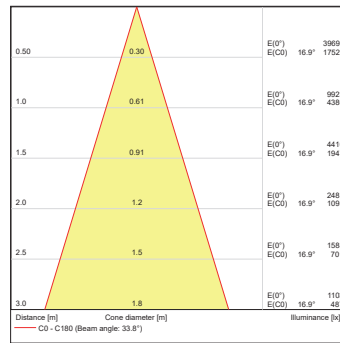
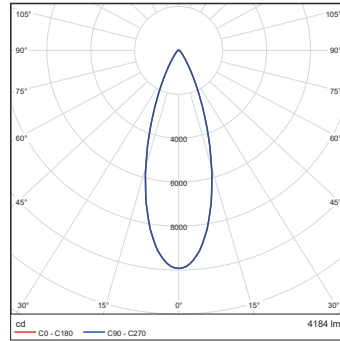

Eminere Remote 4 RGBCW 50dg

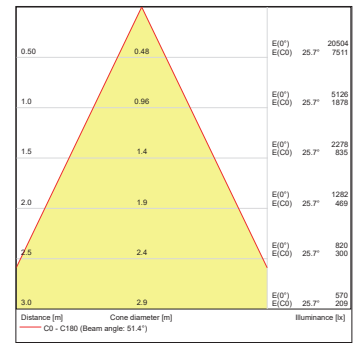
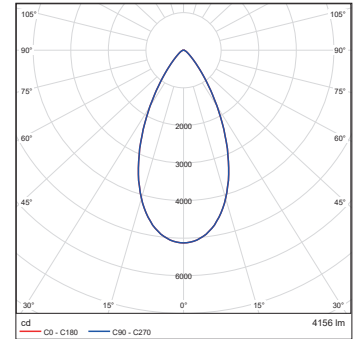

Eminere Remote 4 RGBCW 65dg

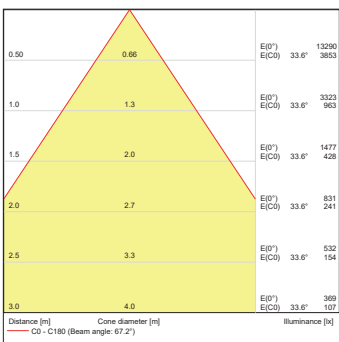
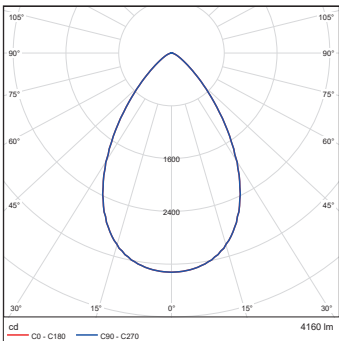

Eminere Remote 4 RGBCW 100dg

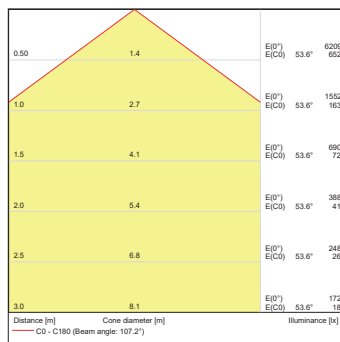
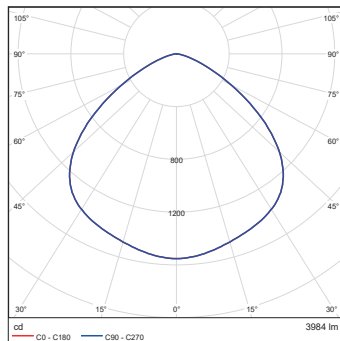

PHOTOMETRIC DATA

Eminere Remote 4 RGBCW  
10dg x 30dg

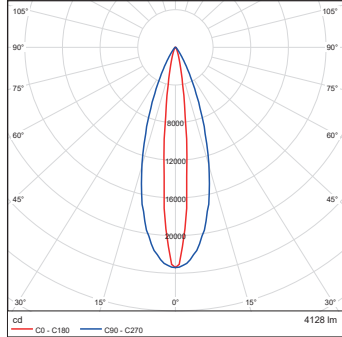

Eminere Remote 4 RGBCW  
10dg x 60 dg

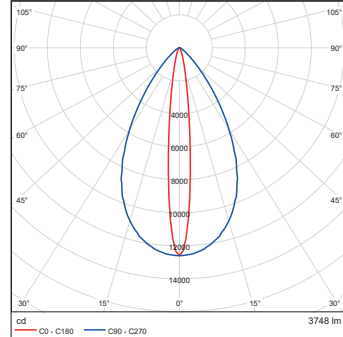

Eminere Remote 4 RGBCW  
35dg x 70dg

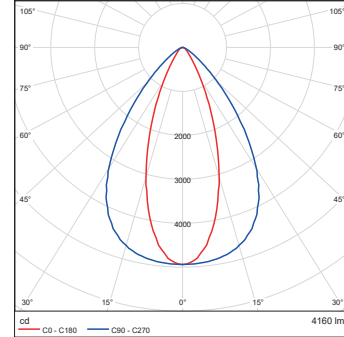

Eminere Remote 4 RGBCW  
15dg x 90dg

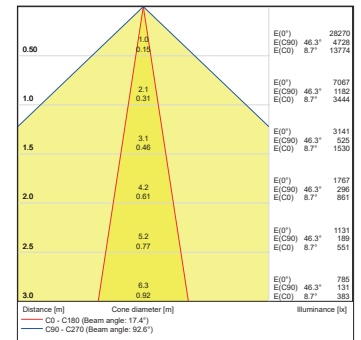
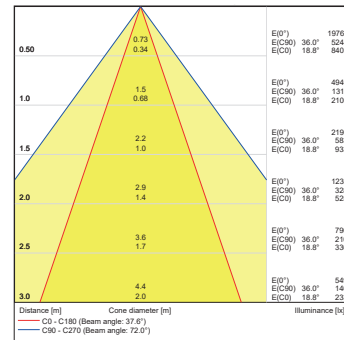
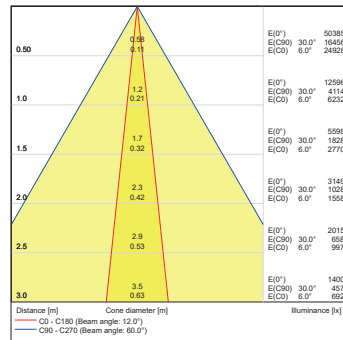
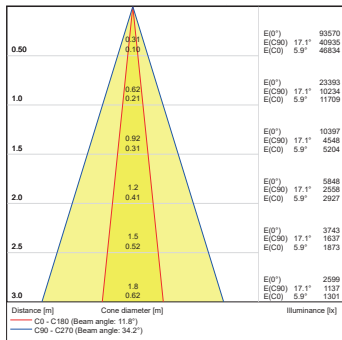
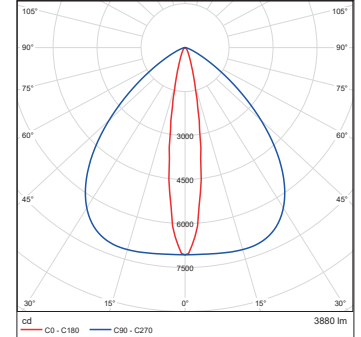

Eminere Remote 4 RGBCW Wall-  
Washer

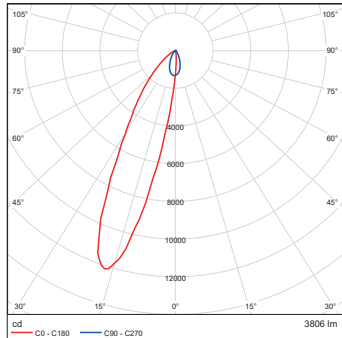

Eminere Remote 4 RGBCW Wide  
WallWasher

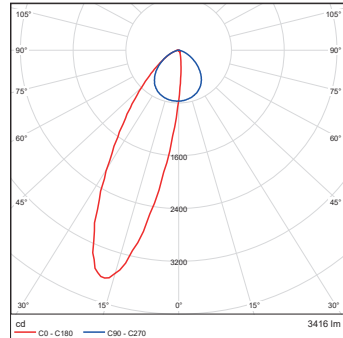

**PHOTOMETRIC OVERVIEW**

Based on RGBW version, all leds @ full

	Lumen Output (lm)			
	EMINERE 1	EMINERE 2	EMINERE 3	EMINERE 4
<b>9°</b>	1147	2294	3441	4588
<b>15°</b>	978	1956	2910	3912
<b>30°</b>	1046	2092	3138	4184
<b>50°</b>	1039	2078	3117	4156
<b>65°</b>	1040	2080	3120	4160
<b>100°</b>	996	1992	2988	3984
<b>10° x 30°</b>	1032	2064	3096	4128
<b>10° x 60°</b>	1051	1874	2811	3748
<b>15° x 90°</b>	970	1940	2934	3880
<b>35° x 70°</b>	1040	2080	3120	4160
<b>WallWasher</b>	952	1904	2856	3806
<b>Wide WallWasher</b>	854	1708	2562	3416