

CALUMMA™ XS SC

Using a four high-power, single-chip LED inside a compact, elegant, and durable housing, the smallest Calumma is a great choice for many different lighting applications. Complementing both outdoor environments and interior designs, its wide range of beam angles, LED chip white variant options and accessories make the Calumma XS SC an ideal, extra small lighting solution for any architectural design.



KEY FEATURES

Lumen output & Light source

Luminaire with four high-power, single-chip LEDs provides up to 457 lumen output (@10°, PW 3000 K). No light spills.

Design & Durability

Lightweight, compact, durable and stylish housing made of high-pressure die cast aluminium. IP67 and IK10 certification; suitable for marine applications (Harsh Environment Finish required) and traffic applications. Supported with a 5 year warranty.

Flexibility

An exceptionally compact luminaire available with a wide range of accessories, custom colour finishes, and beam angle options, Calumma XS offers the lighting designer a flexible solution for the most demanding applications.

COLOURS



CONTROL & PROTOCOLS

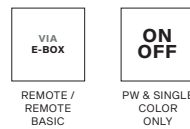

STANDARD & SPECIFICATION

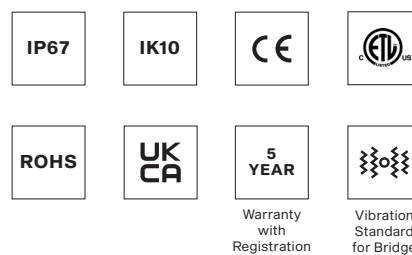

FINISH OPTIONS



COLOUR TEMPERATURE

* UPON REQUEST

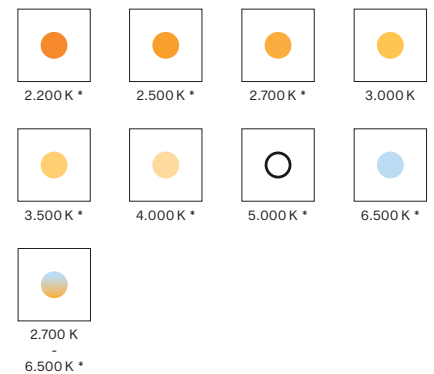

OPTIC OPTIONS

SYMMETRICAL

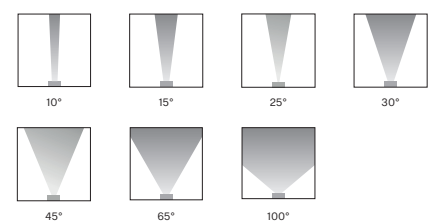

BI-SYMMETRICAL

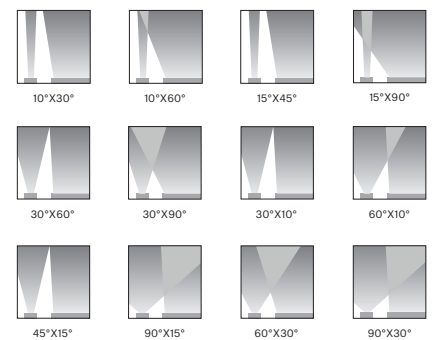

SPECIFICATION

ELECTRICAL	Typical Power Consumption	10 W	
	Input Voltage	48 V	
OPTICAL	Light Source	High Power Single Chip LEDs	
	Colour Variants	PW (W - 3000 K)	
		Other Variants On Request (TW (2700 - 6500 K), 2200 K, 2500 K, 2700 K, 3500 K, 4000 K, 5000 K, 6500 K)	
	Beam Angle	10° 15° 25° 30° 45° 65° 100°	
		10°x30° 30°x10° 10°x60° 60°x10° 15°x45° 45°x 15° 15°x90° 90°x15° 30°x60° 60°x30° 30°x90° 90°x30°	
Lumen Output Delivered	457 lm (@ 10°, PW 3000 K)		
Projected Lumen Maintenance	L90B10 >90.000 hrs, Ta = 25°C / 77°F		
CONTROL	Interface protocol	Via E-box Remote or E-box Remote Basic ON/OFF (PW & single color only)	
	E-Box Remote control protocol	USITT DMX512/RDM, ArtNet, MA Net, MA Net2, sACN, Kling-Net	
	Setting / addressing	E-box Remote, RDM communicator	
	Connectivity & Power Supply	E-Box Remote Remote Basic	
PHYSICAL	Width x Height x Depth	94 x 108 x 76 mm (3.7 x 4.2 x 2.99 in.)	
	Weight	0.6 kg 1.3 lbs	
	Housing	High Pressure Die-Cast Aluminium Body Tempered Glass	
	Finish Options	Standard Colour	Graphite Black RAL 9011 Grey Aluminium RAL 9007 Pure White RAL 9010 Sandstone RAL 1014
		Standard Colour Harsh Environment	Graphite Black RAL 9011 Grey Aluminium RAL 9007 Pure White RAL 9010 Sandstone RAL 1014
		Cost Option	Custom RAL
	Cabels / Connectivity	IN - 1 m cable with bare end - Other cable length - custom - Junction box - optional	
	Mounting Method	Yoke or Yoke for Pole Adaptor	
	Adjustability	+180° / -180°	
	Protection Factor	IP67 (IP66 Junction Box) / Suitable For Wet Locations	
IK Rating	IK10		
Cooling System	Convection		
Operating Ambient Temperature	-20 °C / +50 °C (-4 °F / +122 °F)		
CERTIFICATION	Listings	ETL / cETL, CE, RoHS, UKCA	
ACCESSORIES		Optical Demo Set for Calumma XS (for demo purposes)	
		Outdoor Foil Holder for Calumma XS (for permanent installation)	
		Optical Foil Set for Outdoor Foil Holder Calumma XS	
		Junction Box Remote (1x Output)	
		Junction Box Remote (4x Output)	
		Land Spike for Calumma XS	
		Top Hat Calumma XS	
		Half Top Hat Calumma XS	
		Tenon Adaptor for Calumma XS	
		Twin Wall Cover Calumma XS	
	Pole Adaptor (ø 102mm) (Yoke for Pole Adaptor Required)		

DIMENSIONS

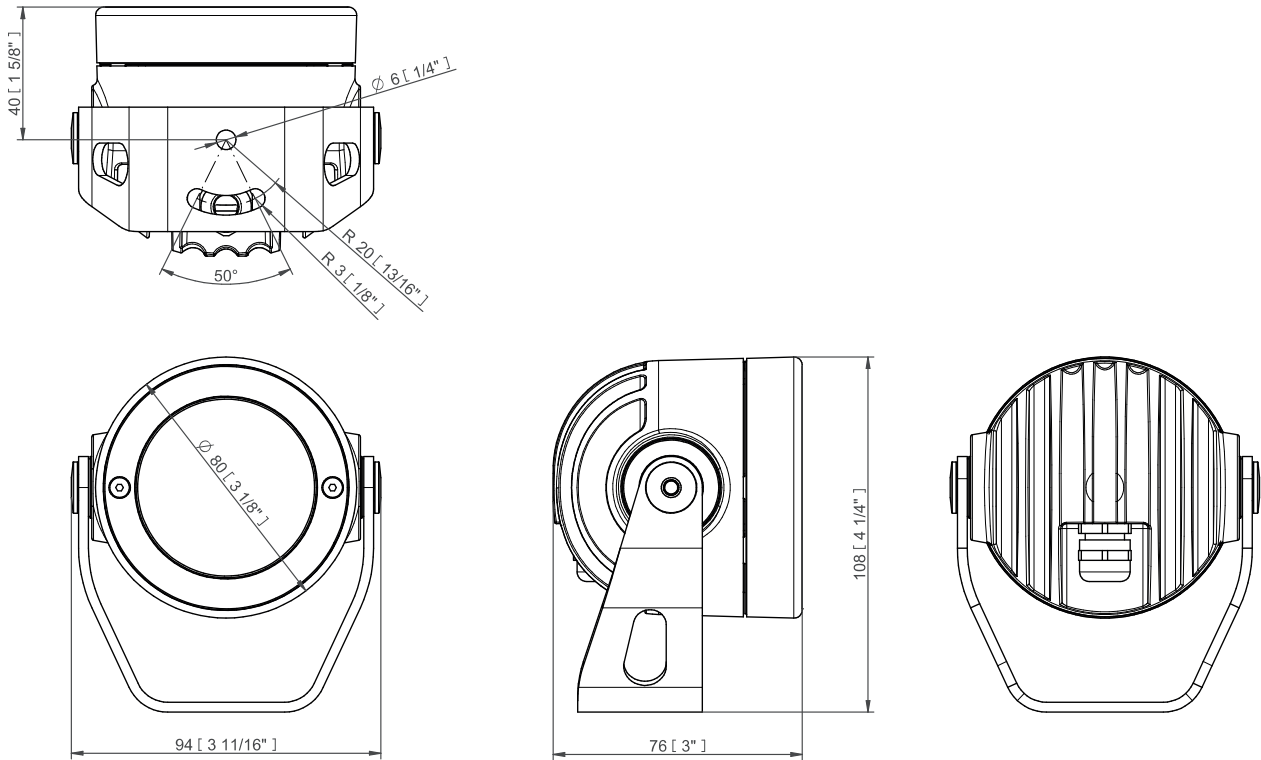

CONTROL AND CONNECTION OPTIONS

Example of Connection Via E-Box REMOTE

- 1) SJTW 5x 14AWG (1305 3336), black or On request Cable SJTW 5x 14AWG (13053697), white
- 2) Junction Box Remote (4x Output)
- 3) UL 20969 5x 20AWG (13053481), black or On request Cable SJTW 5x 20AWG (13053696), white
- 4) Junction Box Remote (1x Output)

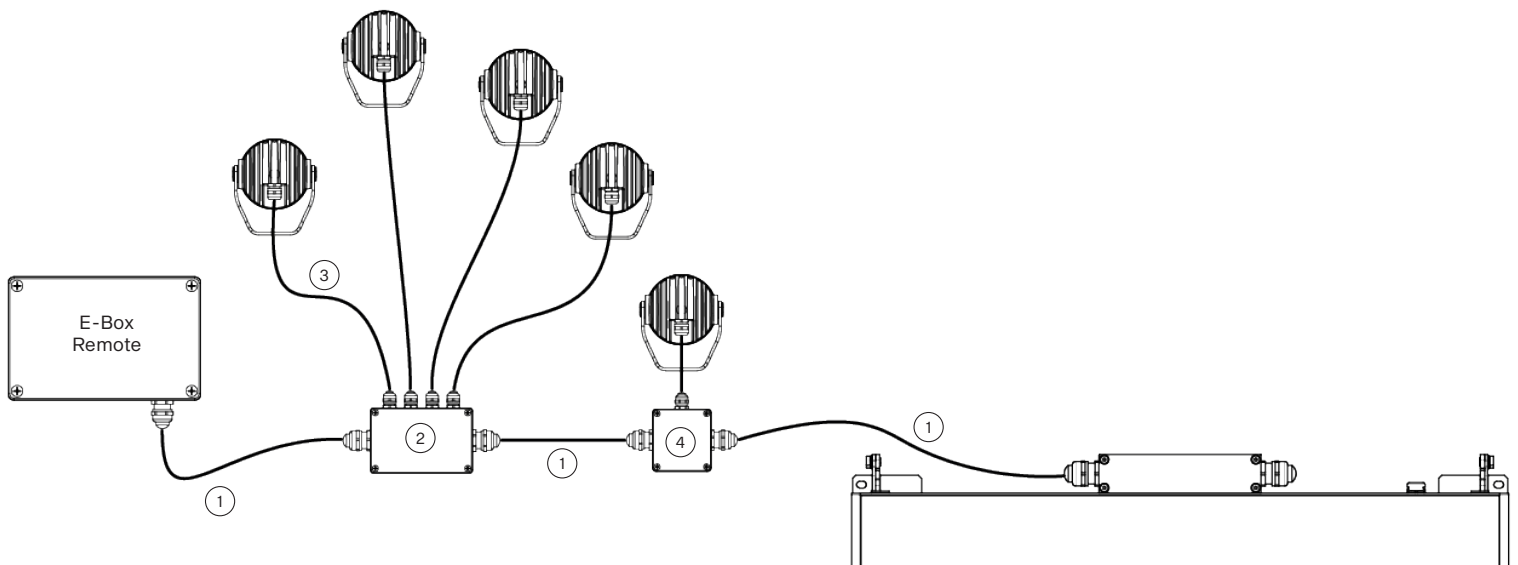

PROJECTED AREA

	Front (rear) - m ²	Front (rear) ft ²	Side - m ²	Side - ft ²	Top - m ²	Top - ft ²
Calumma XS	0,006	0,065	0,007	0,070	0,006	0,065
with Top Hat	0,006	0,065	0,014	0,151	0,014	0,151
with Half Top Hat	0,006	0,065	0,008	0,082	0,014	0,151

CONNECTIVITY

Following table shows maximum connected Calummas XS SC in a row with respect of cable length.

Cable length	Per E-Box Remote	Per 1 LED output
50 m (max per 1 output)	40 pcs	20 pcs
100 m (total length, 2x output)		20 pcs

CONTROL AND CONNECTION OPTIONS

ON/OFF

- 1) UL 20969 5x 20AWG (13053481), black or On request Cable SJTW 5x 20AWG (13053696), white
- 2) Junction Box Remote (4x Output)
- 3) Junction Box Remote (1x Output)

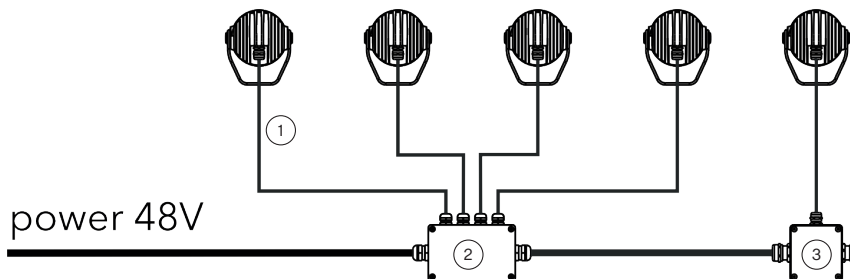

BI-SYMMETRICAL BEAM ANGLES

Bi-symmetrical:
10°x30°,
10°x60°,
15°x45°,
15°x90°,
30°x60°,
30°x90°

Bi-symmetrical:
30°x10°,
60°x10°,
45°x15°,
90°x15°,
60°x30°,
90°x30°

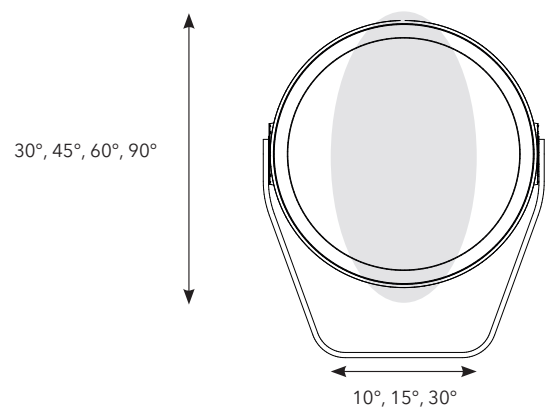
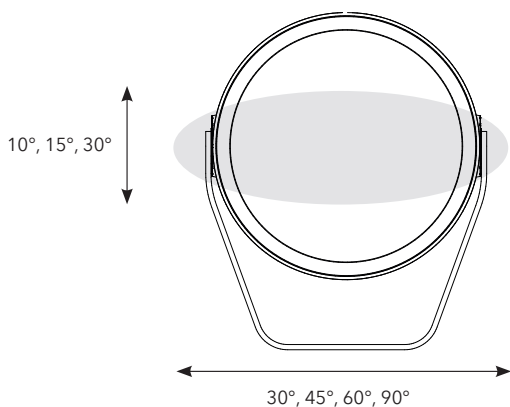

ACCESSORIES

Top Hat

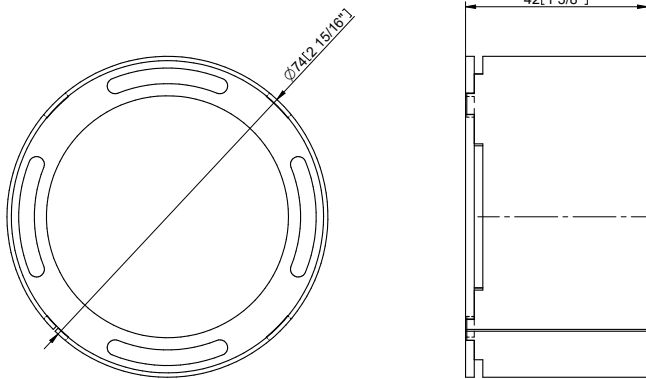

Half Top Hat

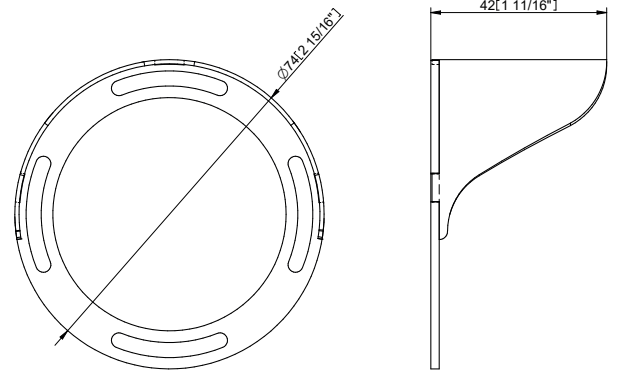

Pole Adaptor (ø 102mm, Yoke for pole Adaptor Required / PA)

Example of ordering code: Calumma XS SC RGBCW 15° PA

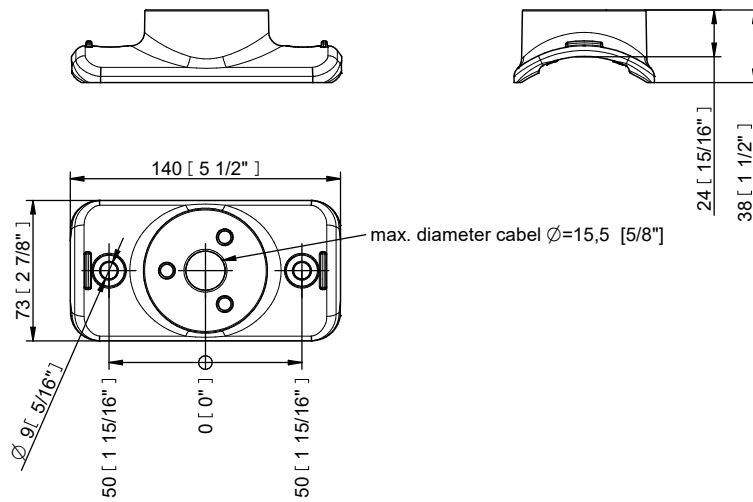

PHOTOMETRIC OVERVIEW

	WW (W 3000 K)
10°	457
15°	416
25°	406
30°	399
45°	407
65°	399
100°	404
10° x 30°, 30° x 10°	401
10° x 60°, 60° x 10°	400
15° x 45°, 45° x 15°	417
30° x 60°, 60° x 30°	397
30° x 90°, 90° x 30°	374
15° x 90°, 90° x 15°	392

PHOTOMETRIC DATA

Calumma XS SC PW 3000K 10dg

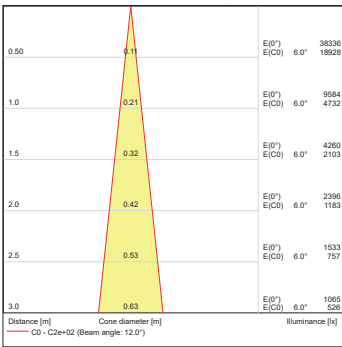
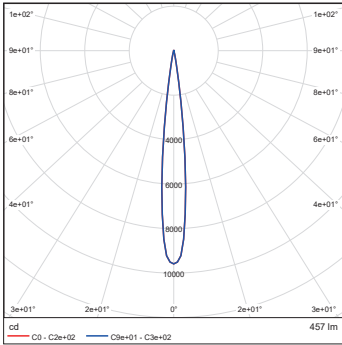

Calumma XS SC PW 3000K 15dg

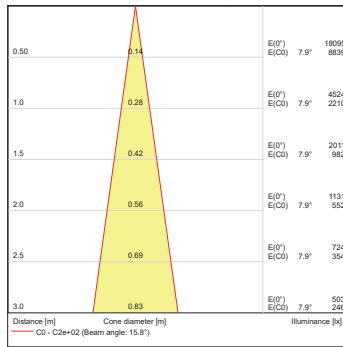
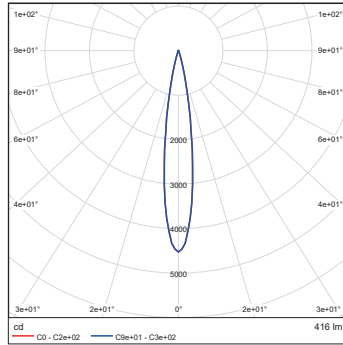

Calumma XS SC PW 3000K 25dg

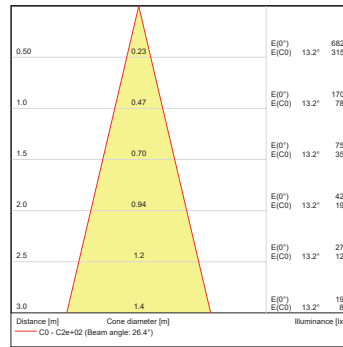
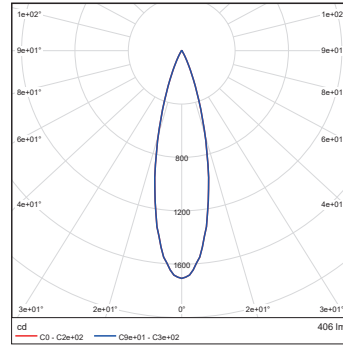

Calumma XS SC PW 3000K 30dg

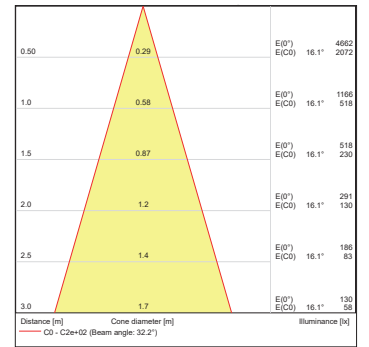
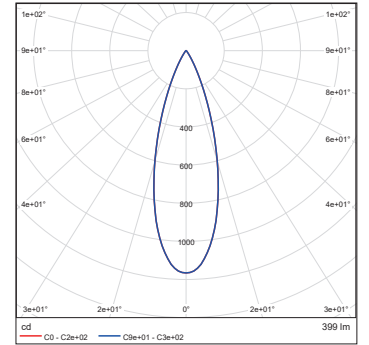

Calumma XS SC PW 3000K 45dg

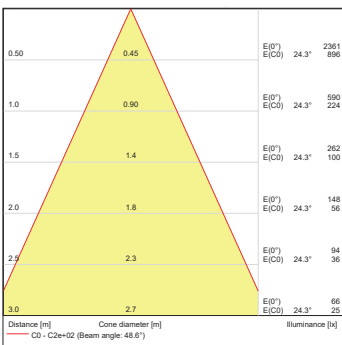
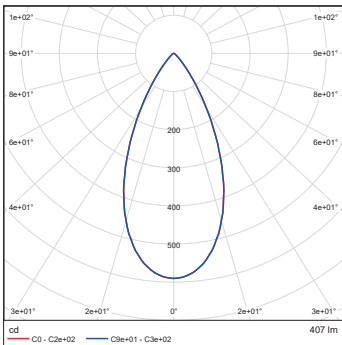

Calumma XS SC PW 3000K 65dg

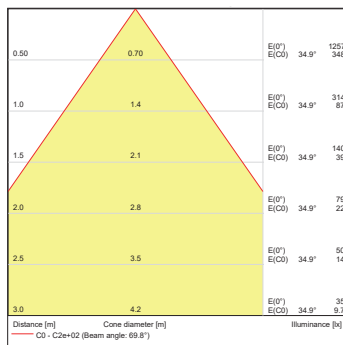
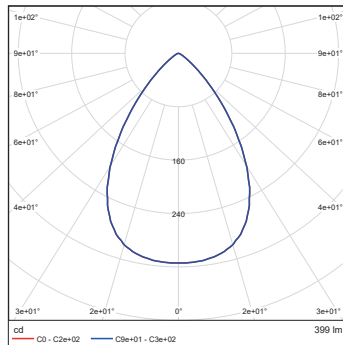

Calumma XS SC PW 3000K 100dg

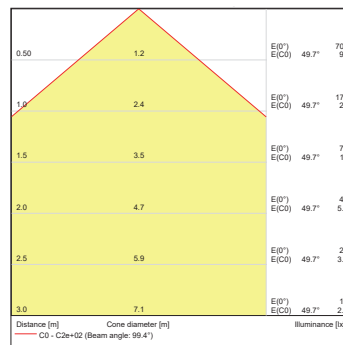
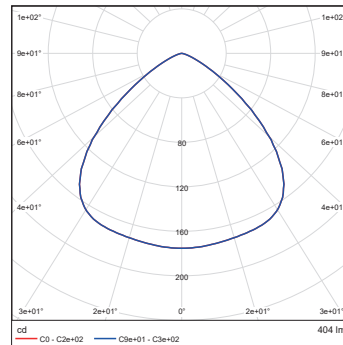

PHOTOMETRIC DATA

Calumma XS SC PW 3000K 10x30dg

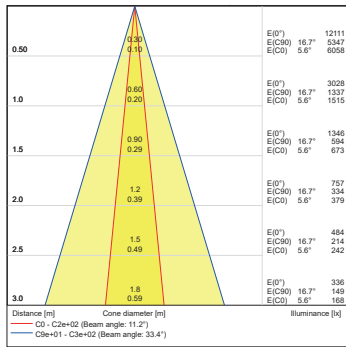
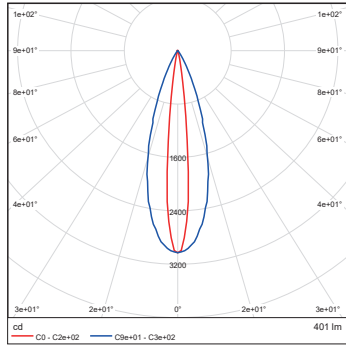

Calumma XS SC PW 3000K 10x60dg

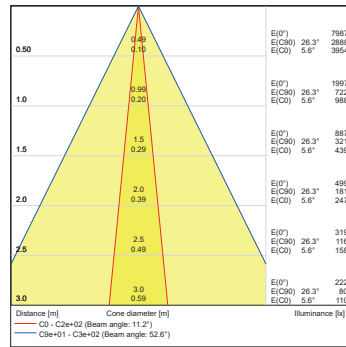
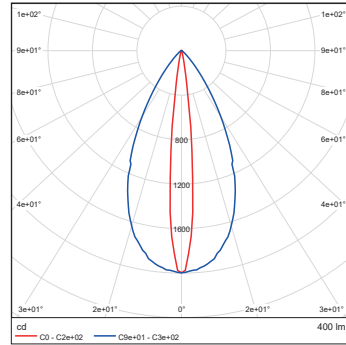

Calumma XS SC PW 3000K 15x45dg

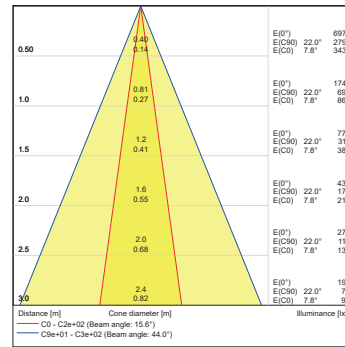
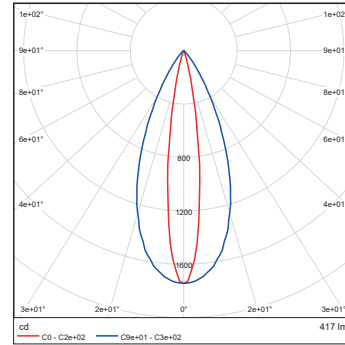

Calumma XS SC PW 3000K 15x90dg

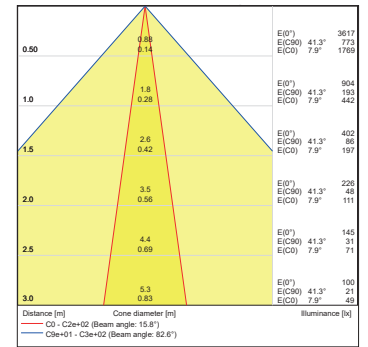
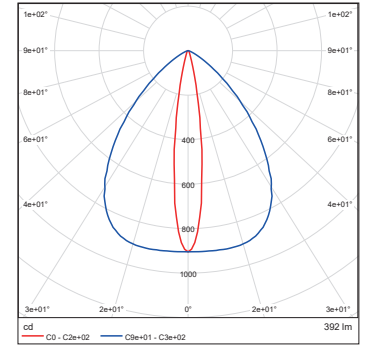

Calumma XS SC PW 3000K 30x60dg

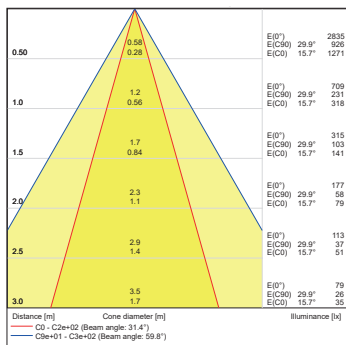
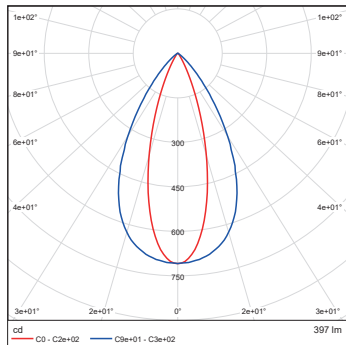

Calumma XS SC PW 3000K 30x90dg

