

AMBIANE® HP111 PENDANT REMOTE

Each Ambiane luminaire is expertly crafted to fit different types of lighting applications. Ambiane HP111 Pendant Remote is meant to fit mid-throw application and able to be mounted onto sloped ceilings. Using the same light source specification as all other Ambiane series members, the fixture is an ideal add-on to lighting designs using a host of Ambiane luminaires. Giving designers and installers a choice of 20, 40, 60 or 80-degree optical beam spreads, the Ambiane HP111 provides an endless array of positioning options across an entire installation. The incorporation of our L3 (Low Light Linearity) dimming system allows seamless fades to black even when mixed with traditional sources. With no UV or IR emissions which make it ideal for museums as well, the fixture is easily controlled via DMX or DALI and is RDM compatible.



KEY FEATURES

LED Output

Available in wide range of colour configurations (RGBW, PW, TW, TD), the Ambiane HP111 Pendant Remote utilises highly efficient LED modules with CRI 90+ ensuring you can always see every colour without colouring distortion. Equally homogenised light output is secured by precisely designed output optics with the highest possible luminous flux 3239 lm and a 90,000 LED lifetime which guarantees low maintenance cost and long-lasting light output. The fixture offers many different beam spreads (20°, 40°, 60° and 80°) for precisely defined light output, required in a lighting installation.

Control

Thanks to our unique L3 (low light linearity) 18-bit dimming system, exceptionally smooth fade to black and colour mixing are now possible. The fixture's remote setting and device management is realised through DALI and DMX512 control protocols with RDM support and intelligent power balancing (always 75 W output in any mixed colour).

Installation

Mounting via ceiling adaptor and adjustable hanging wires allows installation onto sloped ceilings. The Ambiane HP111 Pendant Remote offers the possibility of a backup power connection to protect against any unexpected blackout.

COLOURS

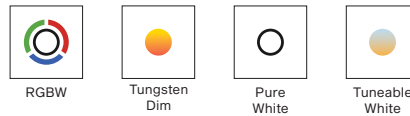

CONTROL & PROTOCOLS



STANDARD & SPECIFICATION

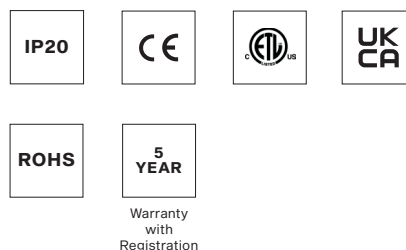

COLOUR TEMPERATURE

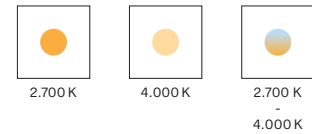

OPTIC OPTIONS

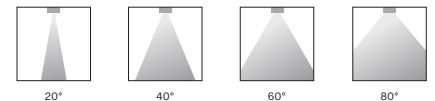

FINISH OPTIONS

* CLOSEST RAL TONE

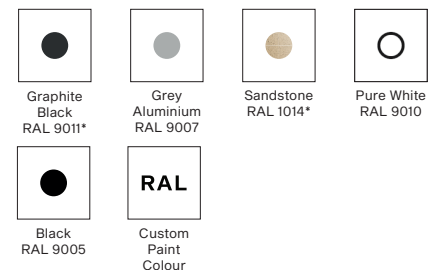

SPECIFICATION SHEET

AMBIANE® HP111 PENDANT REMOTE

SPECIFICATION

ELECTRICAL	Input Voltage	48 V DC			
	Input Voltage range	44-50 V DC			
	Max. Power Consumption (Primary power Secondary power)	75 W 20 W			
	Max. Operating time for Sec. power	3 hours			
OPTICAL	Light Source	High Power LED module			
	Colour Variants	RGBW (W 2700 K or 4000 K)	Pure White	Tunable White	Tungsten Dim
	Colour Temperature of White	PW 2700 K or 4000 K TW 2700-4000 K TD 3200 K			
	CRI	90+			
	Beam Angle	20° 40° 60° 80°	20° with Ring Louver for Ambiane HP111 Pendant Remote		
	Lumen Output Delivered	2.289 lm (RGBNW at 20° 4000 K)		3.239 lm (RGBNW at 60° 4000 K)	
		3.024 lm (RGBNW at 40° 4000 K)		3.145 lm (RGBNW at 80° 4000 K)	
Projected Lumen Maintenance	L90B10 >90.000 hrs, Ta = 25°C / 77°F				
CONTROL	Interface Protocol	USITT DMX512, RDM, DALI 2, 0-10 V			
	DALI 2 Device Type	DT 8			
	Control System	ArcControl Range or any Third Party Controller			
	DMX Modes DNX Channels	5 (for RGBW version) 4, 3, 12, 3, 6			
	Settings / Addressing	DIP Switch			
	Power Supply	Ambiane Power HP (48 V / 100 W)		Ambiane Power Rack (CE/US)	
PHYSICAL	Width x Height x Depth	Ambiane HP111 Pendant Remote 20° - ø129 x 302 mm (ø5.08 x 11.9 in.)			
		Ambiane HP111 Pendant Remote 40° - ø129 x 298 mm (ø5.08 x 11.73 in.)			
		Ambiane HP111 Pendant Remote 60° - ø129 x 285 mm (ø5.08 x 11.22 in.)			
		Ambiane HP111 Pendant Remote 80° - ø129 x 268 mm (ø5.08 x 10.55 in.)			
	Weight	3.1 kg 6.8 lbs @ 20°	3.1 kg 6.8 lbs @ 40°	3 kg 6.6 lbs @ 60°	3 kg 6.6 lbs @ 80°
	Housing	High Pressure Extruded Aluminium Body, Metal cover			
	Finish Options	Standard Color	Graphite Black RAL 9011 Grey Aluminium RAL 9007 Pure White RAL 9010 Sandstone RAL 1014 Black RAL 9005		
		Cost Option	Custom RAL		
	Cables / Connections	Terminal block (Power In, DMX In/Out, DALI In/Out, Secondary Power Input)			
	Mounting Method	Pendant with adjustable hanging wires: Standard: 2.5 m (possibility of shorten on site) Other Lengths: Upon Request (more than 2.5 m)			
	Protection Factor	IP20 / Dry location only			
Cooling System	Convection				
Operating Ambient Temperature	-20 °C / +40 °C (-4 °F / +104 °F)				
Max. Operating Temperature	+75°C (167°F)				
CERTIFICATION	Listings	ETL / cETL, RoHS, CE (including ČSN EN 60598-2-22 / Emergency lighting, ISO17067), UKCA			
ACCESSORIES	Included Items	Control Unit			
	Not Included Items	Ring Louver 20° (Factory Fitted)			
		Ambiane Power HP (MeanWell ELG-100-48-3Y)			
		Ambiane Power Rack (CE/US)			

DIMENSIONS

Ambiane HP111 Pendant Remote (with Ring Louver)

Ambiane HP 20° H = 302 mm [11 7/8 in.]
 Ambiane HP 40° H = 298 mm [11 3/4 in.]
 Ambiane HP 60° H = 285 mm [11 1/4 in.]
 Ambiane HP 80° H = 268 mm [10 9/16 in.]

Fixture has possibility to be mounted on sloped ceiling.
 Possible angle: +90° / -90°

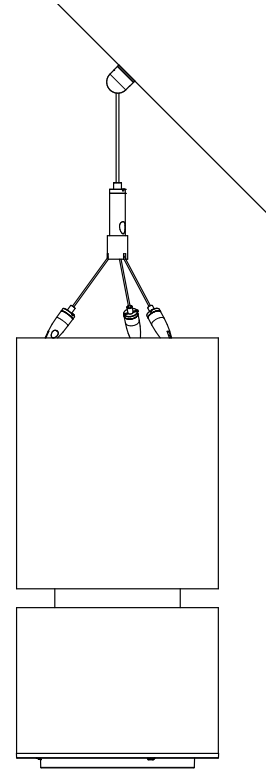
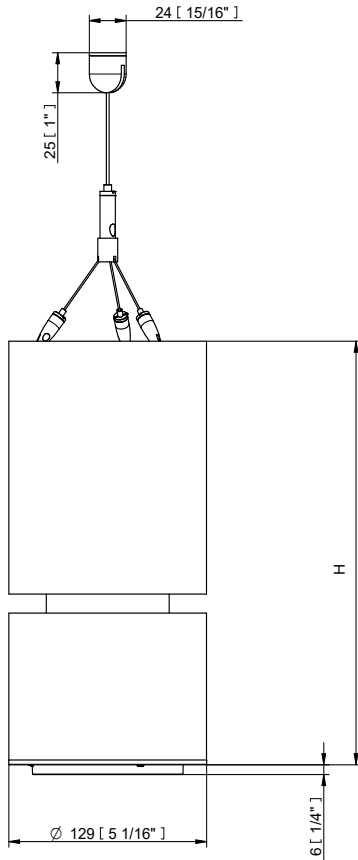

Ambiane HP111 w/Connection Unit

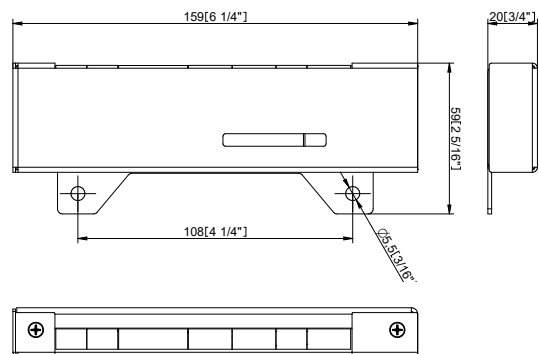
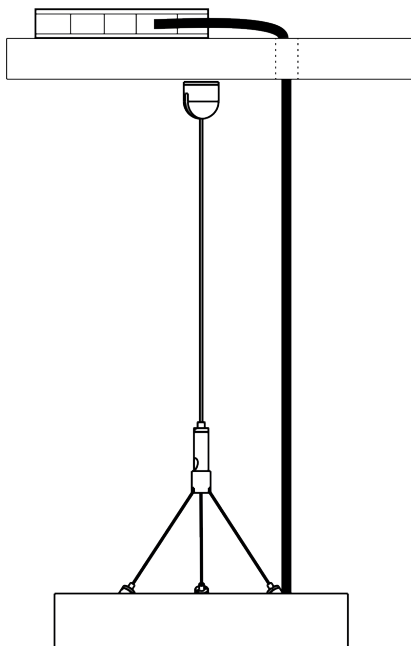

DIAMETER OF CONDUCTORS

Recommended diameters of conductors with respect to distance between Fixture and Power supply.

Distance / Cable length	25 m	50 m	75 m	100 m
Diameters of conductors	0.5 mm ²	1 mm ²	1.5 mm ²	2 mm ²

AMBIANE POWER RACK (CE / US) SPECIFICATION

ELECTRICAL	Input Voltage	100 – 240 V AC 50/60 Hz (Ambiane Power Rack)
		100 – 277 V AC 50/60 Hz (Ambiane Power Rack US)
	Maximal Power Consumption	1350 W
	Output Voltage	48 V DC
	Outputs	8
	Max. Load per output	200 W
	Max. Total Load	1200 W
PHYSICAL	Length x Height x Depth	484 / 432 x 88 x 241 / 202 mm (19.05 / 17 x 3.46 x 9.48 / 7.95 in.)
	Weight	5.4 kg 11.9lbs
	Housing	Rack Standard - 2U or Wall Mounted Brackets
	Finish Options	Standard Colour - Graphite Black (RAL 9011) Silver (RAL9006)
		Cost Option - Custom RAL
	Cables / Connections	8 x Terminal Block (DC power Out)
		1x Main Power Cord (w/plug; CE/US)
	Mounting Method	Designed to Rack Box Installation
	Protection Factor	IP20 / Dry locations only
	Cooling System	Fan Cooled
Operating Ambient Temperature	-20 °C / +40 °C (-4 °F / +104 °F)	
CERTIFICATION	Listings	ETL / cETL, CE, RoHS , UKCA

DIMENSIONS

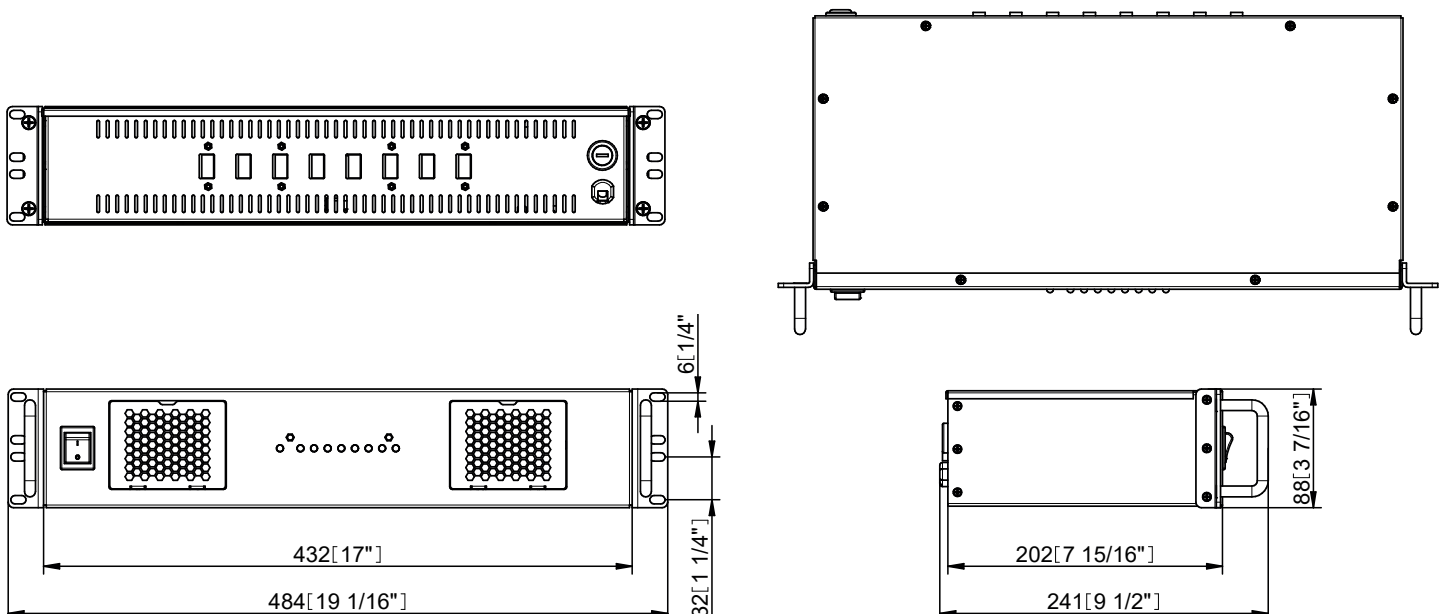

TM30 FOR AMBIANE HP111

NOTE: This is a recommended method for displaying ANSI/IES TM-30-18 information.

RGBWW VERSION

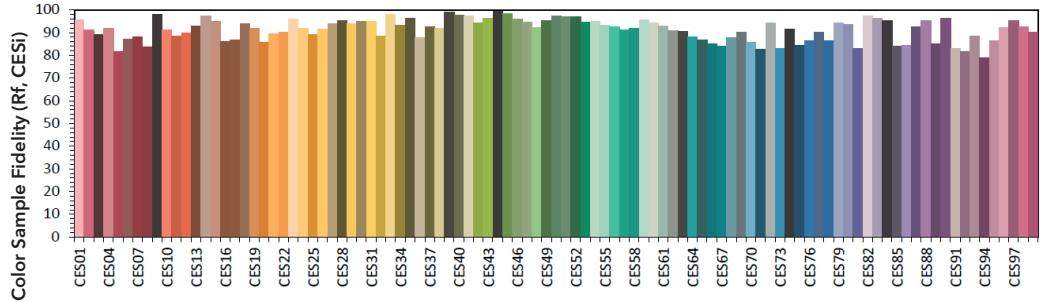
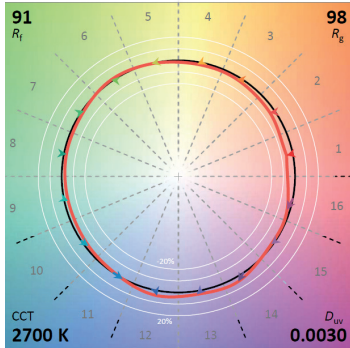

RGBNW VERSION

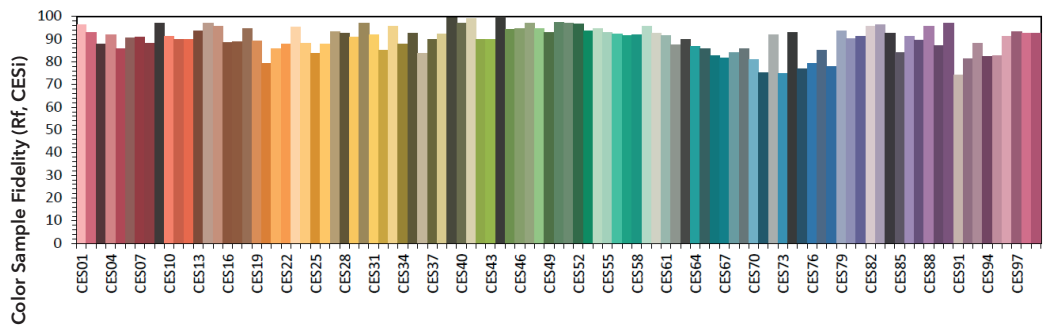
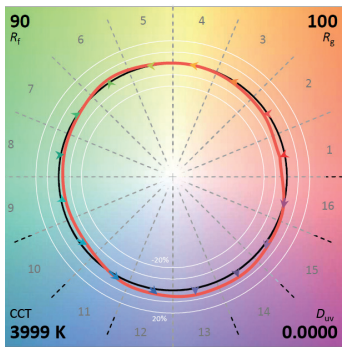

PHOTOMETRIC OVERVIEW

Lumen Output (lm)

	RGBWW (2700 K)	RGBNW (4000 K)	PW (2700 K)	PW (4000 K)	TW (2700 - 4000 K)	TD (3200 K)
20° with Louver	1 109	1 488	1 526	1 911	1 109 - 1 488	1 500
20° without Louver	1 705	2 289	2 347	2 940	1 705 - 2 289	2 307
40°	2 253	3 024	3 101	3 884	2 253 - 3 024	3 048
60°	2 413	3 239	3 321	4 160	2 413 - 3 239	3 265
80°	2 343	3 145	3 225	4 039	2 343 - 3 145	3 170

UNIFIED GLARE RATING (UGR)

UGR	
20° (with Louver / without Louver)	<7 UGR / <17 UGR
40°	< 21 UGR
60°	< 22 UGR
80°	< 25 UGR

PHOTOMETRIC DATA

Ambiane HP111 RGBNW 20dg with Ring Louver

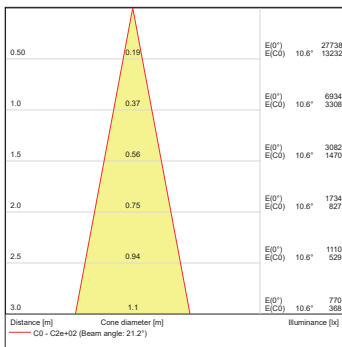
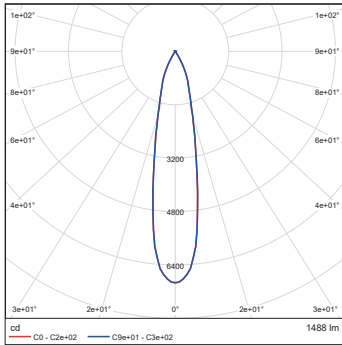

Ambiane HP111 RGBNW 20dg without Ring Louver

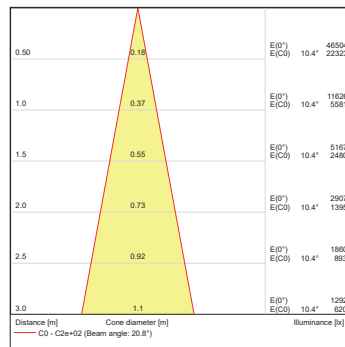
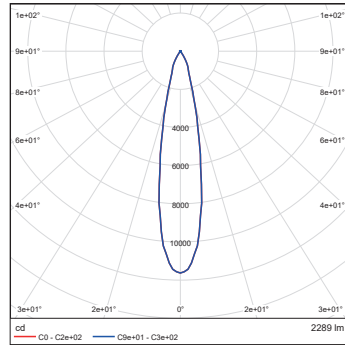

Ambiane HP111 RGBNW 40dg

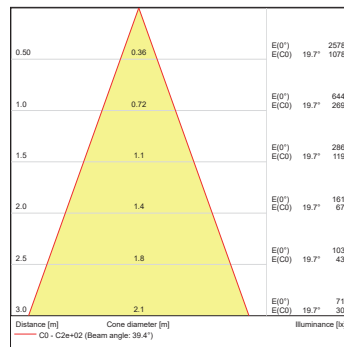
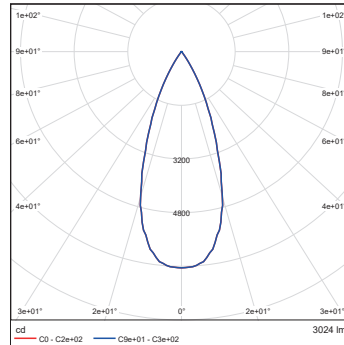

Ambiane HP111 RGBNW 60dg

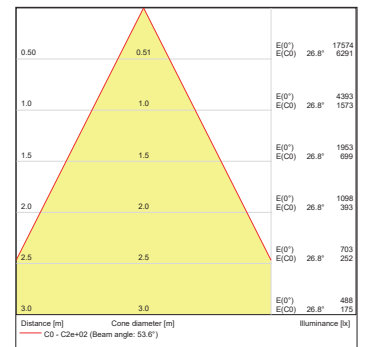
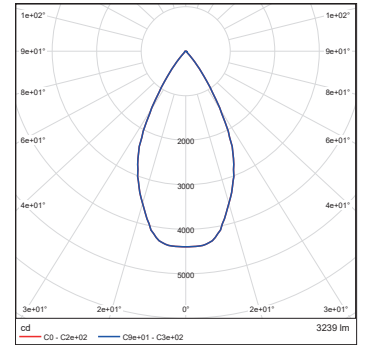

Ambiane HP111 RGBNW 80dg

