

CALUMMA™ XL SC

Featuring an optical design using 121 high efficacy single-chip LEDs and available with optional LED colour variants and various beam angles, the extra large-sized Calumma XL SC luminaire creates powerful and beautiful light output for a spot, accent or flood lighting solution. Its durable housing is built to withstand any exterior conditions, and its special finish for harsh and marine environments provides an exceptional outdoor LED luminaire in an elegant design. Additionally, Calumma XL SC can be connected in long In/Out daisy-chains via an E-Box and hybrid Plug & Play connections for almost effortless installation. Complemented by wide range of accessories and control protocols, this luminaire is an effective and versatile unit to get the most out of architectural lighting applications.



KEY FEATURES

Lumen output & Light source

Luminaire with 121 high-power, singlechip LEDs provides up to 10955 lumen output. Multiple LED colour variants. No light spills. Well homogenised light output with great efficacy up to 59 lm/w.

Design & Durability

Compact, durable and stylish housing made of high-pressure die cast aluminium. IP67 and IK10 certification; suitable for marine applications (Harsh Environment Finish required) and traffic applications. Supported with a 5 year warranty.

Flexibility

Exceptional outdoor or indoor LED luminaire with a wide range of accessories, custom colour finishes, multiple light output variants and beam angles.

Connectivity

Utilising the innovative E-Box series of power and data interfaces, Calumma XL SC can communicate via numerous wired, wireless, and Ethernet based control protocols. Various wiring topologies are supported using hybrid power / data cables with Plug & Play connectors or standard connection options.

COLOURS

* UPON REQUEST



CONTROL & PROTOCOLS



PW & SINGLE COLOUR ONLY

STANDARD & SPECIFICATION



FINISH OPTIONS

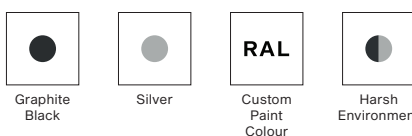

COLOUR TEMPERATURE

* UPON REQUEST

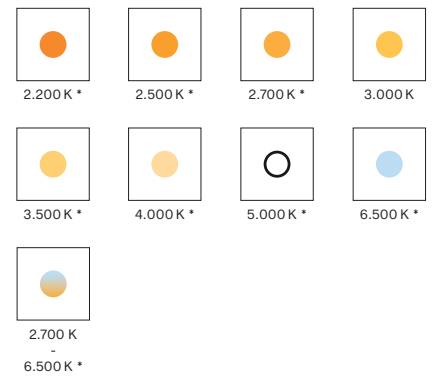

OPTIC OPTIONS

SYMMETRICAL

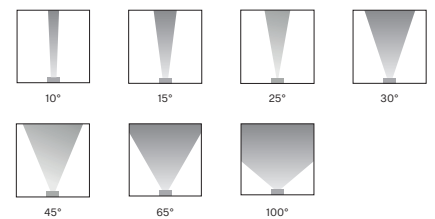

BI-SYMMETRICAL

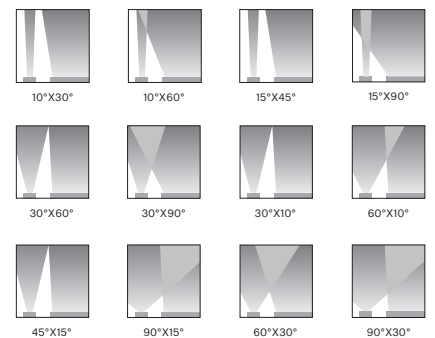

CALUMMA XL SC SPECIFICATION

ELECTRICAL	Input Voltage	120 - 277 V AC 50/60 Hz (US)	
	Typical Power Consumption	185 W +/-10 %	
OPTICAL	Light Source	High Power Single Chip LEDs	
	Colour Variants	RGBW (W - 6500 K) RGBA PW (W - 3000 K)	
		Other Variants On Request (TW (2700 - 6500 K), 2200 K, 2500 K, 2700 K, 3500 K, 4000 K, 5000 K, 6500 K)	
	Beam Angle	10° 15° 25° 30° 45° 65° 100°	
		10°x30° 30°x10° 10°x60° 60°x10° 15°x45° 45°x 15° 15°x90° 90°x15° 30°x60° 60°x30° 30°x90° 90°x30°	
	Lumen Output Delivered	10955 lm (@10° RGBW)	
	Projected Lumen Maintenance	L90B10 >90.000 hrs, Ta = 25°C / 77°F	
CONTROL	Interface Protocol	Via E-box range, DMX/RDM, wireless DMX, DALI 2 or ON/OFF (PW & single color only)	
	E-box control protocol	USITT DMX512+RDM, ArtNet, MA Net, MA Net2, sACN, Kling-Net	
	DALI 2 Device Type	DT 8	
	Wireless DMX (Option)	Lumen Radio CRMX Technology	
	Control System	Third Party DMX Controllers or third party DALI 2 controllers, Ethernet	
	Operating Modes	DMX, Stand-alone	
	Settings / Addressing	E-box, RDM communicator	
	Power Supply	Integrated	
	Width x Height x Depth	385 x 404 x 120 mm (15.16 x 15.91 x 4.72 in.)	
	Weight	13 kg / 28.7 lbs	
Housing	High Pressure Die-Cast Aluminium Body		
	Tempered Glass		
Finish Options	Standard Colour - Graphite Black (RAL 9011) Silver (RAL 9006)		
	Cost Option - Custom RAL Harsh Environment (RAL 9016, RAL 9011)		
PHYSICAL	Cables / Connections	IN/OUT (for E- Box version):	IN (for DMX, DALI, ON /OFF):
		- 0,5 m cables with hybrid connectors - Jumper cables	- 1 m cable with bare end - Other cable length - custom - Junction box - optional
	Mounting Method	Yoke or Yoke for Pole Adaptor	
	Adjustability	+180° / -180°	
	Protection Factor	IP67 / Suitable For Wet Locations	
	IK Rating	IK10	
	Cooling System	Convection	
	Operating Ambient Temperature	-20 °C / +50 °C (-4 °F / +122 °F)	
CERTIFICATION	Listings	ETL / cETL, CE, RoHS, UKCA	
ACCESSORIES	Not Included Items		
		Junction Box for Calumma	
		Optical Demo Set for Calumma XL (for demo purposes)	
		Outdoor Foil Holder for Calumma XL (for permanent installation)	
		Optical Foil Set for Outdoor Foil Holder Calumma XL	
		Land Spike for Calumma XL	
		Top Hat Calumma XL	
		Half Top Hat Calumma XL	
		Tenon Adaptor for Calumma XL	
		Floor stand for Calumma L, XL	
		Pole Adaptor (ø 102mm) (Yoke for Pole Adaptor Required)	

PROJECTED AREA

	Front (rear) - m ²	Front (rear) ft ²	Side - m ²	Side - ft ²	Top - m ²	Top - ft ²
Calumma XL	0,105	1,130	0,044	0,469	0,042	0,446
with Top Hat	0,105	1,130	0,107	1,151	0,105	1,130
with Half Top Hat	0,105	1,130	0,064	0,684	0,105	1,130

DIMENSIONS

Standard Yoke

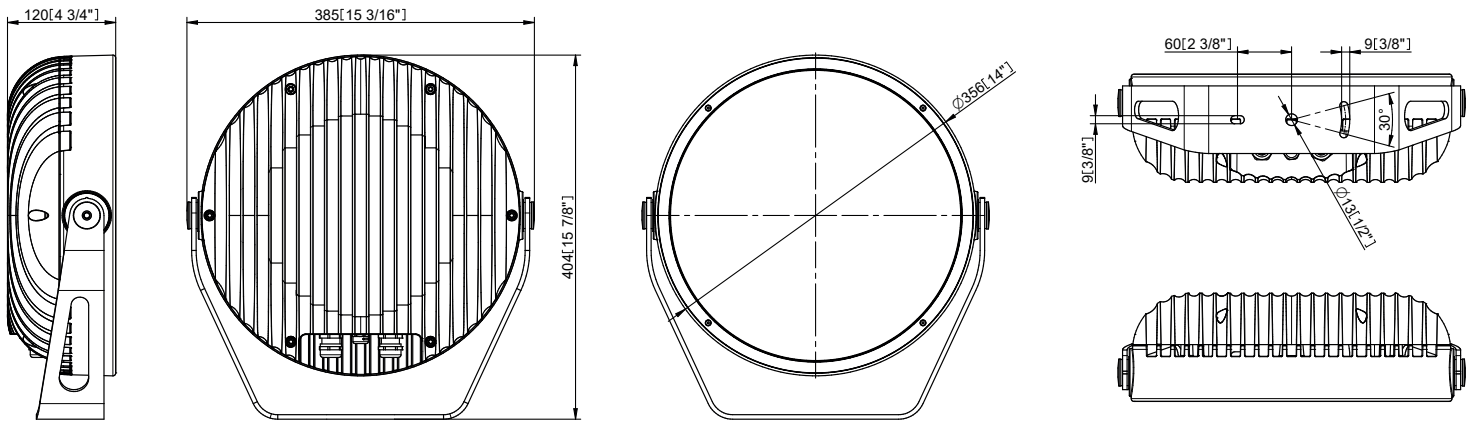

Yoke for Pole Adaptor (with Pole Adaptor / PA)

Example of ordering code: Calumma XL SC RGBCW 15° PA

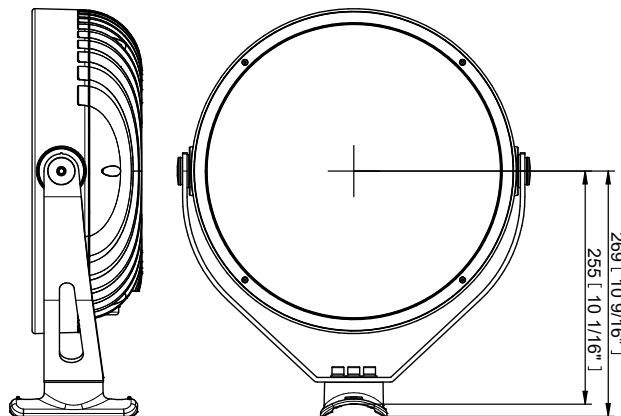

CONTROL AND CONNECTION OPTIONS - CE

DALI

- 1) Hybrid Cable (1305 3693)
Standard 1 m with bare-end
- 2) Hybrid Cable (1305 3693)
or
Scope of Others
- 3) Junction Box for Calumma

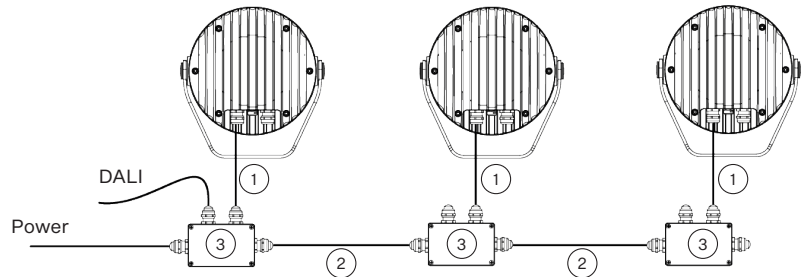

DMX

- 1) Flamar 3x AWG 16 + 1 x (2x AWG 24)
Standard 1 m with bare-end, (13051508), black
or
Hybrid Cable HYB-5731ZH LSZH (13053694), white
- 2) Flamar 3x AWG 16 + 1 x (2x AWG 24), (13051508), black
or
Hybrid Cable HYB-5731ZH LSZH (13053694) white
or
Scope of Others
- 3) Junction Box for Calumma

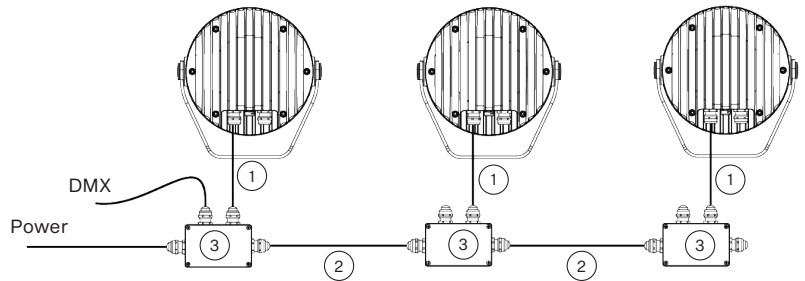

WIRELESS DMX

- 1) Flamar 3x AWG 16 + 1x (2x AWG 24),
(13051508), Standard 1 m bare-end, black
or
Hybrid Cable HYB-5731ZH LSZH (13053694), white
- 2) Junction Box for Calumma

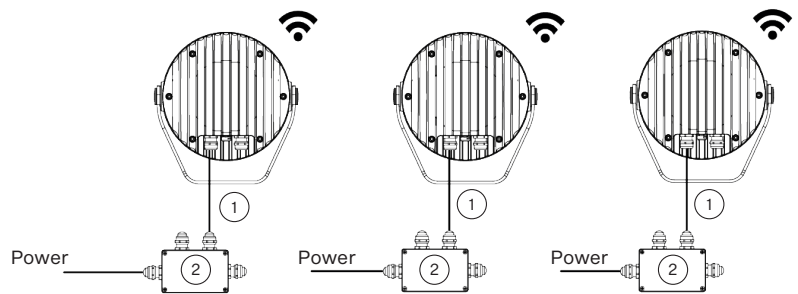

Note: This type of connection is available for M, L, XL versions.

- 1) Flamar 3x AWG 16 + 1x (2x AWG 24)
(13051508), Standard 1 m bare-end, black
or
Hybrid Cable HYB-5731ZH LSZH (13053694), white
- 2) Junction Box for Calumma
- 3) Flamar 3x AWG 16 + 1 x (2x AWG 24), (13051508)
or
Hybrid Cable HYB-5731ZH LSZH (13053694), white
or
Scope of Others

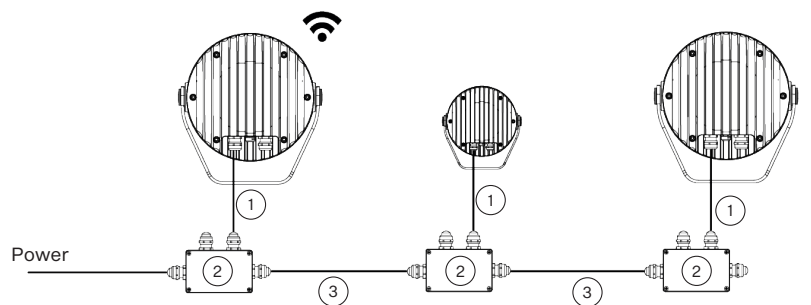

Note: This type of connection must have M, L or XL versions as the first luminaire. Next luminaires in a row could be chosen from S, M, L or XL versions.

CONTROL AND CONNECTION OPTIONS - CE

DMX or ETHERNET via E-BOX

- 1) Flamar 3x AWG 16 + 1x (2x AWG 24) (13051508), Standard 1 m with bare-end, black or Hybrid Cable HYB-5731ZH LSZH (13053694), white
- 2) Junction Box for Calumma
- 3) Flamar 3x AWG 16 + 1x (2x AWG 24), (13051508), black or Hybrid Cable HYB-5731ZH LSZH (13053694) white or Scope of Others

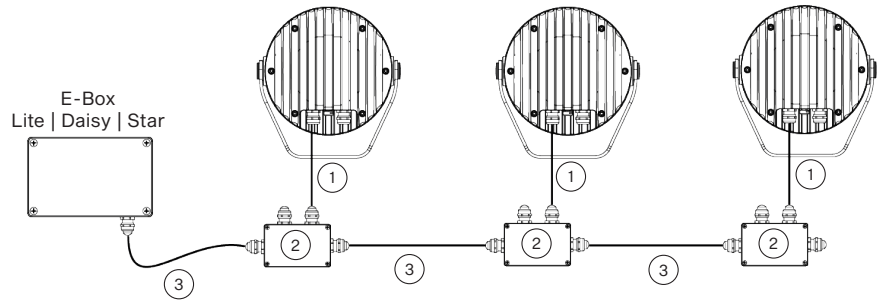

Note: This type of connection is available for S, M, L, and XL versions. E-Box has to be in Pass Through mode only.

- 1) Leader Cable MM (13053493) Standard 0,5 m with hybrid connector
- 2) Leader Cable MF (13053494) Standard 0,5 m with hybrid connector
- 3) Leader Cable FF 2 m (13053438)
Leader Cable FF 5 m (13053440)
Leader Cable FF 10 m (13053436)
Leader Cable FF 25 m (13053437)
Leader Cable FF 50 m (13053439)

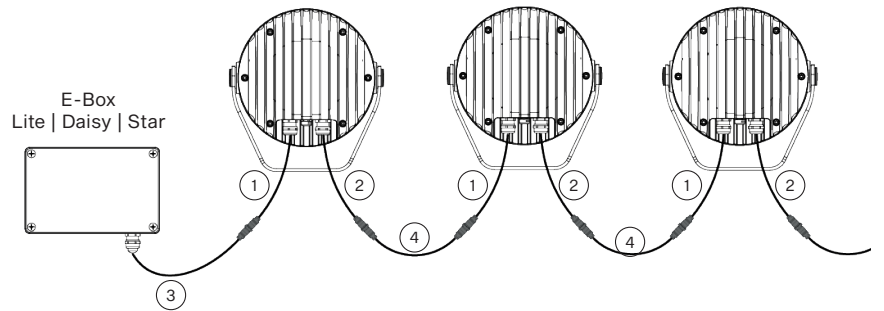

- 4) Jumper Cable FF/FM 0,25 m (13053422)
Jumper Cable FF/FM 0,5 m (13053423)
Jumper Cable FF/FM 1 m (13053425)
Jumper Cable FF/FM 2 m (13053427)
Jumper Cable FF/FM 3 m (13053428)
Jumper Cable FF/FM 5 m (13053430)
Jumper Cable FF/FM 10 m (13053424)

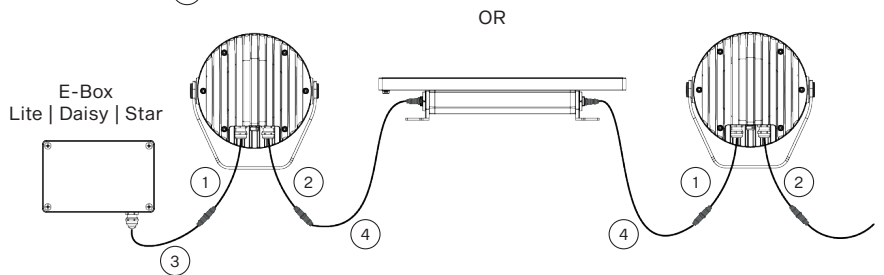

Note: With this type of connection is possible to connect Calumma (M, L, XL) and Eminere (Eminere, Eminere Side) luminaires in a row.

ON/OFF

- 1) 3-cored cable H07BB-F 3G 1.5 (1305 1443), Standard 1 m with bare-end

Note: This type of connection is available for Pure White and single color version only. Non dimmable.

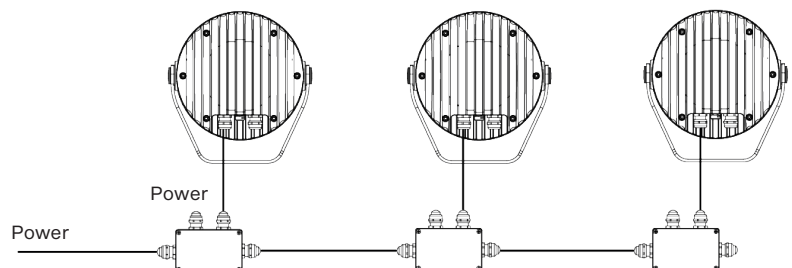

CONTROL AND CONNECTION OPTIONS - US

DALI

- 1) SJTW 5x 14AWG (13053336), Standard 1 m with bare-end, black
or
Cable SJTW 5x 14AWG (13053697), white
- 2) SJTW 5x 14AWG (13053336), black
or
Cable SJTW 5x 14AWG (13053697), white
or
Scope of Others
- 3) Junction Box for Calumma

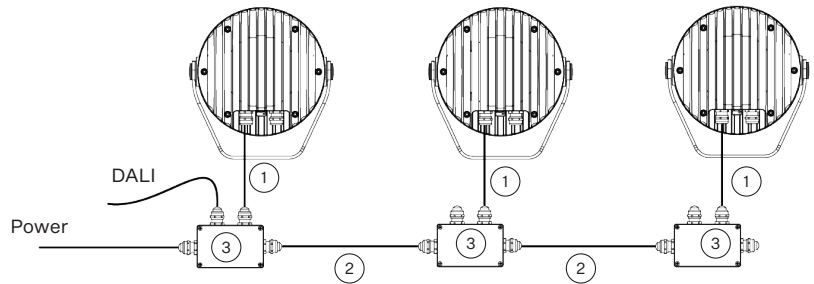

WIRELESS DMX

- 1) SJTW 6x 14AWG (13053480), Standard 1 m with bare-end, black
or
Cable SJTW 6x 14AWG (13053695), white
- 2) Junction Box for Calumma

Note: This type of connection is available for M, L, XL versions

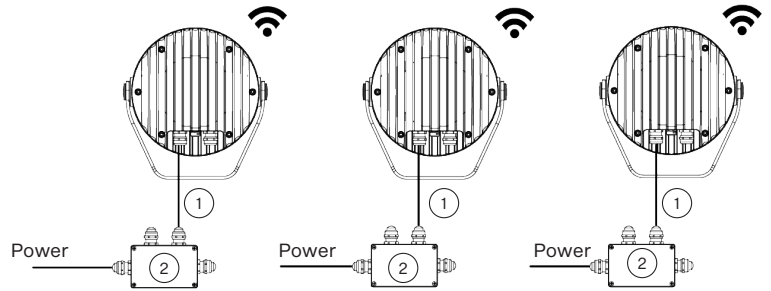

- 1) SJTW 6x 14AWG (13053480), Standard 1 m with bare-end, black
or
Cable SJTW 6x 14AWG (13053695), white
- 2) Junction Box for Calumma
- 3) SJTW 6x 14AWG (13053480), black
or
Cable SJTW 6x 14AWG (13053695), white
or
Scope of Others

Note: This type of connection must have M, L or XL versions as the first luminaire. Next luminaires in a row could be chosen from S, M, L or XL versions.

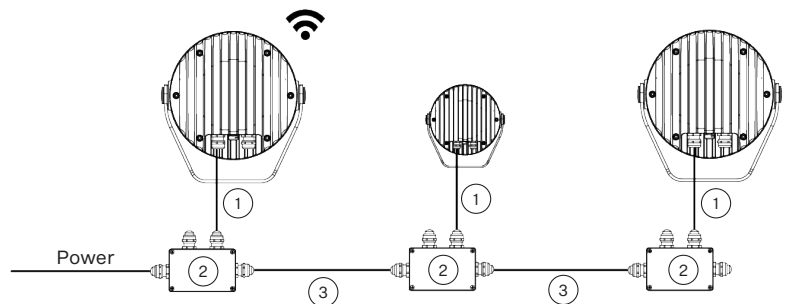

CONTROL AND CONNECTION OPTIONS - US

DMX or ETHERNET via E-BOX

- 1) SJTW 6x 14AWG (13053480)
Standard 1 m with bare-end, black
or
Cable SJTW 6x 14AWG (13053695), white
- 2) Junction Box for Calumma
- 3) SJTW 6x 14AWG (13053480), black
or
Cable SJTW 6x 14AWG (13053695), white
or
Scope of Others

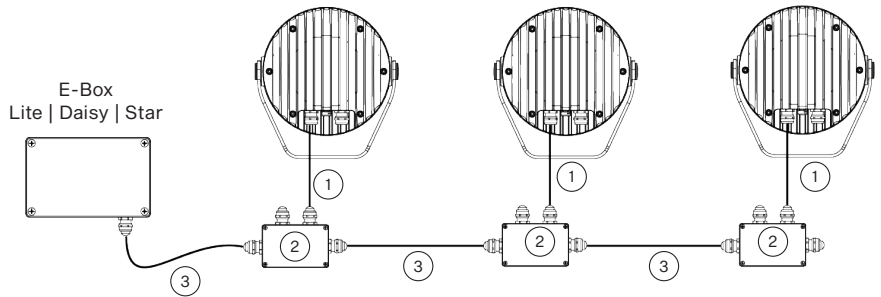

Note: This type of connection is available for S, M, L, and XL versions. E-Box has to be in Pass Through mode only.

ON/OFF

- 1) 3-cored cable SE00W power 3x16 AWG (13051558-01), Standard 1 m with bare-end

Note: This type of connection is available for Pure White and single color version only. Non dimmable.

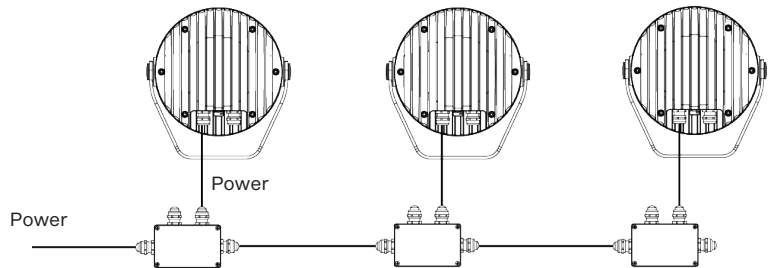

CONNECTIVITY

Following table shows maximum connected Calummas XL SC in a row with respect of cable length.

STANDARD MODE	Cable length (m)	Voltage (V)			
		120	190	230	277
CALUMMA XL SC	10	10	16	19	23
	20	10	16	19	23
	30	7	16	19	23
	50	4	10	15	22
	70	3	7	11	16
	100	2	5	8	11
	200	1	3	4	6
	500	0	1	2	2

PASS-THROUGH MODE	Cable length (m)	Voltage (V)			
		120	190	230	277
CALUMMA XL SC	10	10	16	19	23
	20	10	16	19	23
	30	7	16	19	23
	50	4	10	15	22
	70	3	7	11	16
	100	2	5	8	11

BOOSTER BOX POSITIONS

	Cable length (m)	Max. number of Calummas XL SC= 191 (in Standard mode)			
		120 V	190 V	230 V	277 V
CALUMMA XL SC	10 m	10, 20	16	19	23
	20 m	10, 20, 30, 40, 50	16, 32, 48	19, 38	23, 46
	30 m	7, 14, 21, 28, 35, 42, 49, 56, 64...	16, 32, 48, 64	19, 38, 57, 76	23, 46, 69
	50 m	4, 8, 12, 16, 20, 24, 28, 32, 36, 40, 44, 48, 52, 56, 60, 64, 68, 72, 76, 80, 84...	10, 20, 30, 40, 50, 60, 70, 80, 90, 100...	15, 30, 45, 60, 75, 90, 105..	22, 44, 66, 88, 110...
	70 m	3, 6, 9, 12, 15, 18, 21, 24, 27, 30, 33, 36, 39, 42, 45, 48, 51, 54, 57, 60, 63, 66, 69, 72, 75, 78, 81...	7, 14, 21, 28, 35, 42, 49, 56, 63, 70, 77, 84, 91, 98...	11, 22, 33, 44, 55, 66, 77, 88, 99, 110, 121...	16, 32, 48, 64, 80, 96, 112...
	100 m	2, 4, 6, 8, 10, 12, 14, 16, 18, 20...	5, 10, 15, 20, 25, 30, 35, 40, 45...	8, 16, 24, 32, 40, 48, 56, 64, 72, 80, 88, 96...	11, 22, 33, 44, 55, 66, 77, 88, 99, 110, 121...
	200 m	1, 2, 3, 4, 5, 6, 7, 8, 9, 10, 11....	3, 6, 9, 12, 15, 18, 21, 24, 27, 30, 33, 36, 39, 42, 45, 48, 51, 54, 57, 60, 63, 66, 69, 72, 75, 78, 81...	4, 8, 12, 16, 20, 24, 28, 32, 36, 40, 44, 48, 52, 56, 60, 64, 68, 72, 76, 80, 84...	6, 12, 18, 24, 30, 36...
	500 m	-	1, 2, 3, 4, 5, 6, 7, 8, 9, 10, 11....	2, 4, 6, 8, 10, 12, 14, 16, 18, 20...	2, 4, 6, 8, 10, 12, 14, 16, 18, 20...

NOTE: For more detail see the User manual.

ACCESSORIES

Half Top Hat

Top Hat

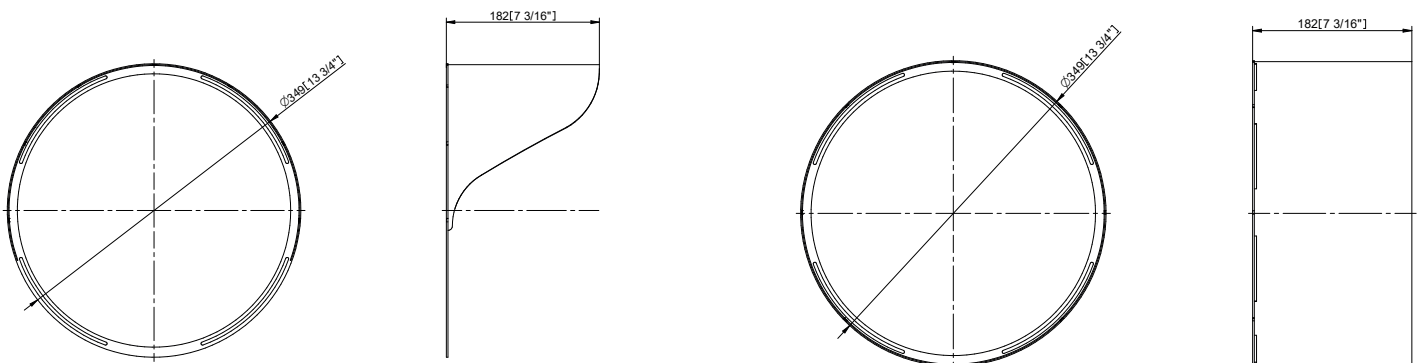

Floor Stand

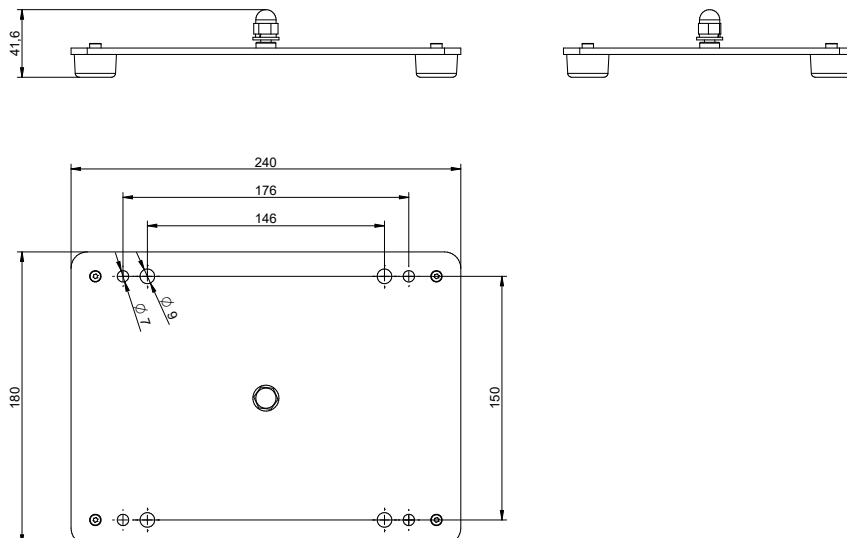

Pole Adaptor

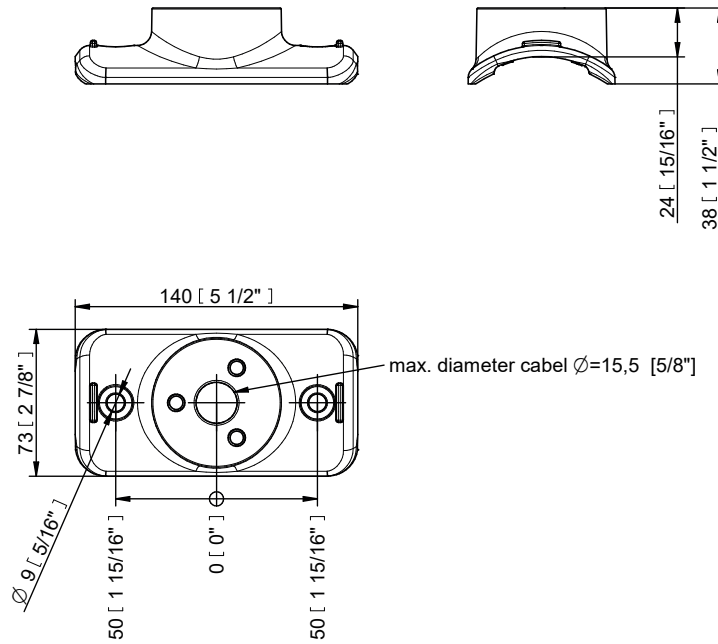

PHOTOMETRIC OVERVIEW

Lumen Output (lm)

	RGBCW (W 6500 K)	RGBA	WW (W 3000 K)
10°	10955	7682	13561
15°	9982	6999	12356
25°	9755	6840	12075
30°	9575	6714	11853
45°	9777	6856	12103
65°	9585	6721	11865
100°	9704	6804	12012
10° x 30°, 30° x 10°	9638	6758	11931
10° x 60°, 60° x 10°	9591	6725	11872
15° x 45°, 45° x 15°	10007	7017	12387
30° x 60°, 60° x 30°	9534	6685	11802
30° x 90°, 90° x 30°	8986	6301	11124
15° x 90°, 90° x 15°	9437	6617	11682

BI-SYMMETRICAL BEAM ANGLES

Bi-symmetrical:

- 10°x30°,
- 10°x60°,
- 15°x45°,
- 15°x90°,
- 30°x60°,
- 30°x90°

10°, 15°, 30°

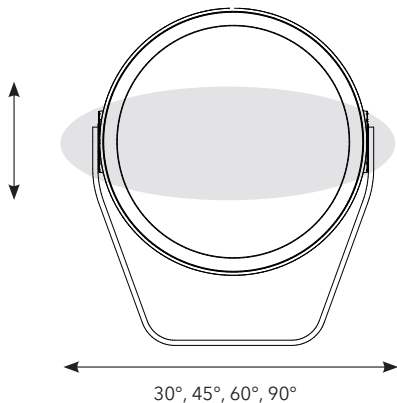

Bi-symmetrical:

- 30°x10°,
- 60°x10°,
- 45°x15°,
- 90°x15°,
- 60°x30°,
- 90°x30°

30°, 45°, 60°, 90°

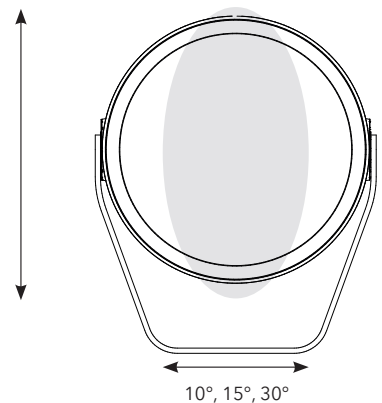

PHOTOMETRIC DATA

Calumma XL SC RGBW 6500K 10dg

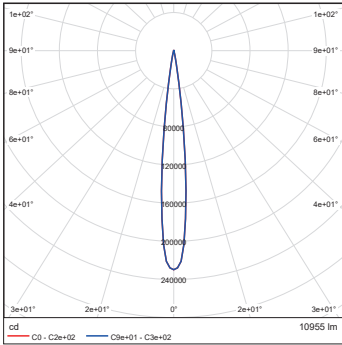

Calumma XL SC RGBW 6500K 15dg

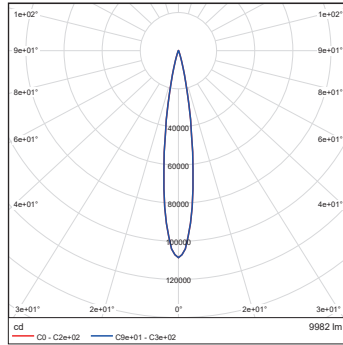

Calumma XL SC RGBW 6500K 25dg

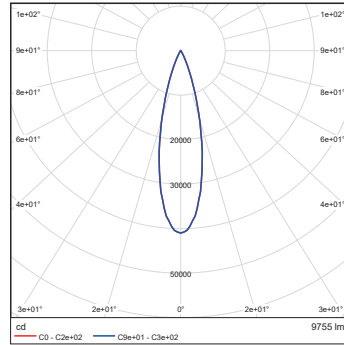

Calumma XL SC RGBW 6500K 30dg

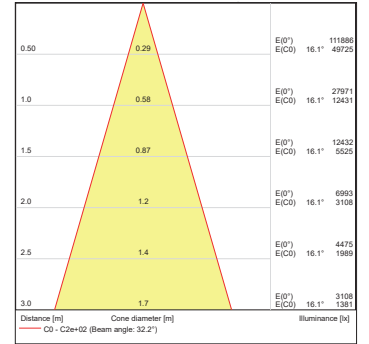
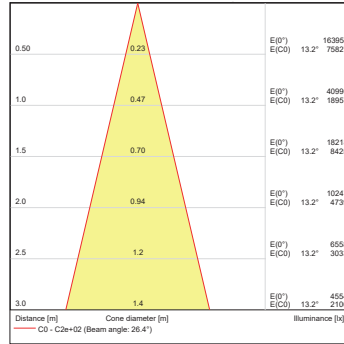
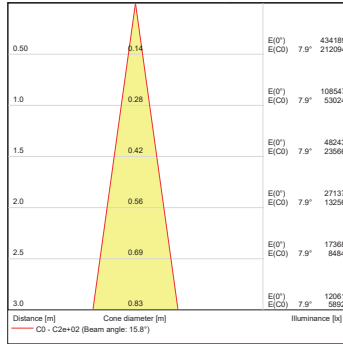
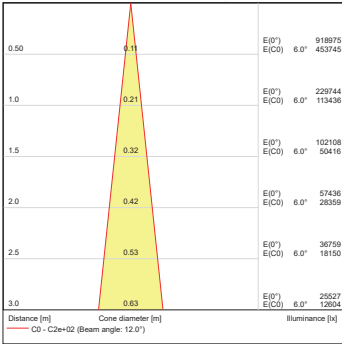
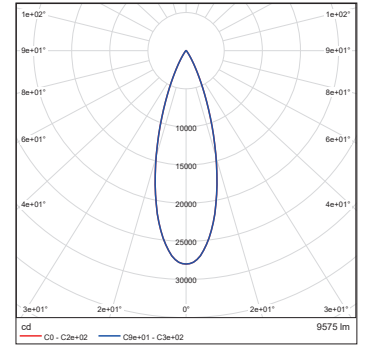

Calumma XL SC RGBW 6500K 45dg

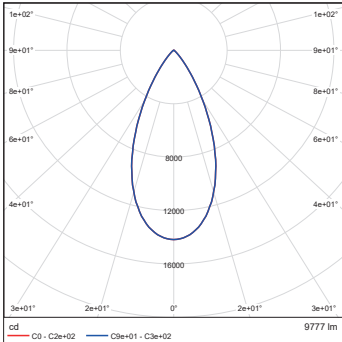

Calumma XL SC RGBW 6500K 65dg

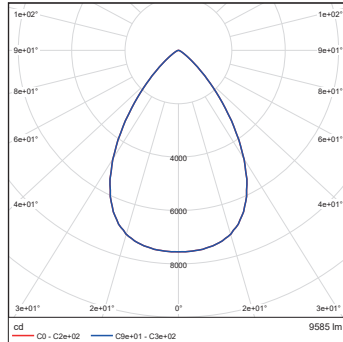

Calumma XL SC RGBW 6500K 100dg

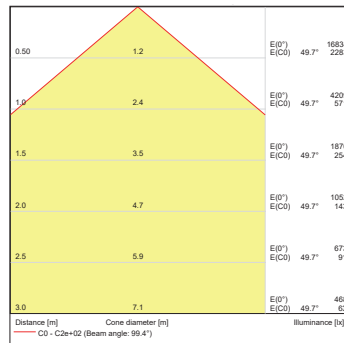
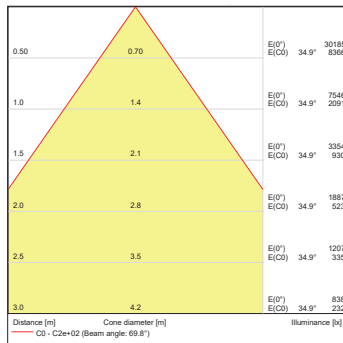
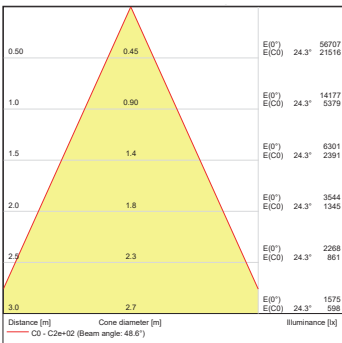
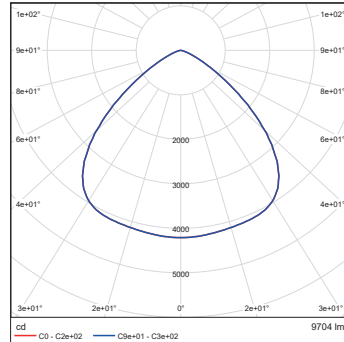

PHOTOMETRIC DATA

Calumma XL SC RGBW 6500K
10x30dg

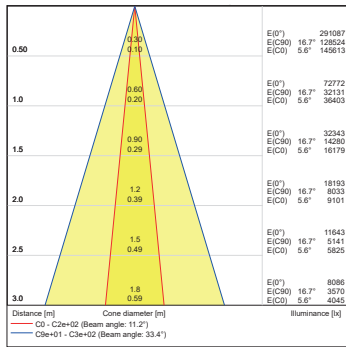
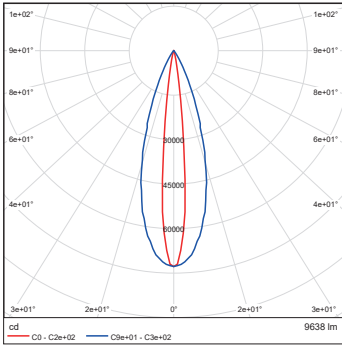

Calumma XL SC RGBW 6500K
10x60dg

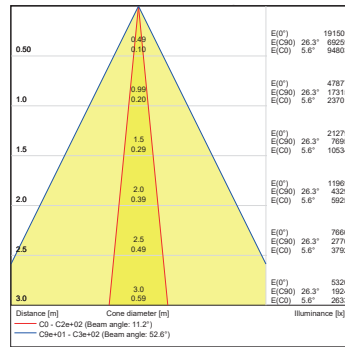
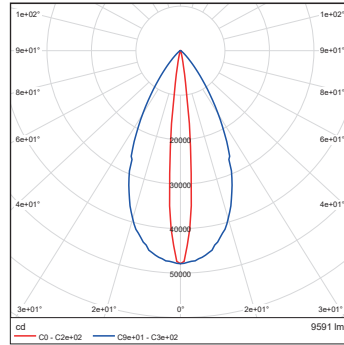

Calumma XL SC RGBW 6500K
15x45dg

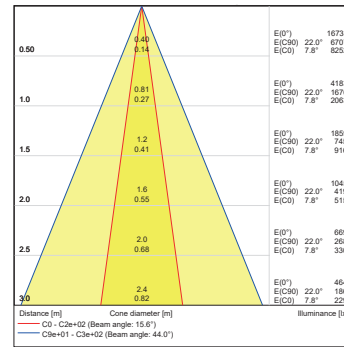
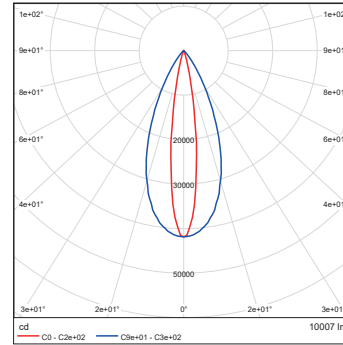

Calumma XL SC RGBW 6500K
15x90dg

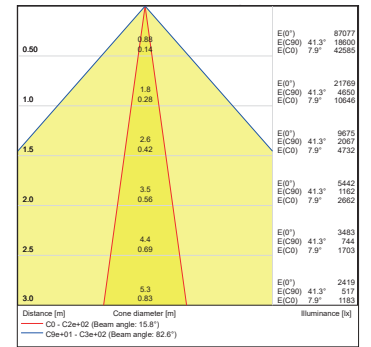
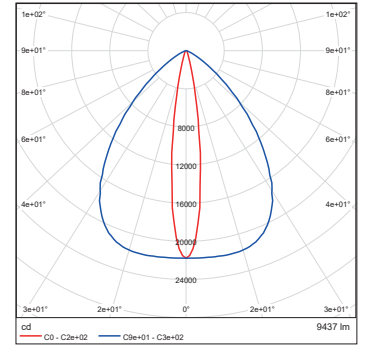

Calumma XL SC RGBW 6500K
30x60dg

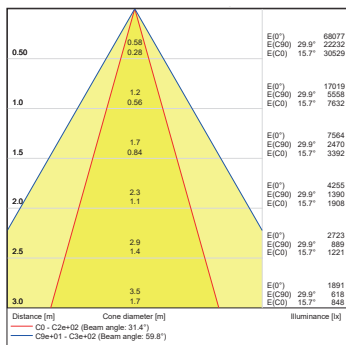
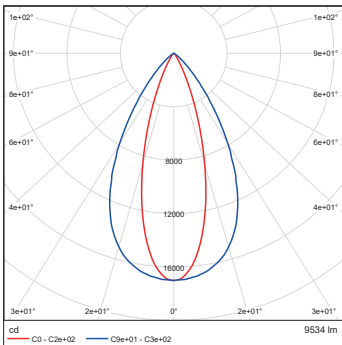

Calumma XL SC RGBW 6500K
30x90dg

