

# AMBIANE® SP16 RECESSED TILT

The smallest luminaire of Ambiane range offers efficient, powerful and high-quality solution for lower ceiling recessed applications. Highly efficient LED module with CRI 90+, no UV or IR emissions, CCT and green correction settings is perfect for museums, art galleries, theaters, concert halls and other most demanding installations. Sharing the same LED chip-set with other Ambiane fixtures it complements the range and gives lighting designers even more options for various interior lighting installations. Tiltable trim 0 - 25°.



## KEY FEATURES

### Lumen output & Light source

Available in wide range of colour configurations (RGBW, PW, TW, TD), the Ambiane SP16 Recessed utilises highly efficient LED modules with CRI 90+. The fixture offers two different beam spreads of 30° and 60°.

### Control

Using DALI or USITT DMX512 control protocols, with RDM support, Ambiane SP16 Recessed can be remotely controlled and managed. Ambiane SP16 Recessed also offers intelligent power balancing.

### Installation

With compact dimensions and ability to tilt within range of 0-25°, Ambiane SP16 Recessed is suitable for lower ceiling applications and to complement the standard Ambiane SP16 Recessed as well as our more powerful luminaires of Ambiane range. Ambiane SP16 Recessed Tilt is convection cooled for silent operation without fans.

## COLOURS

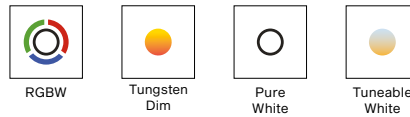

## COLOUR TEMPERATURE

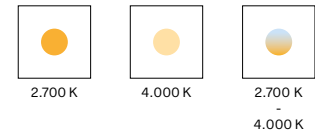

## CONTROL & PROTOCOLS



## OPTIC OPTIONS

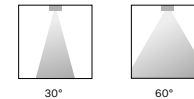

## STANDARD & SPECIFICATION

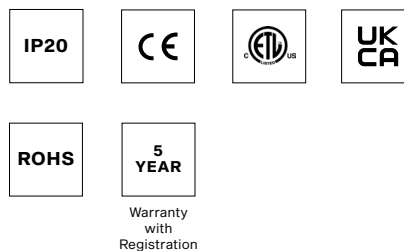

## FINISH OPTIONS

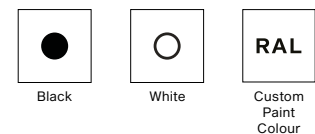

**SPECIFICATION**

<b>ELECTRICAL</b>	Input Voltage	48 V DC			
	Input Voltage range	44-50 V DC			
	Max. Power Consumption	10 W			
<b>OPTICAL</b>	Light Source	High Power LED module			
	Colour Variants	RGBW (W 2700 K or 4000 K)	Pure White	Tunable White	Tungsten Dim
	Colour Temperature of White	PW 2700 K or 4000 K   TW 2700-4000 K   TD 3200 K			
	CRI	90+			
	Beam Angle	30°   60°			
	Lumen Output Delivered	481 lm (RGBW at 30° White LEDs only)			
		518 lm (RGBW at 60° White LEDs only)			
Projected Lumen Maintenance	L90B10 >90.000 hrs, Ta = 25°C / 77°F				
<b>CONTROL</b>	Interface Protocol	USITT DMX512, RDM, DALI 2, 0-10 V			
	DALI 2 Device Type	DT 8			
	Control System	ArcControl Range or any Third Party Controller			
	DMX Modes	5 (for RGBW version)			
	DMX Channels	4, 3, 12, 3, 6			
	Settings / Addressing	DIP Switch, RDM			
	Power Supply	Ambiance Power AP (up to 4x Ambiance SP16)			
Ambiance Power Rack (up to 4x Ambiance SP16 per Output)					
<b>PHYSICAL</b>	Diameter x Height	Ambiance SP16 Recessed Tilt 30° - ø140 x 110 mm (ø5.5 x 4.3 in.)			
		Ambiance SP16 Recessed Tilt 60° - ø140 x 100 mm (ø5.5 x 3.9 in.)			
	Weight	0.69 kg   1.5 lbs			
	Housing	Die-Cast Aluminium Body			
	Trim Finish Options	Standard Color - White RAL9016   Black RAL9005			
		Cost Option - Custom RAL			
	Cables / Connections	Terminal block (Power In, DMX In/Out, DALI In/Out)			
	Mounting Method	Recessed, Via Spring Clips. Cut-Out Diameter: 115 mm / 4.5 in			
	Adjustability	0 - 25°			
	Protection Factor	IP20 / Dry location only			
	Cooling System	Convection			
	Operating Ambient Temperature	-20 °C / +40 °C (-4 °F / +104 °F) (TBC)			
	Max. Operating Temperature	+75°C (167°F) (TBC)			
<b>CERTIFICATION</b>	Listings	ETL / cETL, RoHS, CE, UKCA			
<b>ACCESSORIES</b>	<b>Included Items</b>	Control Unit for Ambiance SP16			
	<b>Not Included Items</b>	Ambiance Power Rack (CE/US)			
		Ambiance Power AP			

**DIAMETER OF CONDUCTORS**

Recommended diameters of conductors with respect to distance between Fixture and Power supply (per 4pcs of Ambiance SP16)

<b>Distance / Cable length</b>	100 m
<b>Diameters of conductors</b>	1 mm <sup>2</sup>

**DIMENSIONS**

Ambiane SP16 Recessed Tilt

30° H = 110 mm [4 3/8" inch]  
 60° H = 100 mm [3 15/16" inch]

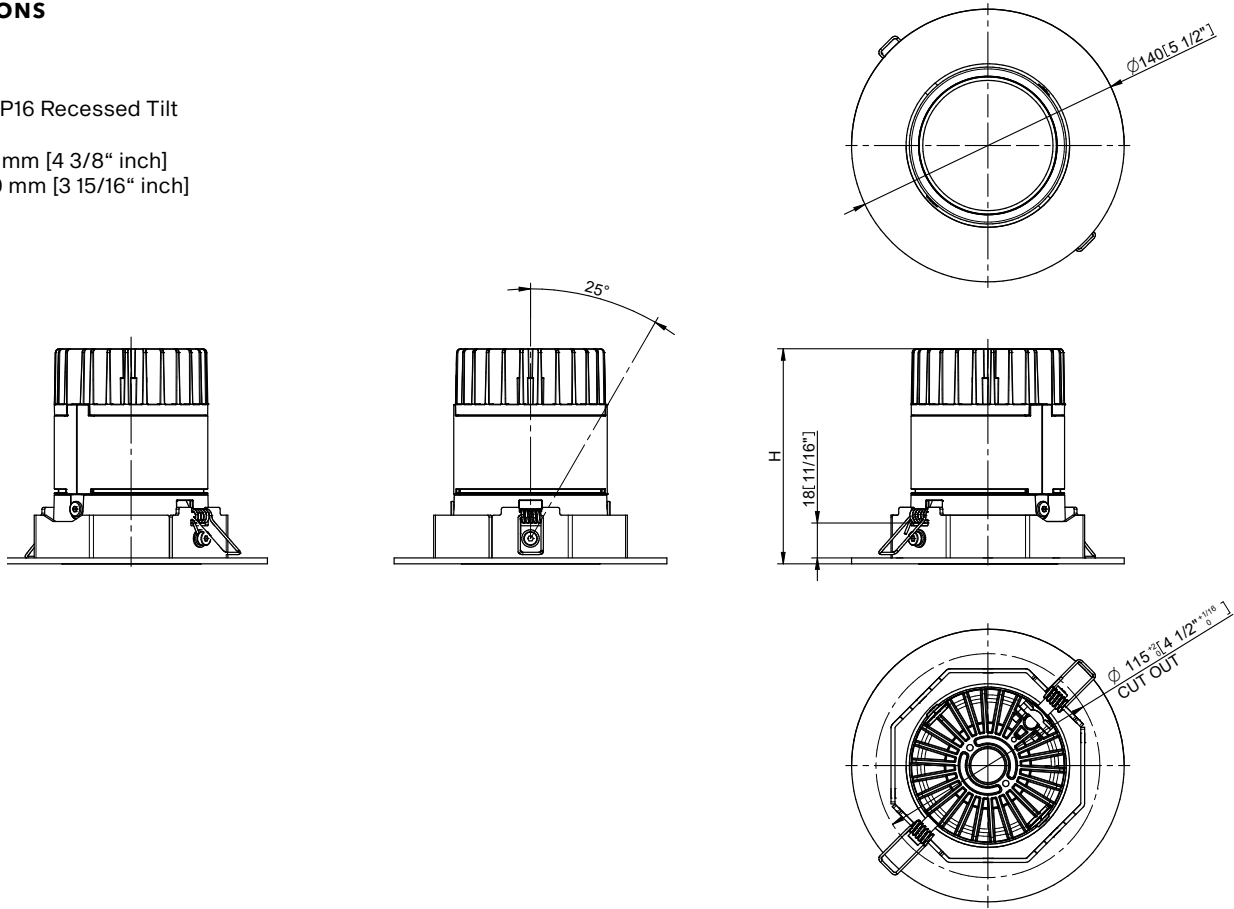

Ambiane SP16 w/Control Unit

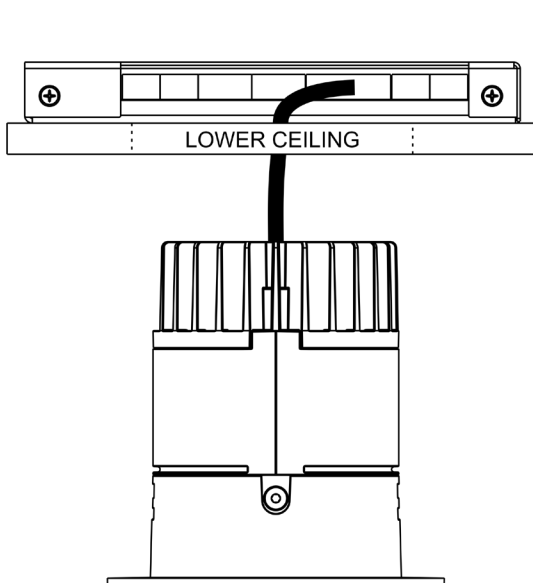

Control Unit dimensions

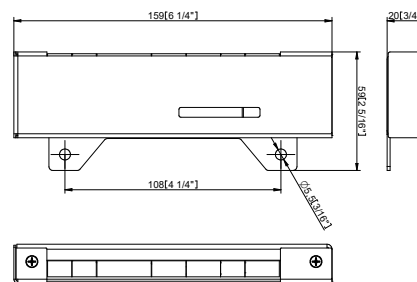

Quad Control Unit dimensions (CE Only)

- to be ordered as a bundle of 4 identical Ambiane SP16 fixtures and one Quad Control Unit.

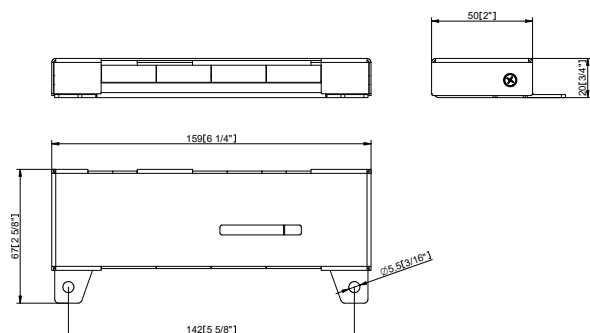

PHOTOMETRIC OVERVIEW

		Lumen Output (lm)			
		TILT 0°	TILT 10°	TILT 20°	TILT 25°
RGBNW (4000 K) WHITE LEDS ONLY	30°	481	518	520	517
	60°	518	481	475	470
RGBWW (2700 K) WHITE LEDS ONLY	30°	358	386	387	385
	60°	386	358	354	350
PW (4000 K)	30°	618	665	668	664
	60°	665	618	610	604
PW (2700 K)	30°	493	531	533	530
	60°	531	493	487	482
TW (2700 - 4000 K)	30°	358 - 481	386 - 518	387 - 520	385 - 517
	60°	386 - 518	385 - 481	354 - 475	350 - 470
TD (3200 - 2700 K)	30°	484 - 445	522 - 480	523 - 481	521 - 478
	60°	522 - 480	484 - 445	479 - 440	473 - 435

PHOTOMETRIC DATA

Ambiane SP16 Recessed  
 RGBNW 30dg White LEDS only  
 0dg Tilt

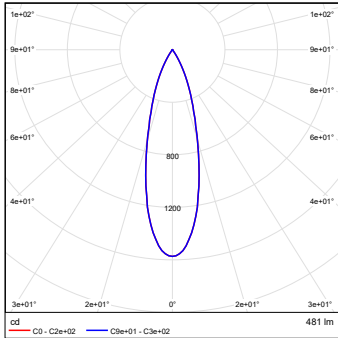

Ambiane SP16 Recessed  
 RGBNW 30dg White LEDS only  
 10dg Tilt

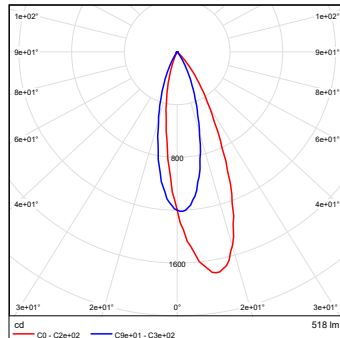

Ambiane SP16 Recessed  
 RGBNW 30dg White LEDS only  
 20dg Tilt

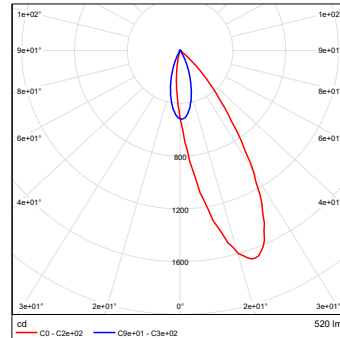

Ambiane SP16 Recessed  
 RGBNW 30dg White LEDS only  
 25dg Tilt

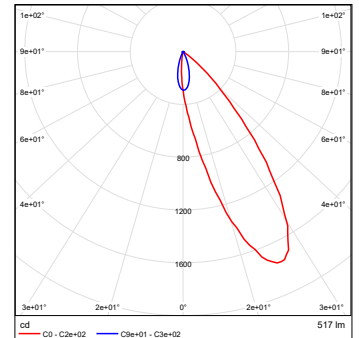

Ambiane SP16 Recessed  
 RGBNW 60dg White LEDS only  
 0dg Tilt

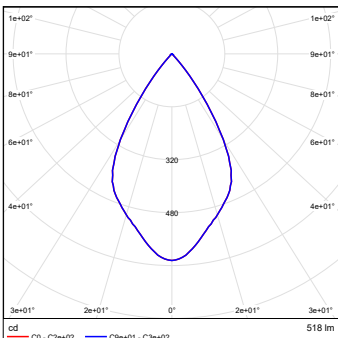

Ambiane SP16 Recessed  
 RGBNW 60dg White LEDS only  
 10dg Tilt

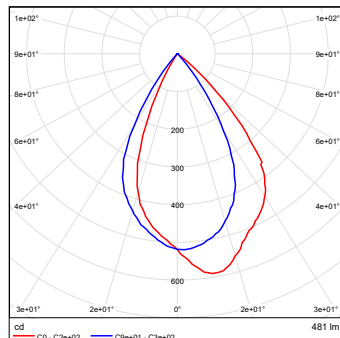

Ambiane SP16 Recessed  
 RGBNW 60dg White LEDS only  
 20dg Tilt

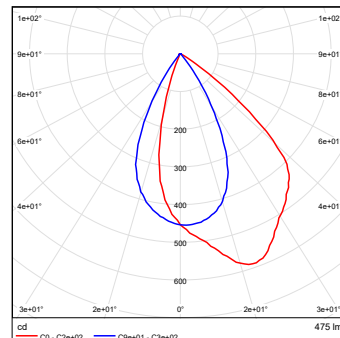

Ambiane SP16 Recessed  
 RGBNW 60dg White LEDS only  
 25dg Tilt

