

EMINERE® SIDE 1 / 2 / 3 / 4

Eminere Side is specifically designed for applications where a low form factor is required whilst keeping installation of the luminaire neat and clean. With only 76 mm in height, it keeps all of the Eminere series strengths. Wide range of optics options, durability, connectivity, application flexibility make this luminaire ideal solution for flood lighting, wall grazing, wall washing and accent lighting.



KEY FEATURES

Quick and Easy Installation

Easy and quick installation using click-on connectors overmolded on combo cable (Power + Data).

Durability

High durability of IK06 in combination of ingress factor IP67.

Application Flexibility

Complete solution for illuminating buildings, monuments, walls, statues, bridges, covers, arches and much more. With PSU on its side, Eminere Side is only 76 mm in height.

Optics & Colours

Wide range of optics allows to place product anywhere needed with no limitation. Full spectral LEDs selection with custom option on request. Output up to 1.147 lm (RGBW) or 1.652 lm (PW) per one foot of Eminere.

COLOURS



RGBW



RGBA



Pure White



Tuneable White

CONTROL & PROTOCOLS



OPTIONAL



OPTIONAL

COLOUR TEMPERATURE



2.200 K *



2.500 K *



2.700 K *



3.000 K



3.500 K *



4.000 K *



5.000 K *



6.500 K *



2.700 K
-
6.500 K *

* UPON REQUEST

STANDARD & SPECIFICATION



IP67



IK06



CE



ETL



ROHS



UK CA



5 YEAR

Warranty with Registration



Vibration Standard for Bridge

FINISH OPTIONS



Graphite Black



Silver



RAL
Custom Paint Colour



Harsh Environment

OPTIC OPTIONS

SYMMETRICAL



9°



15°



30°



50°



65°



100°

BI-SYMMETRICAL



10°x30°



10°x60°



15°x90°



35°x70°



30°x10°



60°x10°



90°x15°



70°x35°

ASYMMETRICAL



WIDE WALLWASHER



WALLWASHER

EMINERE SIDE SPECIFICATION

ELECTRICAL	Input Voltage	120 - 277 V AC 50/60 Hz			
	Typical Power Consumption	Eminere Side 1 / 2 / 3 / 4		25 W / 45W / 65W / 85W	
OPTICAL	Light Source	Eminere Side 1 / 2 / 3 / 4		12, 24, 36, 48 x High Power Single Chip LEDs	
	Colour Variants	RGBW (W - 6.500 K)		RGBA	
		PW (W - 3.000 K)			
	Variants On Request (TW (2700 - 6500 K), 2.200 K 2.500 K 2.700 K 3.500 K 4.000 K 5.000 K 6.500 K)				
	Beam Angle	Symmetrical:	9° 15° 30° 50° 65° 100°		
		Bi-symmetrical:	10° x 30° 30° x 10° 10° x 60° 60° x 10° 35° x 70° 70° x 35° 15° x 90° 90° x 15°		
		Asymmetrical:	Wallwasher Wide Wallwasher		
Lumen Output Delivered	Eminere Side 1: 1.147 lm, RGBW @ 9°		Eminere Side 3: 3.441 lm, RGBW @ 9°		
	Eminere Side 2: 2.294 lm, RGBW @ 9°		Eminere Side 4: 4.588 lm, RGBW @ 9°		
Projected Lumen Maintenance	L90B10 >90.000 hrs, Ta = 25°C / 77°F				
CONTROL	Interface Protocol	Via E-Box range or Wireless DMX (excluded Eminere Side 1)			
	E-Box Control Protocols	USITT DMX512, RDM, ArtNet, MA Net, MA Net2, sACN, Kling-Net			
	Wireless DMX (Option)	Lumen Radio CRMX Technology			
	Operating Modes	Pixel (12 LEDs/300mm) or Fixture mode			
	Setting / Addressing	Via Two Row LCD Display with Control Buttons or RDM communicator			
	Power Supply	Integrated			
	Connectivity	E-box Lite	144 of Eminere Side 1 (@ 230 V and 40m cable) via 1 Output		
		E-box Daisy	144 of Eminere Side 1 (@ 230 V and 40m cable) via 1 Output		
E-box Star		144 of Eminere Side 1 (@ 230 V and 40m cable) via 6 Outputs			
PHYSICAL	Width x Height x Length	Eminere Side 1 / 2 / 3 / 4		148 x 76 x 329 / 629 / 929 / 1229 mm 5.82 x 2.99 x 12.95 / 24.76 / 36.57 / 48.38 in.	
	Weight	2.95 kg / 6.5 lbs	4.75 kg / 10.47 lbs	7 kg / 15.43 lbs	
	Housing	High Pressure Extruded Aluminium Body End Caps - Die-Cast Aluminium Tempered Glass			
	Finish Options	Standard Colour	Graphite Black (RAL 9011) Silver (RAL 9006)		
		Cost Option	Custom RAL Harsh Environment (RAL 9016, RAL 9011)		
	Cables / Connections	IP67 Hybrid Connection (Power + Data)			
	Mounting Method	Surface Mount With Different Type of Brackets			
	Adjustability	-105° / +15°			
	Protection Factor	IP67 / Suitable For Wet Locations			
	IK Rating	IK06			
	Cooling System	Convection			
	Operating Ambient Temperature	-20 °C / +40 °C (-4 °F / +104 °F)			
Operating Temperature	+67 °C @ Ambient +40 °C (+153 °F @ Ambient +104 °F)				
CERTIFICATION	Listings	ETL / cETL, CE, RoHS, UKCA			
ACCESSORIES	Not Included Items				
	Mounting Brackets	Mounting Brackets 50 100 200 300 mm Custom length			
	Shields	Shield For Eminere Side 1 2 3 4			
	Cables and Connectors	Field Installable Connector FF	Field Installable Connector FM		
		Cable CE WCA	Cable US WCA		
		Waterproof Cover Cap FM ZAHB-0006			
		CE/UL Leader Cables FF for Eminere FF 2 5 10 25 50m			
CE/UL Jumper Cables FF/FM for Eminere FF/FM 0,25 0,5 1 2 3 5 10m					
Booster Box	Booster Box				

DIMENSIONS

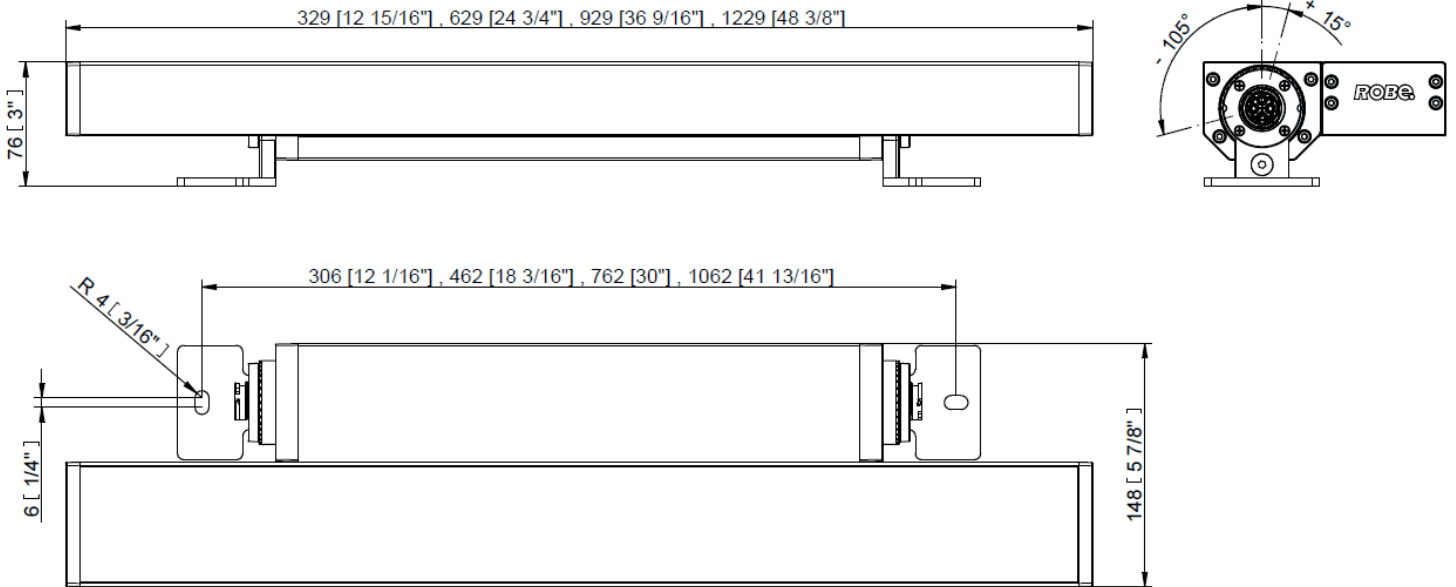

PROJECTED AREA

	Front (rear) - m ²	Front (rear) ft ²	Side - m ²	Side - ft ²	Top - m ²	Top - ft ²
Eminere Side 1 with Shield	0,024 0,041	0,258 0,441	0,007 -	0,075 -	0,050 0,051	0,538 0,549
Eminere Side 2 with Shield	0,041 0,074	0,441 0,796	0,007 -	0,075 -	0,084 0,085	0,904 0,914
Eminere Side 3 with Shield	0,063 0,111	0,678 1,194	0,007 -	0,075 -	0,129 0,131	1,388 1,409
Eminere Side 4 with Shield	0,115 0,150	0,925 1,614	0,007 -	0,075 -	0,173 0,175	1,861 1,883

PHOTOMETRIC OVERVIEW

Based on RGBW version, all leds @ full

Lumen Output (lm)

	EMINERE SIDE 1	EMINERE SIDE 2	EMINERE SIDE 3	EMINERE SIDE 4
9°	1147	2 294	3 441	4 588
15°	978	1 956	2 910	3 912
30°	1 046	2 092	3 138	4 184
50°	1 039	2 078	3 117	4 156
65°	1 040	2 080	3 120	4 160
100°	996	1 992	2 988	3 984
10° x 30°	1 032	2 064	3 096	4 128
10° x 60°	1 051	1 874	2 811	3 748
15° x 90°	970	1 940	2 934	3 880
35° x 70°	1 040	2 080	3 120	4 160
WallWasher	952	1 904	2 856	3 806
Wide WallWasher	854	1 708	2 562	3 416

BI-SYMMETRICAL BEAM ANGLES

Bi-symmetrical: 10°x30°, 10°x60°, 35°x70°, 15°x90°

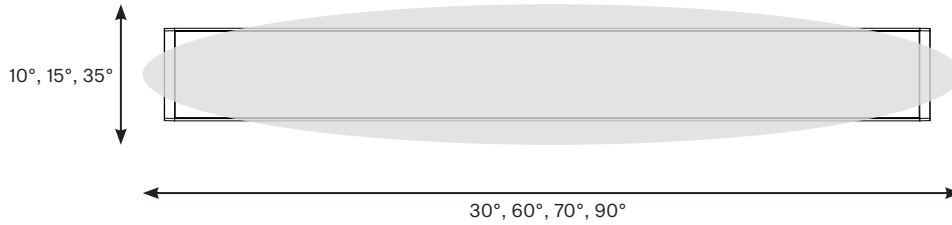

Bi-symmetrical: 30°x10°, 60°x10°, 70°x35°, 90°x15°

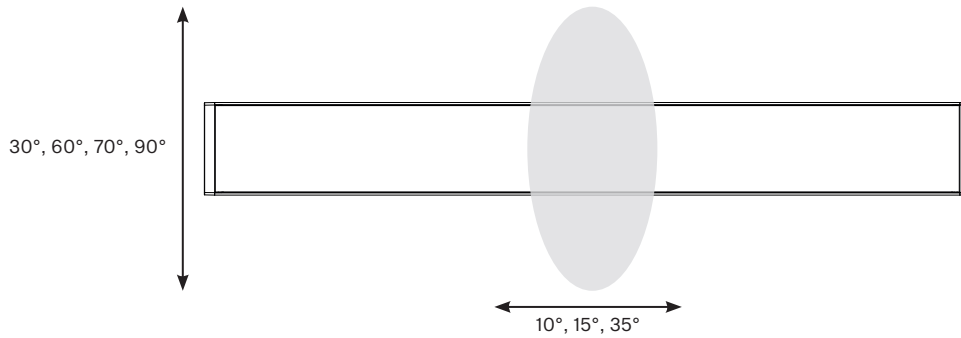

EMINERE SIDE INPUT OPTIONS

STANDARD

UPON REQUEST

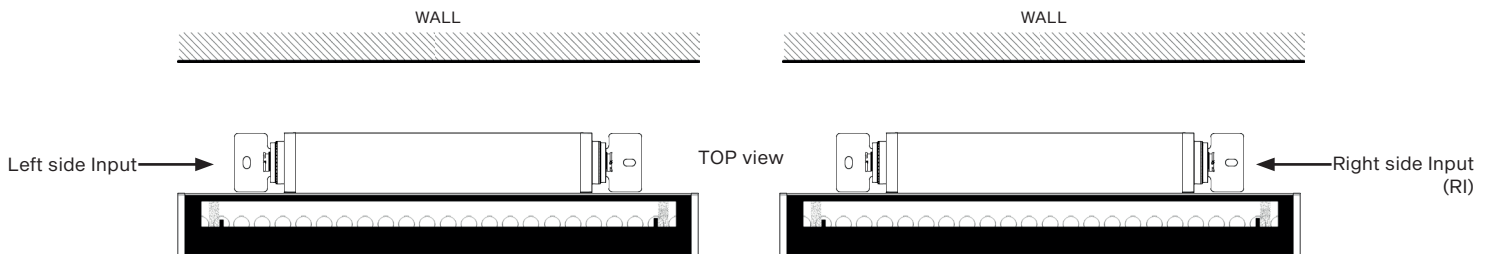

Note: Applies for all optic versions.

COLOUR MIXING PRINTS

STAND ALONE Specially designed glass printing to achieve optimal colour mixing and intensity distribution.

HEAD2HEAD Fixtures without special end glass print installed right next to each other create absolutely perfect colour and intensity overlap.

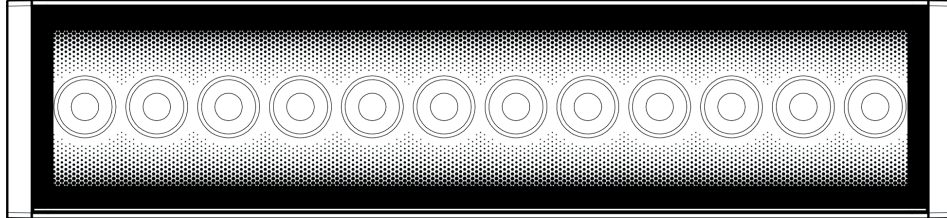

HEAD2HEAD

SYMMETRICAL

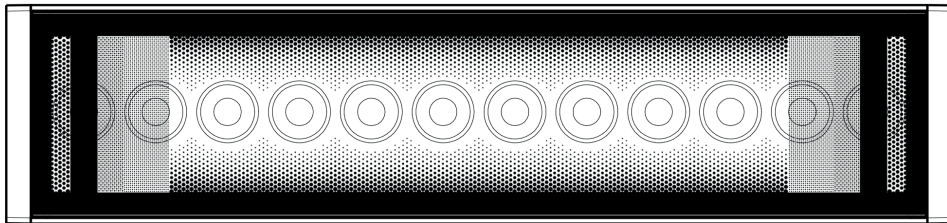

STAND ALONE

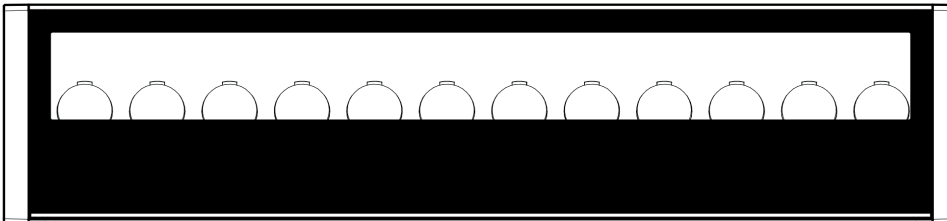

HEAD2HEAD

WALLWASHER

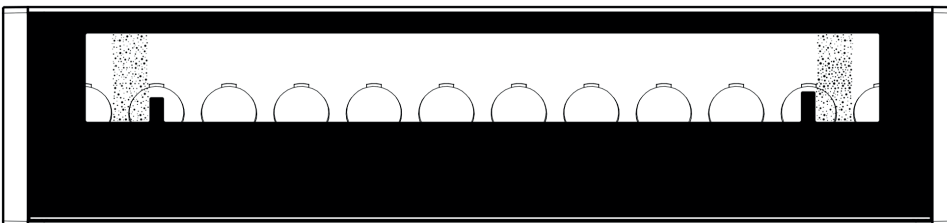

STAND ALONE

Note: Applies for RGBW, RGBA versions. Pure white and Tunable white versions are always without the end print (no matter on their position to other fixture).

E-BOX SPECIFICATION

ELECTRICAL	Input Voltage	120 – 277 V AC 50/60 Hz		
	Wireless DMX (Option)	Lumen Radio CRMX Technology		
	Interface Protocol	E-box Lite: USITT DMX512, RDM		
		E-box Daisy / Star: USITT DMX512, RDM, ArtNet, MA Net, MA Net2, sACN, Kling-Net		
Operating Modes	E-box Lite / Daisy: Fixture Mode, Pixel Mode, Output Mode			
	E-Box Star: Total Mode, Fixture Mode, Pixel Mode, Output Mode			
CONTROL	Display	Via Two Row LCD Display with Control Buttons or RDM communicator		
	Control System	E-box With Self Addressing Feature or Custom Setting Via LCD Display/RDM		
	Power Supply	Integrated		
	Connectivity	E-box Lite	144 of Eminere Side 1 (@ 230 V and 40m cable) via 1 Output	
		E-box Daisy	144 of Eminere Side 1 (@ 230 V and 40m cable) via 1 Output	
		E-box Star	144 of Eminere Side 1 (@ 230 V and 40m cable) via 6 Outputs	
	Length x Width x Height	E-box Lite	220 x 120 x 81 mm (8.66 x 4.72 x 3.18 in.)	
		E-box Daisy	260 x 160 x 91 mm (10.24 x 6.30 x 3.58 in.)	
		E-box Star	280 x 230 x 111 mm (11.02 x 9.06 x 4.37 in.)	
	Weight	1.67 kg 3.85 lbs	2.78 kg 6.13 lbs	4.4 kg 9.7 lbs
Housing	Die-Cast Aluminium Case			
Finish Options	Standard Colour - Graphite Black (RAL 9011) Silver (RAL 9006)			
	Cost Option - Custom RAL Harsh Environment (RAL 9016, RAL 9011)			
Cables / Connections	Cable Grommet (stainless steel)			
Mounting Method	Surface Mount , 4 Mounting Holes			
Protection Factor	IP67 / Suitable For Wet Locations			
IK Rating	IK10			
Cooling System	Convection			
Operating Ambient Temperature	-20 °C / +40 °C (-4 °F / +104 °F)			
CERTIFICATION	Listings	ETL / cETL, CE, RoHS, UKCA		

COMPARISON

	E-BOX LITE	E-BOX DAISY	E-BOX STAR
Power input	1	1	1
Fixture Output	1	1	6
Total load (current)	16A	16A	16A
DMX control	YES	YES	YES
RDM	YES	YES	YES
Art-Net	NO	YES	YES
Ethernet switch	NO	YES	YES
Kling-Net	NO	YES	YES
sACN	NO	YES	YES
MA Net, MA Net2	NO	YES	YES

E-BOX DIMENSIONS

E-BOX LITE

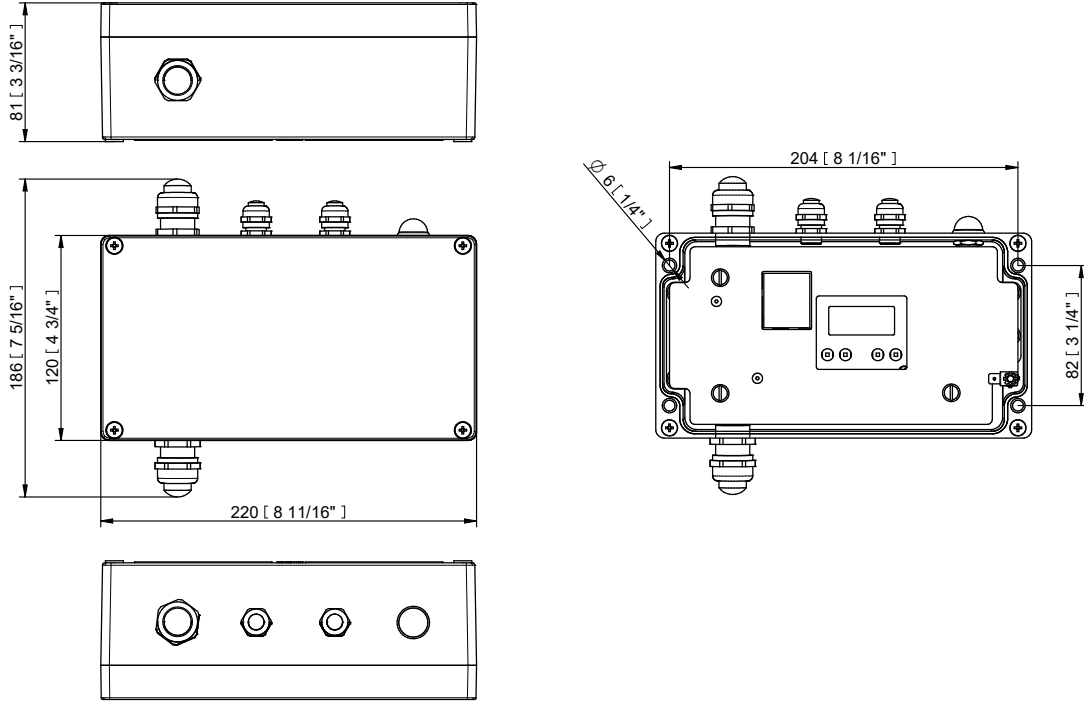

E-BOX DAISY

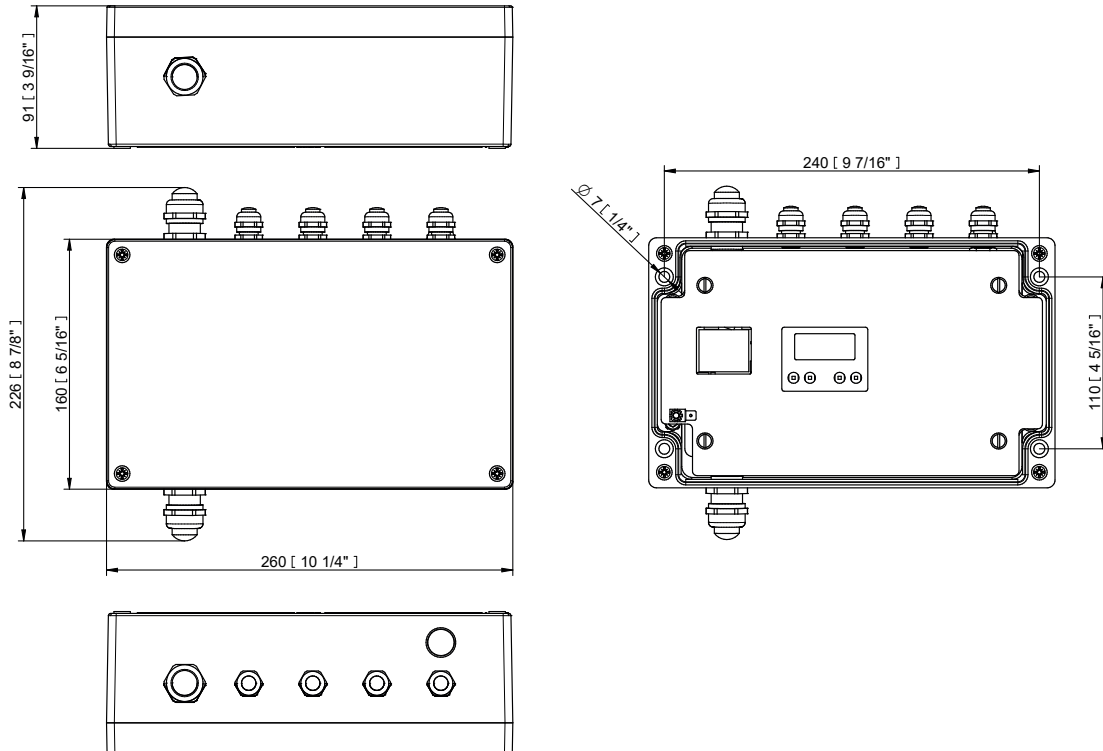

E-BOX STAR

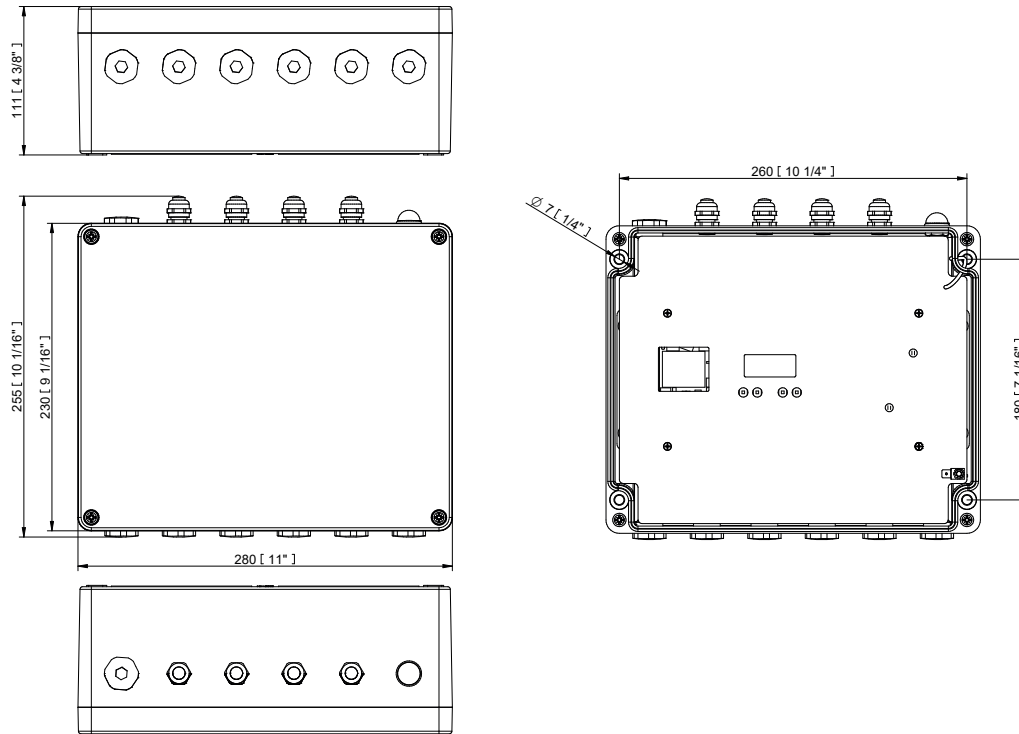

CONNECTIVITY

Following table shows maximum connected Emineres on each output of E-Box with respect of cable length.

	Cable length (m)	Voltage (V)						Cable length (m)	Voltage (V)				
		100	120	190	230	277			100	120	190	230	277
EMINERE 1	10	69	83	131	159	191	EMINERE 3	10	23	28	44	53	64
	20	61	83	131	159	191		20	20	28	44	53	64
	30	40	58	131	159	191		30	13	19	44	53	64
	50	24	35	88	128	186		50	8	12	29	43	62
	70	17	25	63	92	133		70	6	8	21	31	44
	100	12	17	44	64	93		100	4	6	15	21	31
	200	6	9	22	32	47		200	2	3	7	11	16
EMINERE 2	10	34	41	64	78	94	EMINERE 4	10	17	21	33	40	48
	20	30	41	64	78	94		20	15	21	33	40	48
	30	20	28	64	78	94		30	10	15	33	40	48
	50	12	17	43	63	91		50	6	9	22	32	47
	70	8	12	31	45	65		70	4	6	16	23	38
	100	6	9	21	31	46		100	3	4	11	16	23
	200	3	4	11	16	23		200	2	2	5	8	12

* Cable length is a total cable length between E-box and last connected Eminere. Example: Total cable length=L1+L2+L3

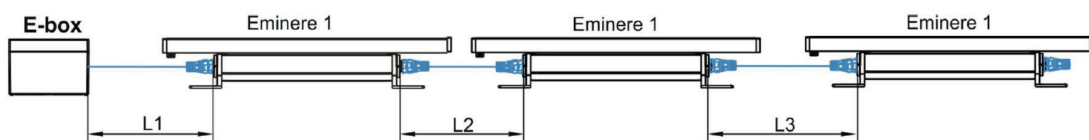

CONNECTION

E-BOX LITE / DAISY

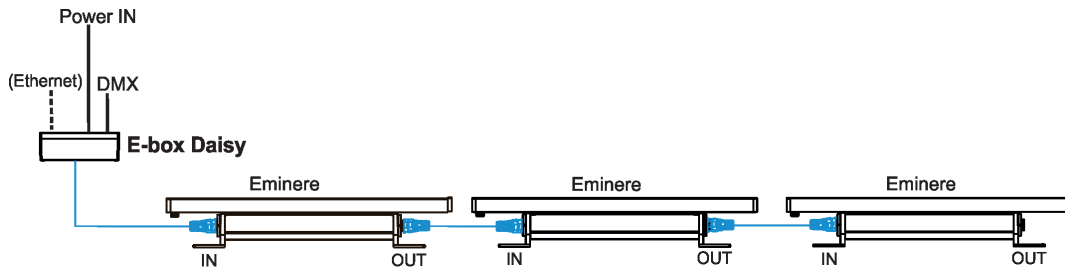

E-BOX STAR

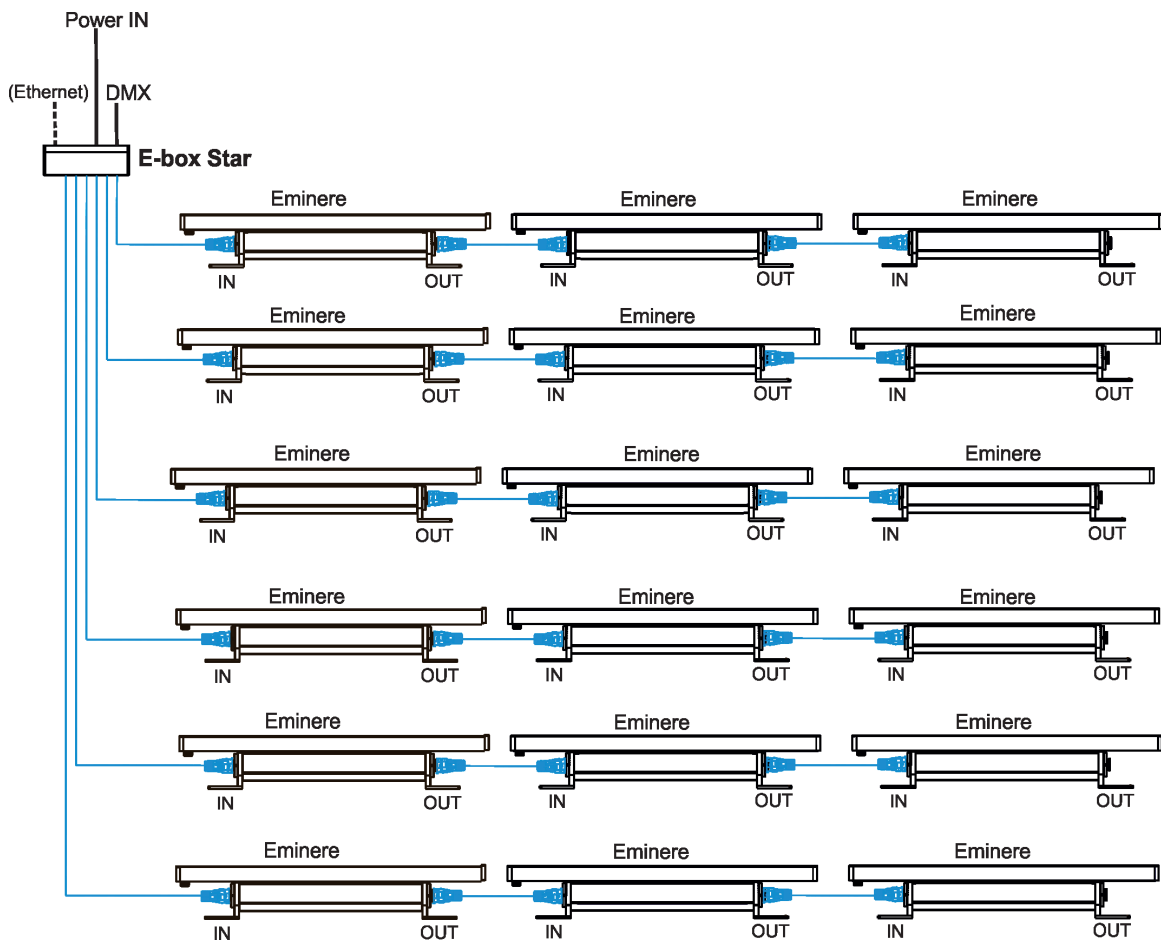

CONNECTION - WIRELESS VERSION

Connection setup, where every Eminere is independently accepting data from WIFI.



THE BOOSTER BOX

To compensate a voltage drop in a large installation, the Booster boxes have to be connected in the chain of Eminere modules.

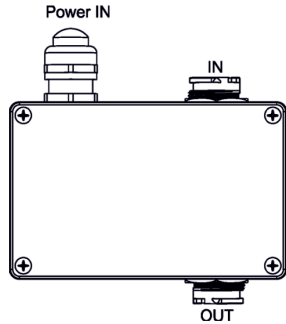

Example: E-box Daisy, Power supply= 230V, Cable length=70m, fixture=Eminere 2.
The Booster box has to be connected after every 45th Eminere 2 (fixture 45 and fixture 90) from 94 fixtures.

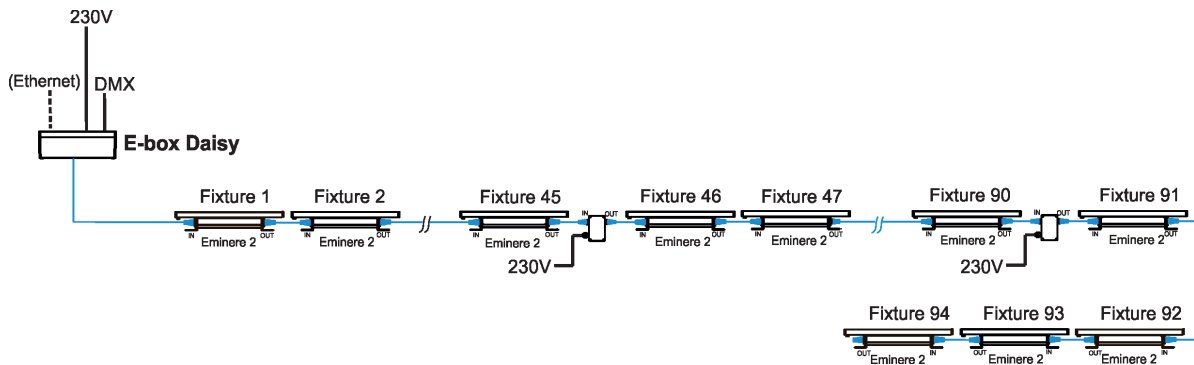

DIMENSIONS

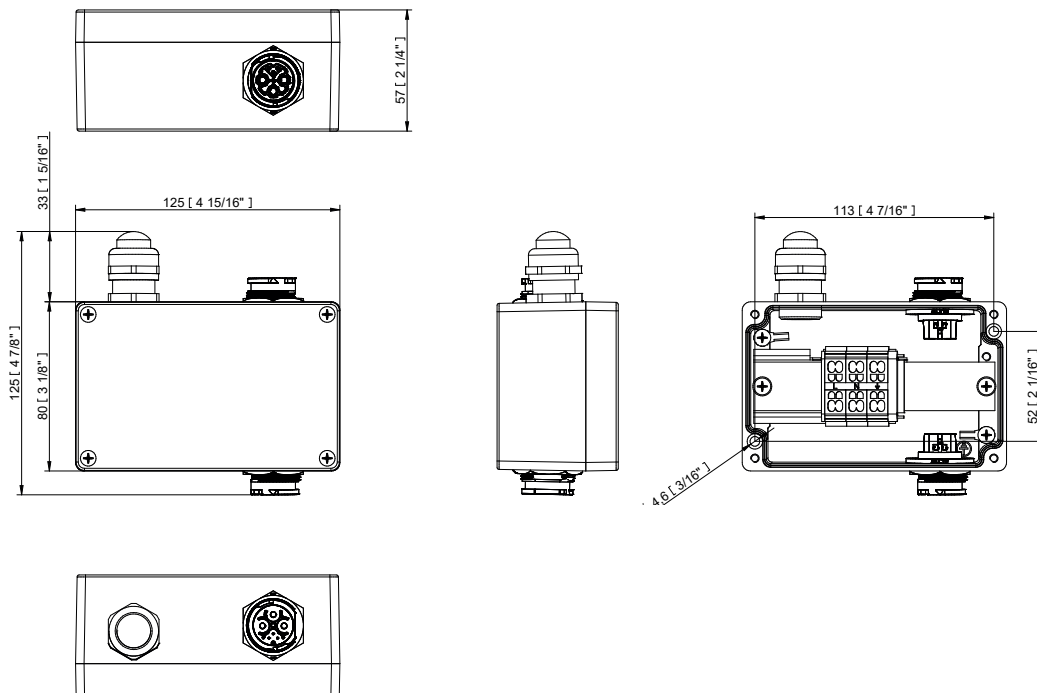

BOOSTER BOX POSITIONS

	Cable length (m)	Max. number of Emineres 1 = 191 (in Standard mode)			
		120 V	190 V	230 V	277 V
EMINERE 1	10 m	83,166	131	159	-
	20 m	83,166	131	159	-
	30 m	58,116,174	131	159	-
	50 m	35,70,105,140,175	88,176	128	186
	70 m	25,50,75,100,125,150,175	63,126,189	92,184	133
	100 m	17,34,51,68,85,102,119,136,153,170,187	44,88,132,176	64,128	93,186
	200 m	9,18,27,36,45,54,60,72,81,90,99,108,117,126,135,144, 153,162,171,180,189,	22,44,66,88,110,132,154,176	32,64,96,128,	47,94,141,188

NOTE: For more detail see the User manual.

ACCESSORIES

Shield for Eminere side

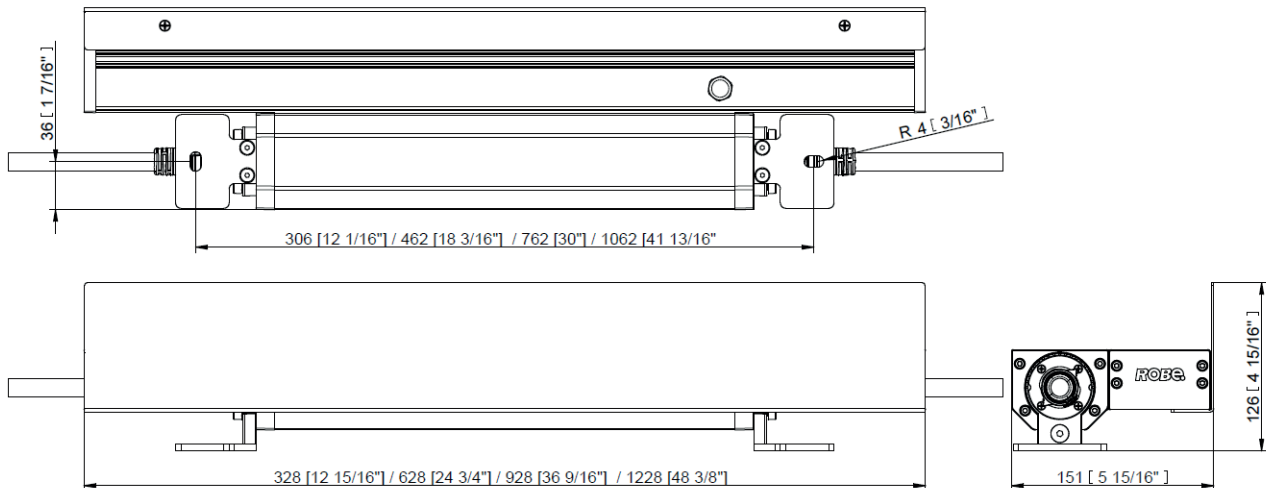

Mounting Brackets for Eminere Side

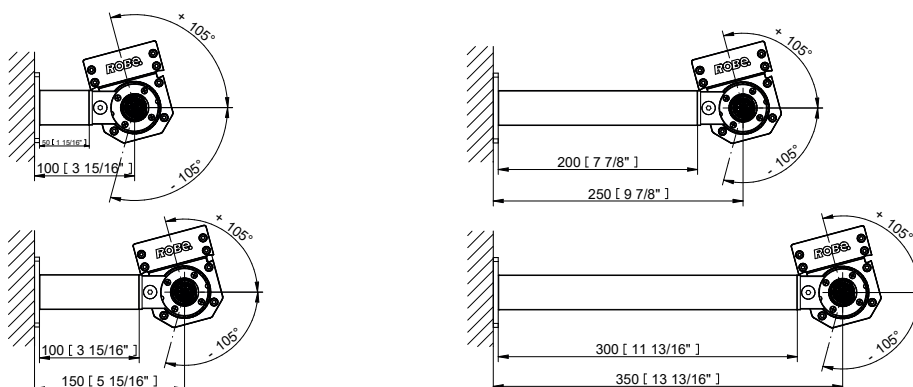

CABLES

Leader Cable

For connecting E-Box with first Eminere. Comes with Waterproof End Cap which has to be installed to the last Eminere's output connector.

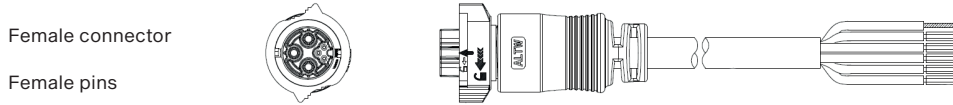

Female connector

Female pins

Jumper Cable

For connection between two Emineres.

NOTE: Custom length of Jumper cable depends on the distance between two Eminere luminaires (length includes cable and connectors).

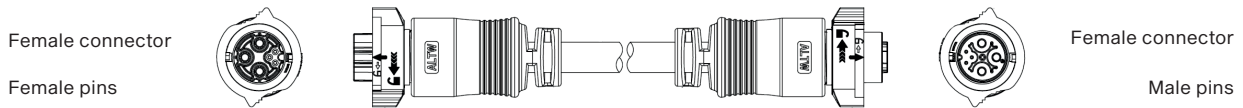

Female connector

Female pins

Female connector

Male pins

Field installable connector

For special cases, where Jumper Cable can't be used. Then use Leader Cable with Field installable connector to make a connection between Emineres.

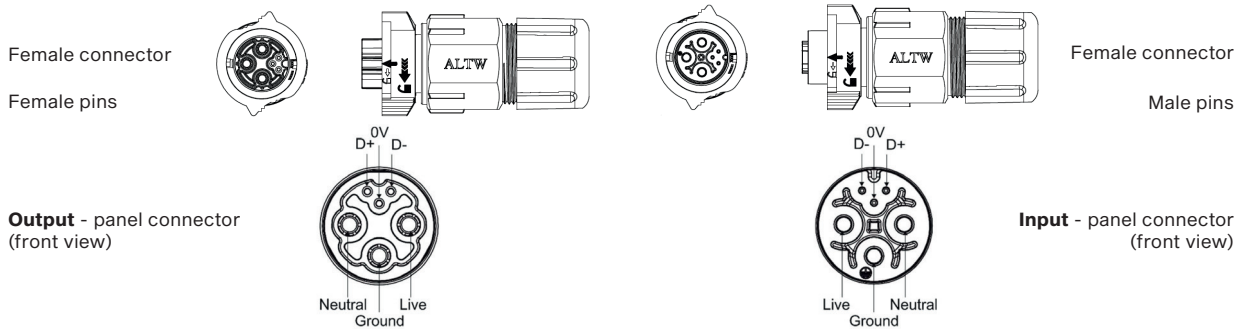

Female connector

Female pins

Female connector

Male pins

Output - panel connector
(front view)



Input - panel connector
(front view)



Waterproof End Cap

Install at the end of line to the last Emineres output connector.

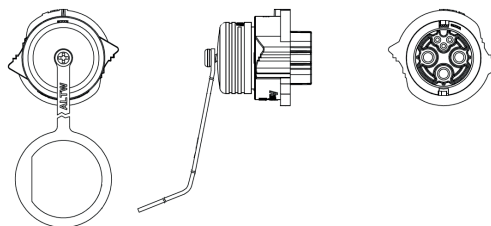

Cable lengths available

IN METRES	LEADER CABLE	JUMPER CABLE
0,25	-	YES
0,5	-	YES
1	-	YES
2	YES	YES
3	-	YES

IN METRES	LEADER CABLE	JUMPER CABLE
5	YES	YES
10	YES	YES
25	YES	-
50	YES	-
Other lengths	On Request	

PHOTOMETRIC DATA

Eminere Side 4 RGBCW 9dg

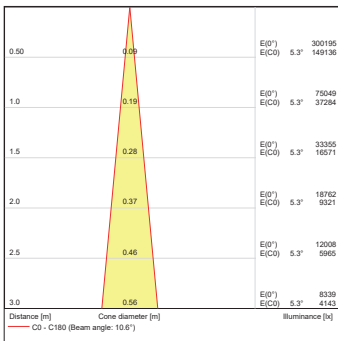
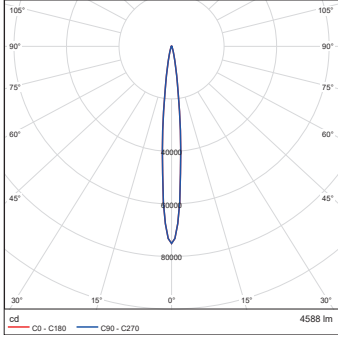

Eminere Side 4 RGBCW 15dg

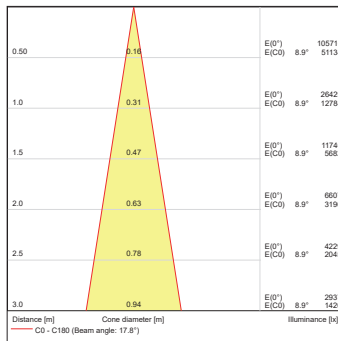
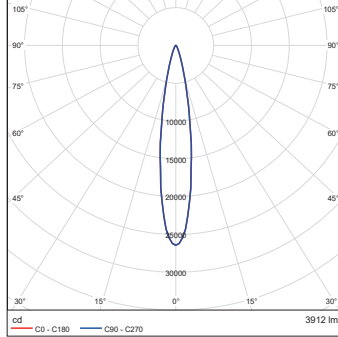

Eminere Side 4 RGBCW 30dg

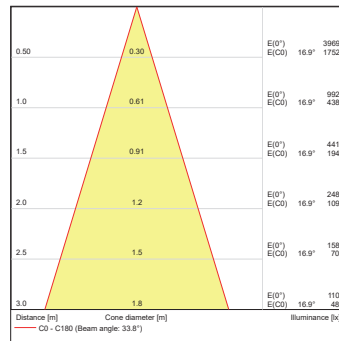
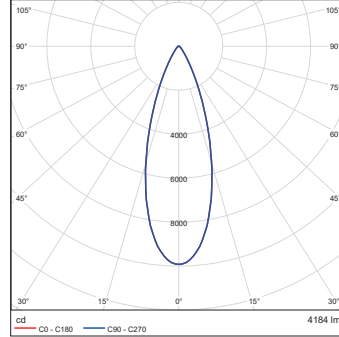

Eminere Side 4 RGBCW 50dg

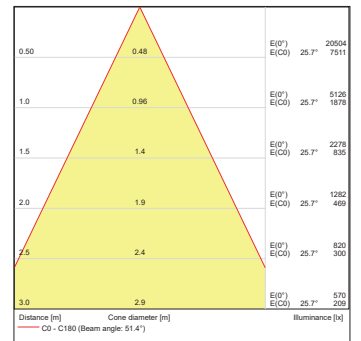
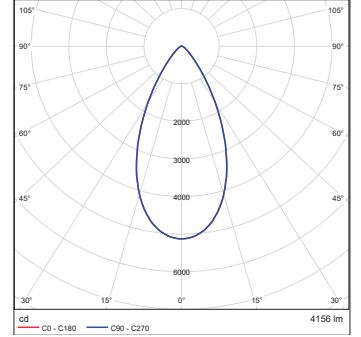

Eminere Side 4 RGBCW 65dg

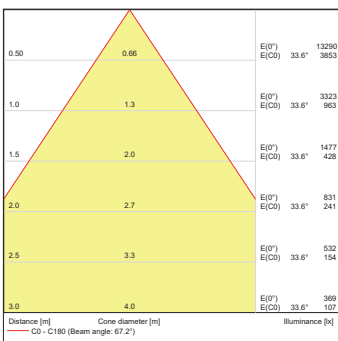
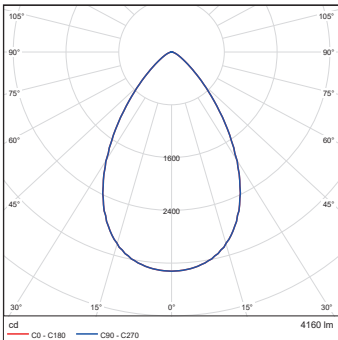

Eminere Side 4 RGBCW 100dg

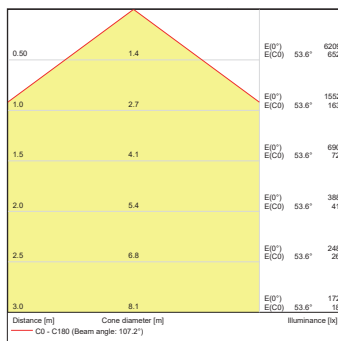
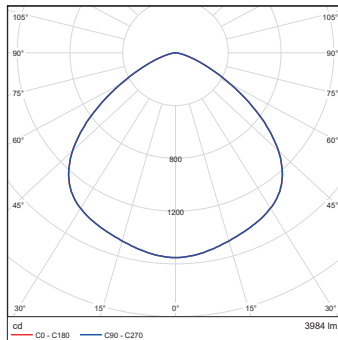

PHOTOMETRIC DATA

Eminere Side 4 RGBCW 10dg x 30 dg

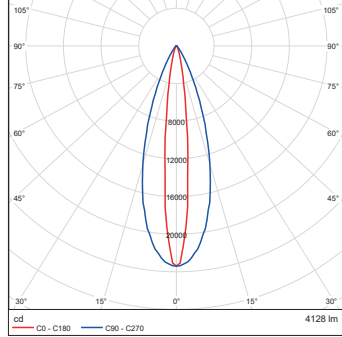

Eminere Side 4 RGBCW 10dg x 60 dg

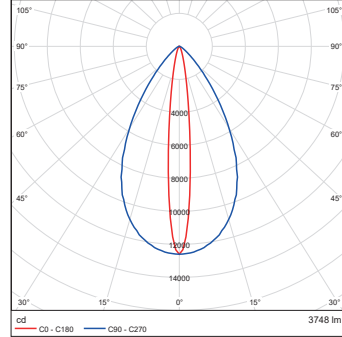

Eminere Side 4 RGBCW 35dg x 70dg

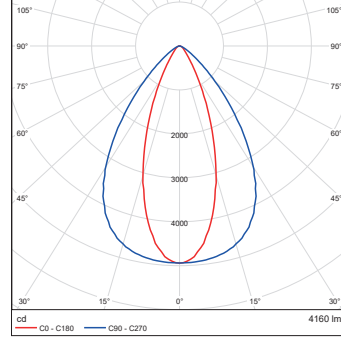

Eminere Side 4 RGBCW 15dg x 90dg

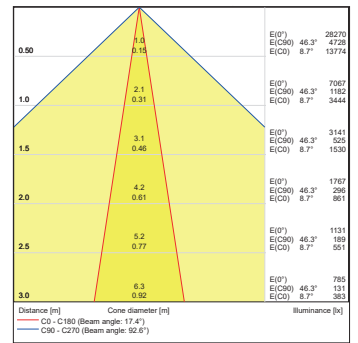
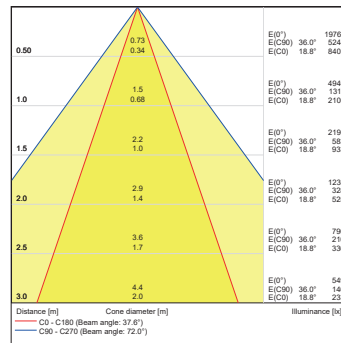
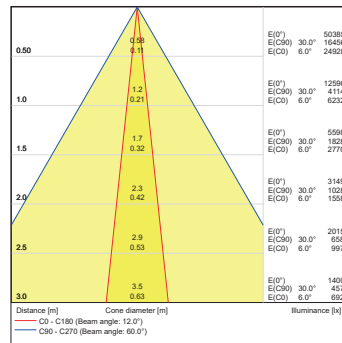
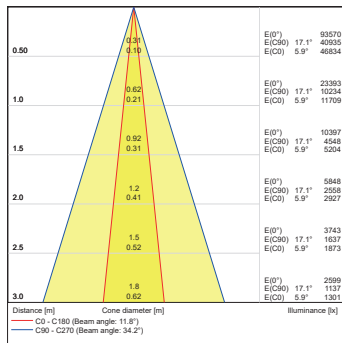
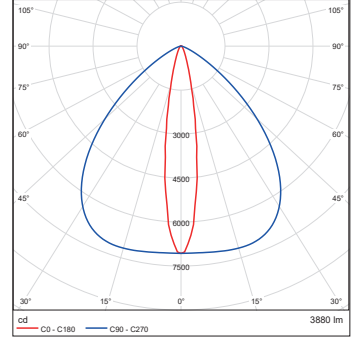

Eminere Side 4 RGBCW WallWasher

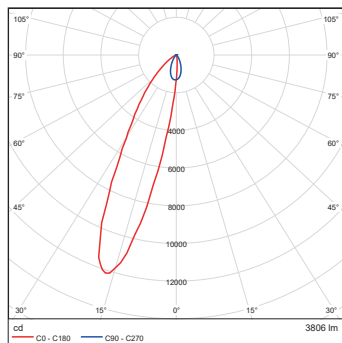

Eminere Side 4 RGBCW Wide WallWasher

