

DIVINE™ 72

The latest fixture in the Divine range, the Divine 72 features cutting-edge Zero Passive technology to eliminate light over-spill with our most precise optics to date. Specifically developed to optimise the beam for long throw applications, the native 6° beam angle delivers an impressive 6.573 lx at 10 meters. Backed by a 5 year warranty and an IP67 rating, this unit has been designed for the rigours of extreme weather, and with flexible mounting options and accessories it can be installed on the most demanding projects.



KEY FEATURES

Physical

Optimised for long throw applications, patented beam control technology eliminates light spill.

Lumen Output & Light Source

72 high power LEDs provide up to 10,228 lm flux when RGBW colour configuration and 6° optics are used.

Projected Lumen Maintenance

The long 90,000 hrs LED lifetime (L90B10) make Divine 72 an ideal choice for long-term lighting applications.

Power Consumption

Power consumption is only 325 W when operating at full power.

COLOURS



RGBW



RGBA



Pure
White

COLOUR TEMPERATURE



6.500 K *

* UPON REQUEST

CONTROL & PROTOCOLS



DMX
RDM



WIRELESS
DMX
OPTIONAL



0-10V

OPTIC OPTIONS

SYMMETRICAL



6°



10°



20°



30°



45°



60°



100°

BI-SYMMETRICAL



6°x30°



30°x6°



6°x60°



60°x6°



10°x40°



40°x10°



35°x70°



70°x35°



30°x90°



90°x30°



10°x90°



90°x10°

STANDARD & SPECIFICATION



IP67



IK10



CE



ETL
US



ROHS



UK
CA



2
YEAR
Warranty

FINISH OPTIONS



Graphite
Black



Silver



RAL
Custom
Paint
Colour

DIVINE 72 SPECIFICATION

ELECTRICAL	Input Voltage	100 - 277 V AC 50/60 Hz	
	Typical Power Consumption	325 W +/- 10 %	
	Inrush Current	30 A @ 230 V, 20 A @ 115V	
OPTICAL	Light Source	72 x High Power Single Chip LEDs	
	Colour Variants	RGBW (W - 6500 K)	PW (6500 K) Upon Request
	Beam Angle	Symmetrical: 6° 10° 20° 30° 45° 60° 100° Bi-symmetrical: 6° x 30° 30° x 6° 6° x 60° 60° x 6° 10° x 40° 40° x 10° 35° x 70° 70° x 35° 30° x 90° 90° x 30° 10° x 90° 90° x 10°	
	CRI	70+ (@RGBCW and PW 6500 K)	
	Peak Intensity	6.573 lx @ 10 m	
	Lumen Output Delivered	10.228 lm (RGBW 6°, all LEDs on full)	
	Projected Lumen Maintenance	L90B10 >90.000 hrs, Ta = 25°C / 77°F	
	CONTROL	Display	LED Display (Inside Integrated Junction Box)
Wireless DMX (Option)		Lumen Radio CRMX Technology	
Interface Protocol		USITT DMX512, RDM, 0-10 V (PW only)	
Control System		Third Party DMX Controllers	
Operating Modes		DMX, Stand-alone	
DMX Modes Channels		4 (for RGBW version) 10, 14, 5, 4	
Programs / Functions / Features		Editable Program: 1 (up to 40 steps)	
Settings / Addressing		Via LED Display with Control Buttons or RDM	
Power Supply		Integrated	
PHYSICAL		Width x Height x Depth	463 x 314 x 175 / 237 mm (18.2 x 12.4 x 6.9 / 9.3 in.)
	Weight	16.5 kg / 36.38 lbs	
	Housing	High Pressure Die-Cast Aluminium Body Tempered Glass	
	Finish Options	Standard Colour - Graphite Black (RAL 9011), Silver (RAL 9006)	Cost Option - Custom RAL
	Cables / Connections	Integrated Junction Box With Terminal Block Recommended: Li9Y11Y 3 x AWG16 + 1(2 x AWG24)	
	Mounting Method	Surface Mount, Flush (J-Box), C-Clamp (For Side Connection Only)	
	Adjustability	+35° / -150°	
	Protection Factor	IP67 / Suitable For Wet Locations	
	IK Rating	IK10	
	Cooling System	Convection	
	Operating Ambient Temperature	-20 °C / +40 °C (-4 °F / +104 °F)	
	Operating Temperature	+85°C @ Ambient + 25°C (+185°F @ Ambient + 77°F)	
	Total Heat Dissipation	1410 BTU/h (calculated)	
CERTIFICATION	Listings	ETL / cETL, CE, RoHS, UKCA	
ACCESSORIES	Included Items	Surface Mount Adaptor	
	Not Included Items	Optical Demo Set for Divine 72	
		Set of Rubber Feet	
		C-Clamp Adaptor Divine (for side conn. only)	
		Single Top Loader Case Divine	

DIMENSIONS

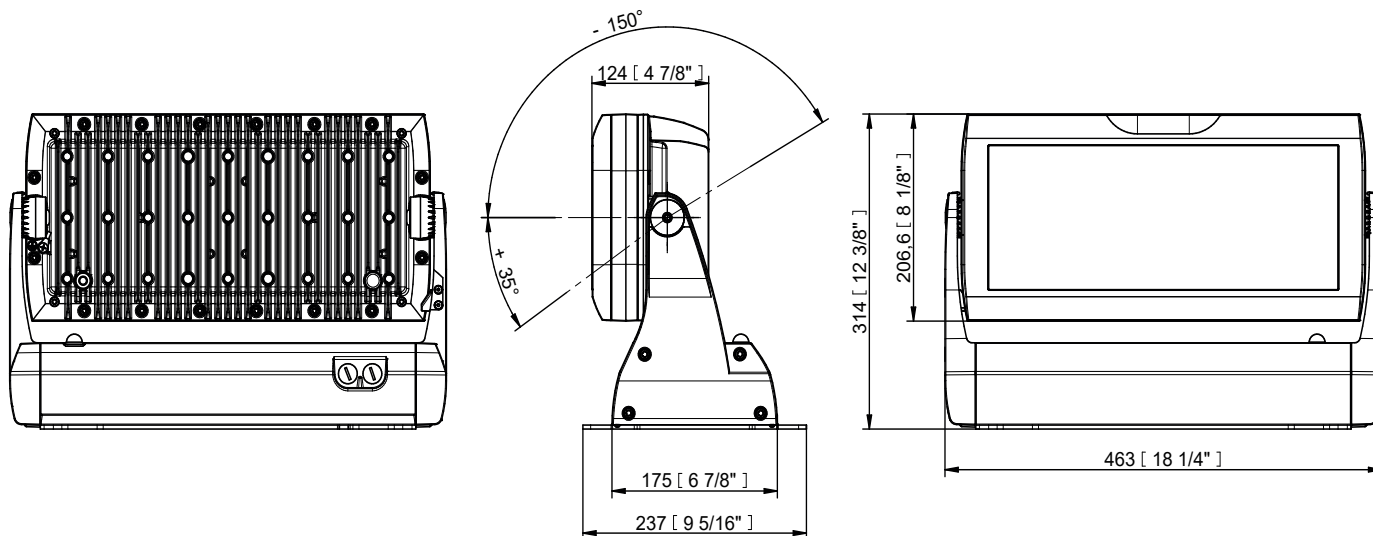

PROJECTED AREA

		m ²	ft ²
Divine 72	Front (rear)	0,13	1,40
	Side	0,04	0,39
	Top	0,09	0,95
Divine 72 with Top Hat	Front (rear)	0,13	1,40
	Side	0,0533	0,573
	Top	0,12	1,3
Divine 72 with Half Top Hat	Front (rear)	0,13	1,40
	Side	0,048	0,516
	Top	0,12	1,3

ACCESSORIES FOR DIVINE 72

Set of Rubber Feet



C-Clamp Adaptor Divine (for side conn. only)

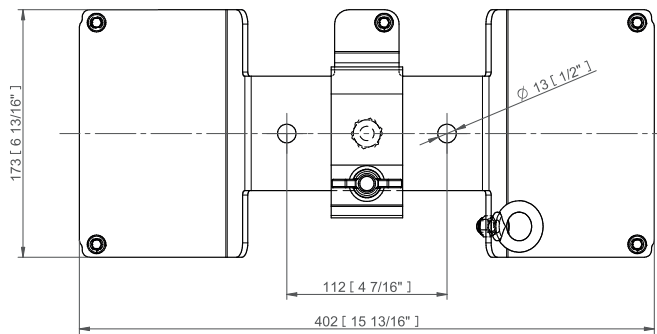
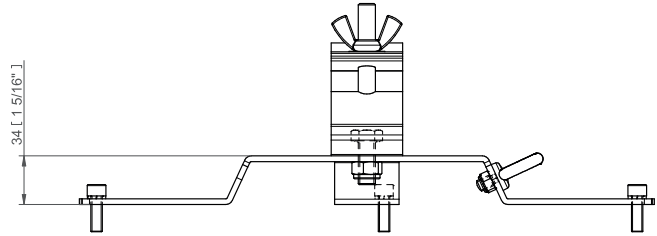
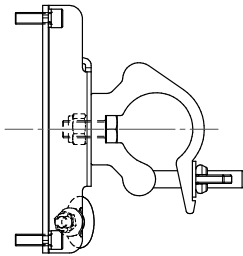
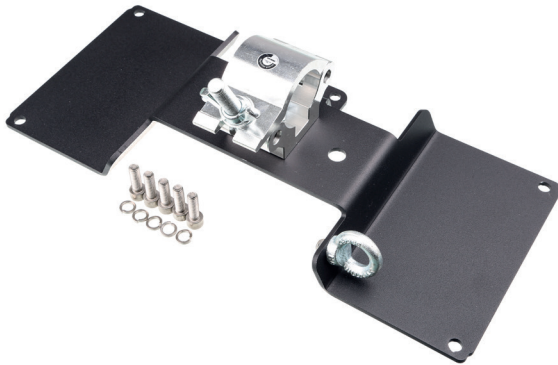

PHOTOMETRIC OVERVIEW

Lumen Output (lm)

	RGBW (6500 K)	PW (W 6500 K)
6°	10 228	20 441
10°	9 288	20 140
20°	8 603	18 654
30°	8 061	17 480
45°	8 539	18 516
60°	8 913	19 325
100°	8 638	18 731
6° x 30°, 30° x 6°	8 350	18 105
6° x 60°, 60° x 6°	7 837	16 994
10° x 40°, 40° x 10°	8 025	17 401
10° x 90°, 90° x 10°	7 199	15 610
30° x 90°, 90° x 30°	8 536	18 509
35° x 70°, 70° x 35°	8 758	18 991

BI-SYMMETRICAL BEAM ANGLES

Bi-symmetrical: 6°x30°, 6°x60°, 10°x40°, 10°x90°, 30°x90°, 35°x70°

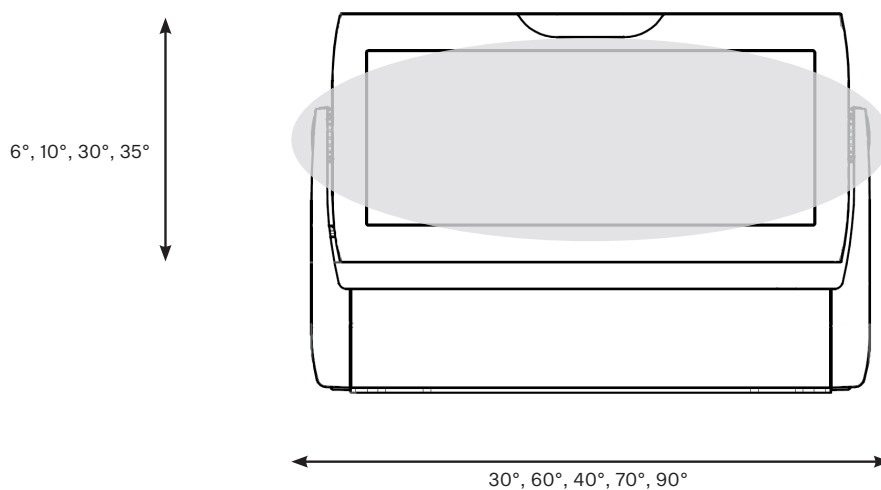

Bi-symmetrical: 30°x6°, 60°x6°, 40°x10°, 90°x10°, 90°x30°, 70°x35°

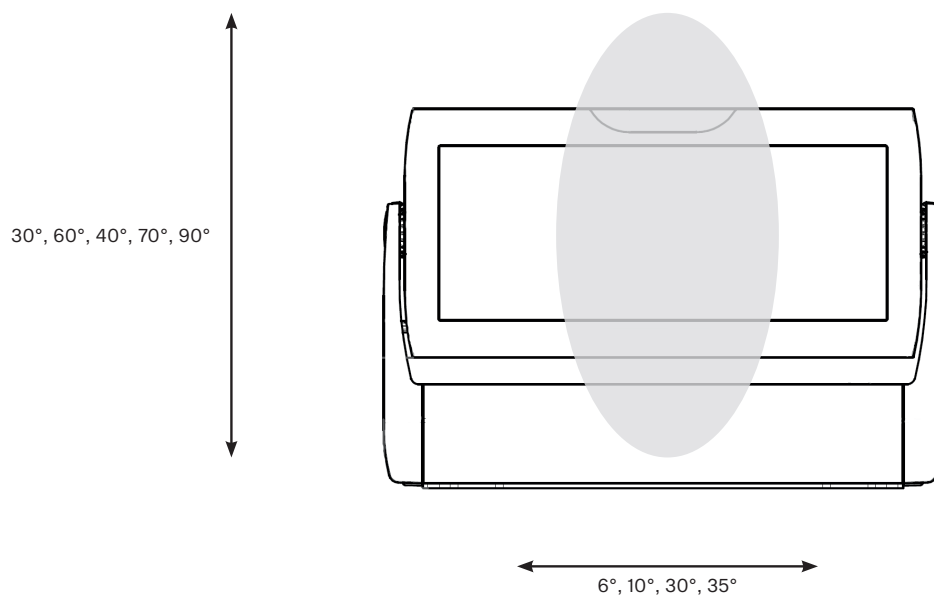

PHOTOMETRIC DATA

Divine 72 RGBCW 6dg

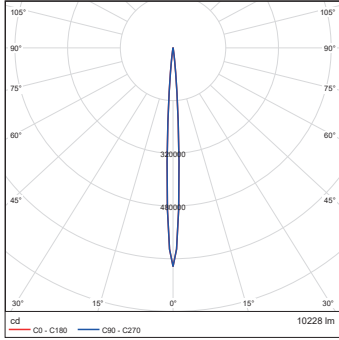

Divine 72 RGBCW 10dg

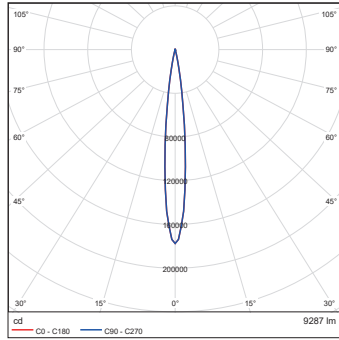

Divine 72 RGBCW 20dg

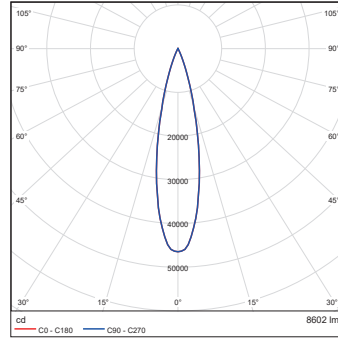

Divine 72 RGBCW 30dg

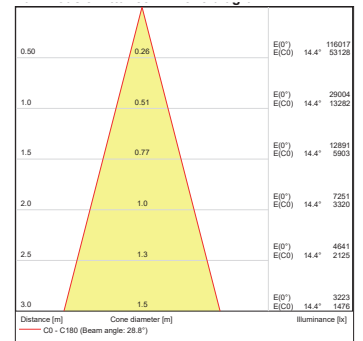
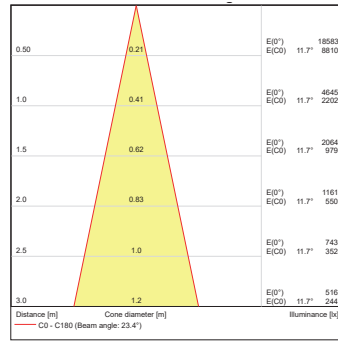
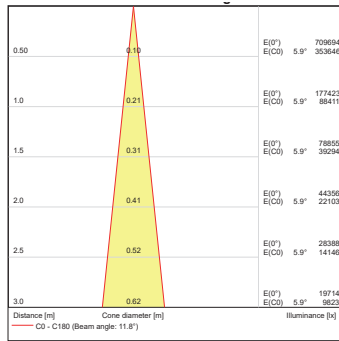
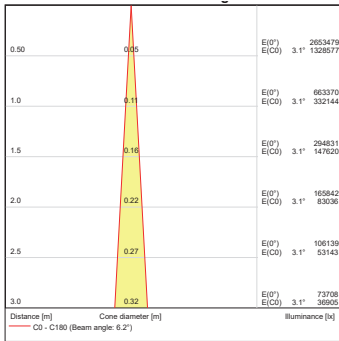
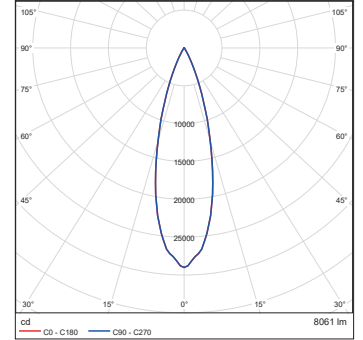

Divine 72 RGBCW 45dg

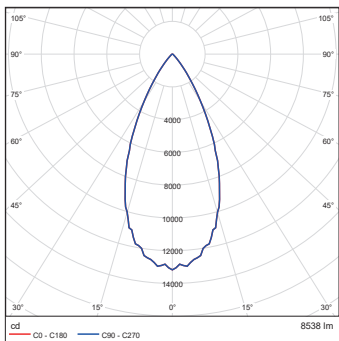

Divine 72 RGBCW 60dg

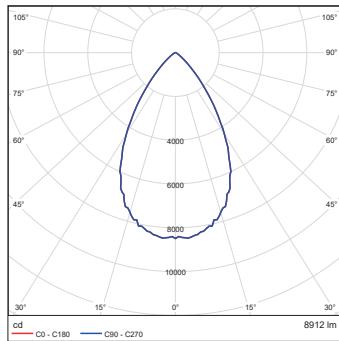

Divine 72 RGBCW 100dg

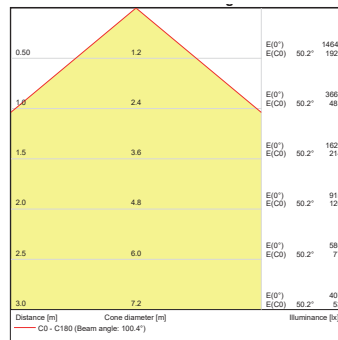
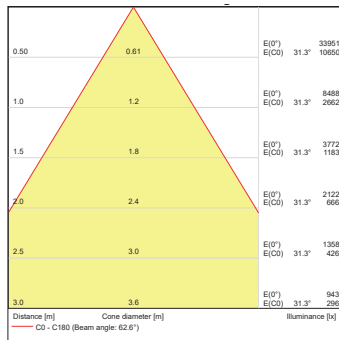
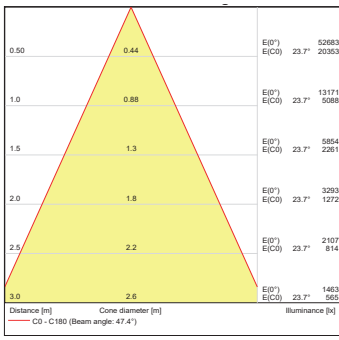
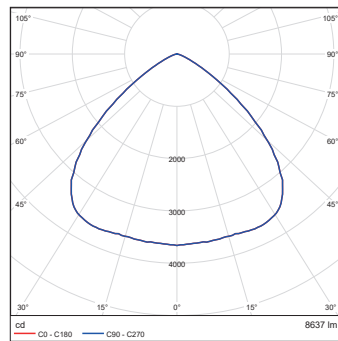

PHOTOMETRIC DATA

Divine 72 RGBCW 6dg x 30dg

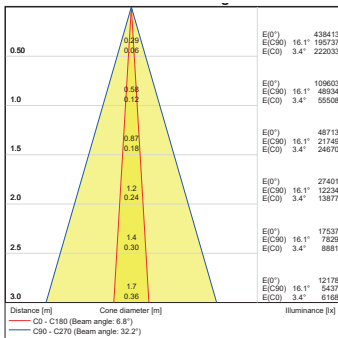
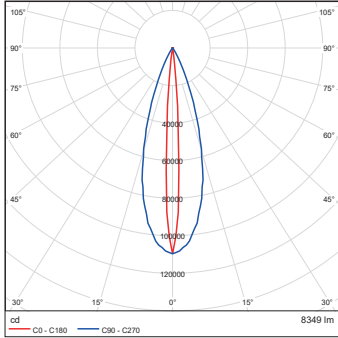

Divine 72 RGBCW 30dg x 6dg

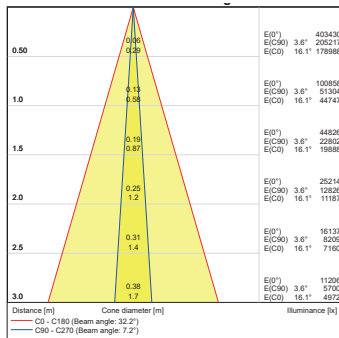
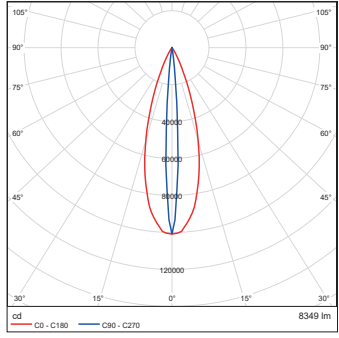

Divine 72 RGBCW 6dg x 60dg

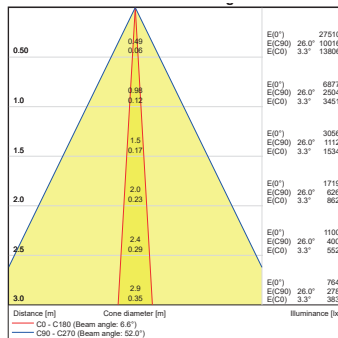
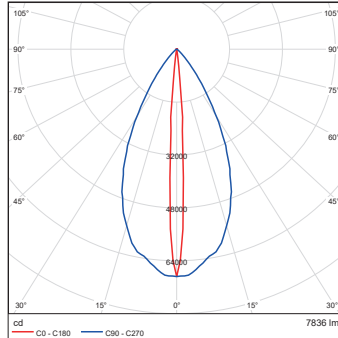

Divine 72 RGBCW 60dg x 6dg

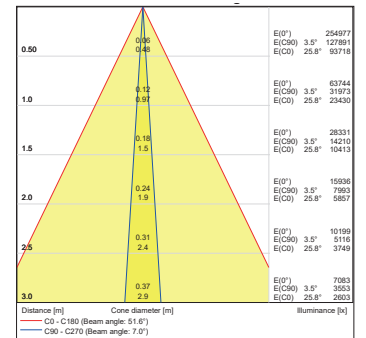
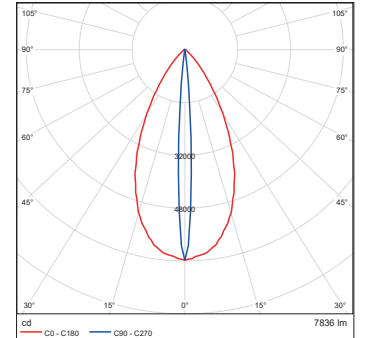

Divine 72 RGBCW 10dg x 40dg

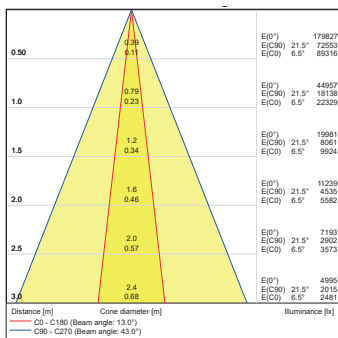
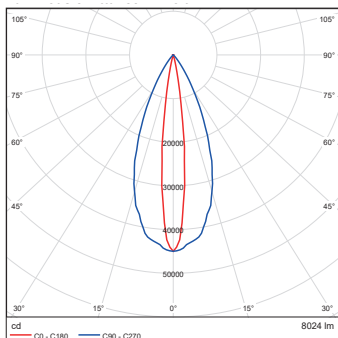

Divine 72 RGBCW 40dg x 10dg

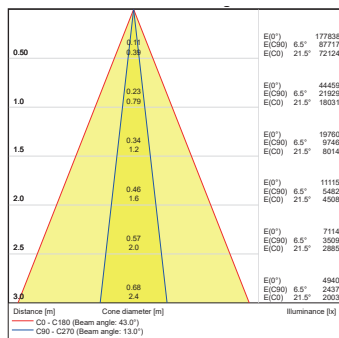
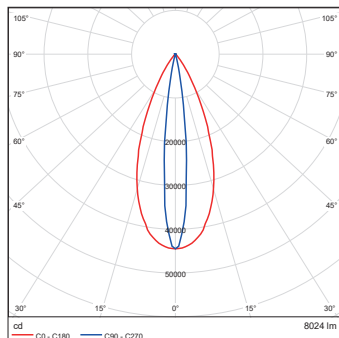

Divine 72 RGBCW 10dg x 90dg

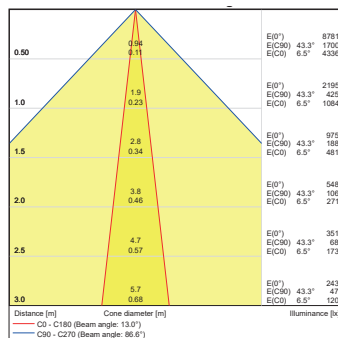
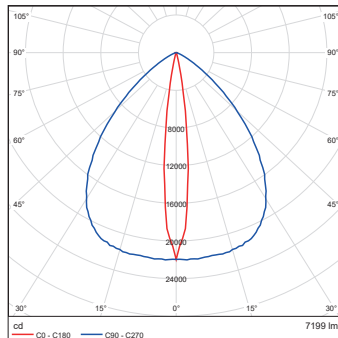

Divine 72 RGBCW 90dg x 10dg

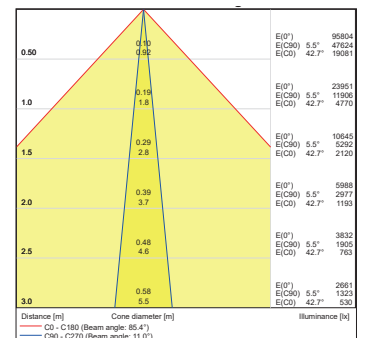
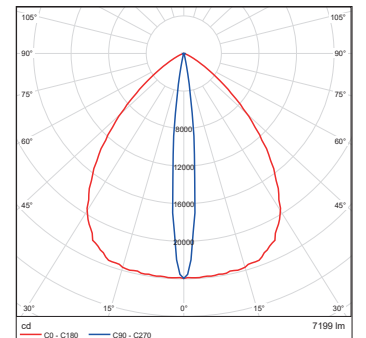

PHOTOMETRIC DATA

Divine 72 RGBCW 35dg x 70dg

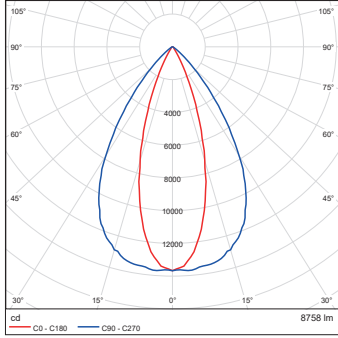

Divine 72 RGBCW 70dg x 35dg

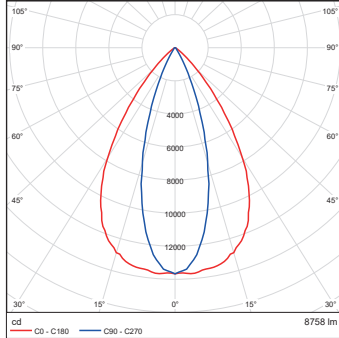

Divine 72 RGBCW 30dg x 90dg

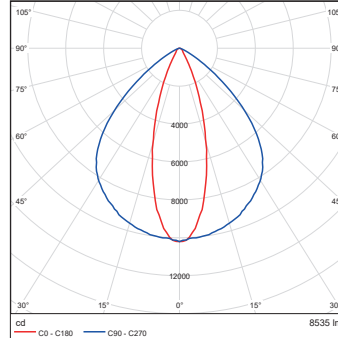

Divine 72 RGBCW 90dg x 30dg

