

DIVINE™ 160

The Divine 160 is a high-performance 440 W luminaire with phenomenal light output that can be used for a variety of architectural lighting scenarios including the application of dynamic colour changing effects to building exteriors and façades, or illuminating complete areas with subtle CCT controllable white light. The Divine is available in numerous configuration options including optics for flood or accent lighting. RGBW, RGBA or PureWhite in a variety of colour temperatures combined with different mounting options and accessories make Divine a truly flexible solution.



KEY FEATURES

Physical

With a compact and lightweight construction fulfilling IP67 and IK10 certifications, the Divine 160 multichip optical system delivers superb light with enhanced 18-bit control.

Lumen Output & Light Source

Providing an output up to 11,836 lm, the fixture utilise 40 high-power multichip LEDs.

Projected Lumen Maintenance

The long 90,000 hrs LED lifetime (L90B10) make Divine 160 an ideal choice for long-term lighting applications.

Power Consumption

Typical power consumption of the luminaire is 440 W.

COLOURS



COLOUR TEMPERATURE

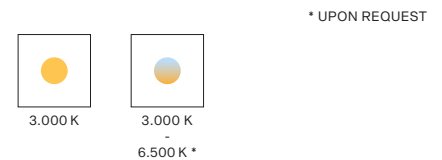

CONTROL & PROTOCOLS



OPTIC OPTIONS

SYMMETRICAL

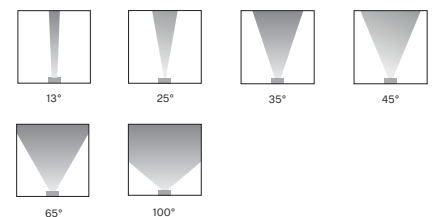

BI-SYMMETRICAL

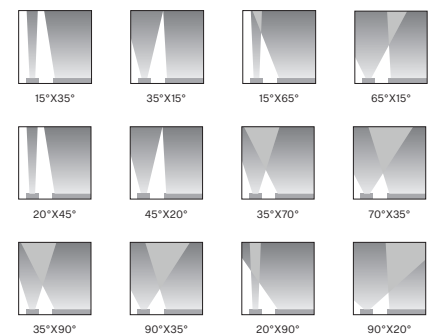

STANDARD & SPECIFICATION

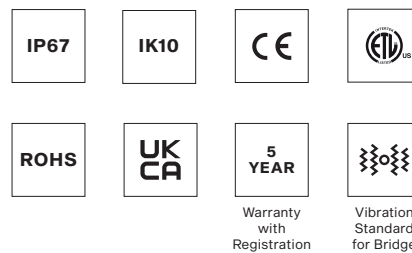

FINISH OPTIONS

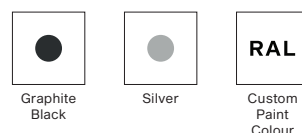

DIVINE 160 SPECIFICATION

ELECTRICAL	Input Voltage	100 - 277 V AC 50/60 Hz	
	Typical Power Consumption	440 W	
	Inrush Current	30 A @ 230 V, 20 A @ 115V	
OPTICAL	Light Source	40 x High Power Multichip LEDs	
	Colour Variants	RGBW (W - 6500 K) RGBA PW (W - 3000 K) TW (3000 - 6500 K) Upon Request	
	Beam Angle	Symmetrical: 13° 25° 35° 45° 65° 100°	
		Bi-symmetrical: 15° x 35° 35° x 15° 15° x 65° 65° x 15° 20° x 45° 45° x 20° 35° x 70° 70° x 35° 35° x 90° 90° x 35° 20° x 90° 90° x 20°	
	Lumen Output Delivered	11.836 lm (RGBW 13°, all LEDs on full)	
Projected Lumen Maintenance	L90B10 >90.000 hrs, Ta = 25°C / 77°F		
CONTROL	Display	LED Display (Inside Integrated Junction Box)	
		Chassis Mounted LED Display (Optional)	
	Wireless DMX (Option)	Lumen Radio CRMX Technology	
	Interface Protocol	USITT DMX512, RDM, 0-10 V (PW only)	
	Control System	Third Party DMX Controllers	
	Operating Modes	DMX, Stand-alone	
	DMX Modes Channels	4 (for RGBW version) 10, 22, 5, 4	
	Programs / Functions / Features	Editable Program: 1 (up to 40 steps)	
	Settings / Addressing	Via LED Display with Control Buttons or RDM	
	Power Supply	Integrated	
PHYSICAL	Width x Height x Depth	463 x 314 x 175 / 237 mm (18.2 x 12.4 x 6.9 / 9.3 in.)	
	Weight	13.4 kg / 29.54 lbs	
	Housing	High Pressure Die-Cast Aluminium Body Tempered Glass	
	Finish Options	Standard Colour - Graphite Black (RAL 9011), Silver (RAL 9006)	Cost Option - Custom RAL
	Cables / Connections	Integrated Junction Box With Terminal Block	
		Recommended: Li9Y11Y 3 x AWG16 + 1(2 x AWG24)	
	Mounting Method	Surface Mount, Flush (J-Box), C-Clamp (For Side Connection Only)	
	Adjustability	+35° / -150°	
	Protection Factor	IP67 / Suitable For Wet Locations	
	IK Rating	IK10	
	Cooling System	Convection	
	Operating Ambient Temperature	-20 °C / +40 °C (-4 °F / +104 °F)	
	Operating Temperature	+75 °C @ Ambient +40 °C (+167 °F @ Ambient +104 °F)	
	Total Heat Dissipation	1500 BTU/h (calculated)	
CERTIFICATION	Listings	ETL / cETL, CE, RoHS, UKCA	
ACCESSORIES	Included Items		
		Surface Mount Adaptor	
	Not Included Items		
		Optical Demo Set for Divine 160	
		Top Hat Divine 160	
		Half Top Hat Divine 160	
		Barndoor Module Divine 160	
		Wire Guard/Anti-Glare Divine 160	
		Set of Rubber Feet	
		C-Clamp Adaptor Divine (for side conn. only)	
		Single Top Loader Case Divine	

DIMENSIONS

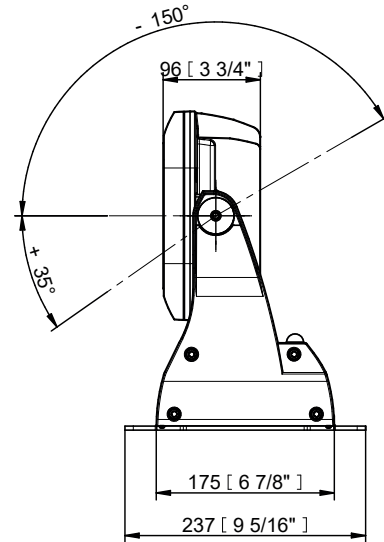
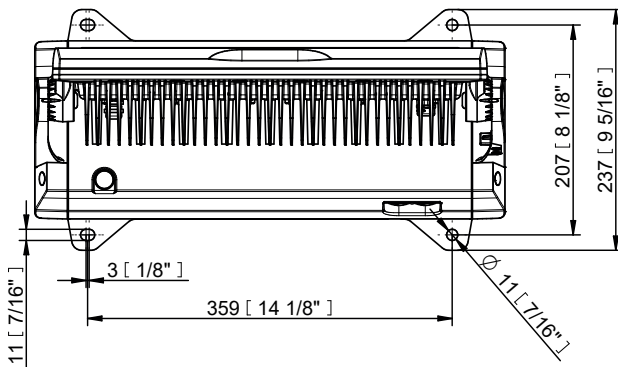
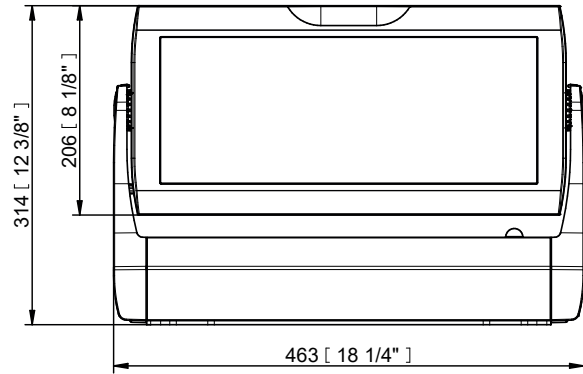
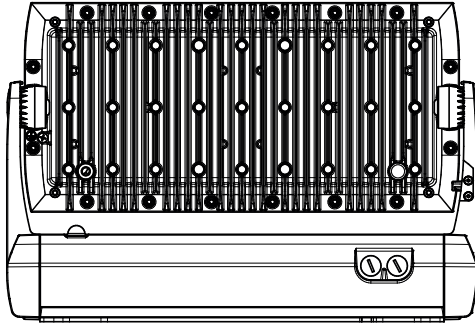

PROJECTED AREA

		m ²	ft ²
Divine 160	Front (rear)	0,13	1,40
	Side	0,03	0,32
	Top	0,08	0,86
Divine 160 with Top Hat	Front (rear)	0,13	1,40
	Side	0,0475	0,511
	Top	0,11	1,18
Divine 160 with Half Top Hat	Front (rear)	0,13	1,40
	Side	0,0421	0,453
	Top	0,11	1,18

ACCESSORIES FOR DIVINE 160

Top Hat Divine 160

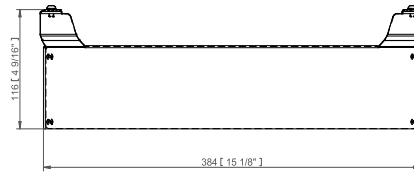
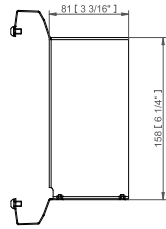
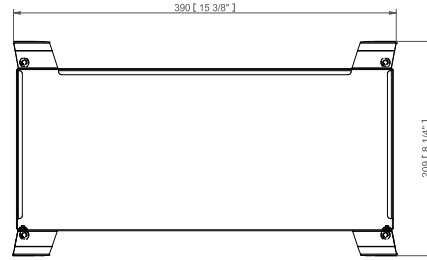

Half Top Hat Divine 160

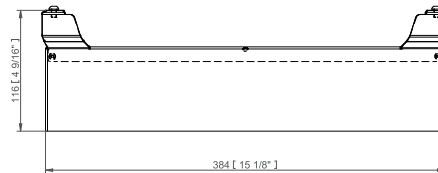
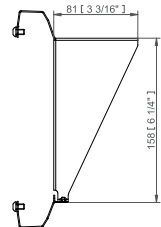
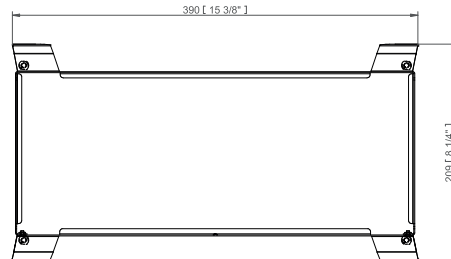

Barndoor Module Divine 160

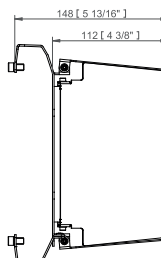
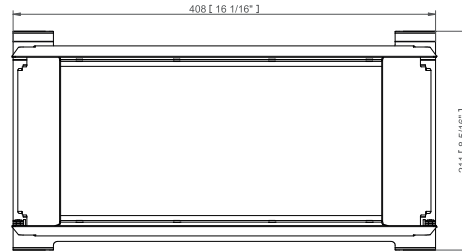

C-Clamp Adaptor Divine (for side conn. only)

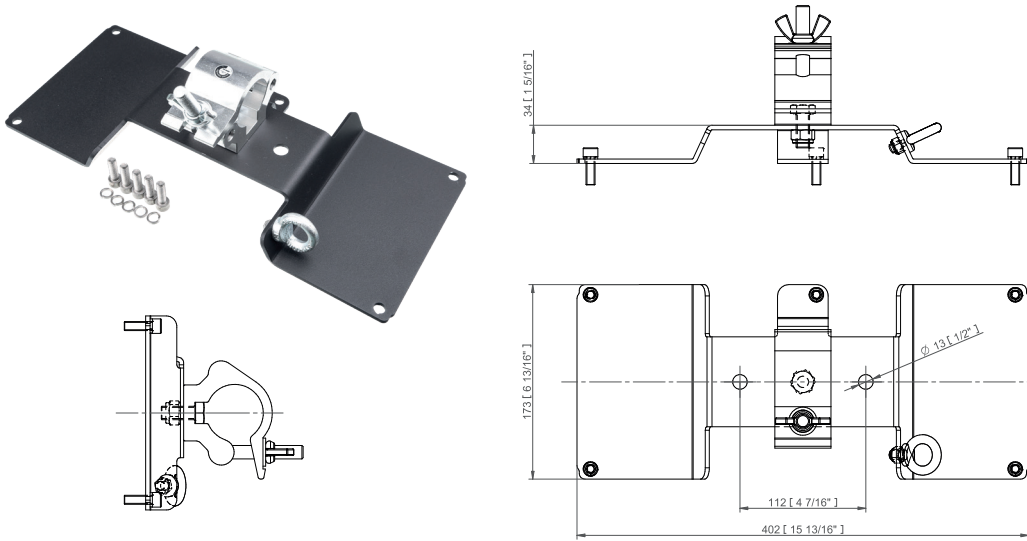

Set of Rubber Feet - Graphite / Silver



Wire Guard /Anti-Glare Divine 160

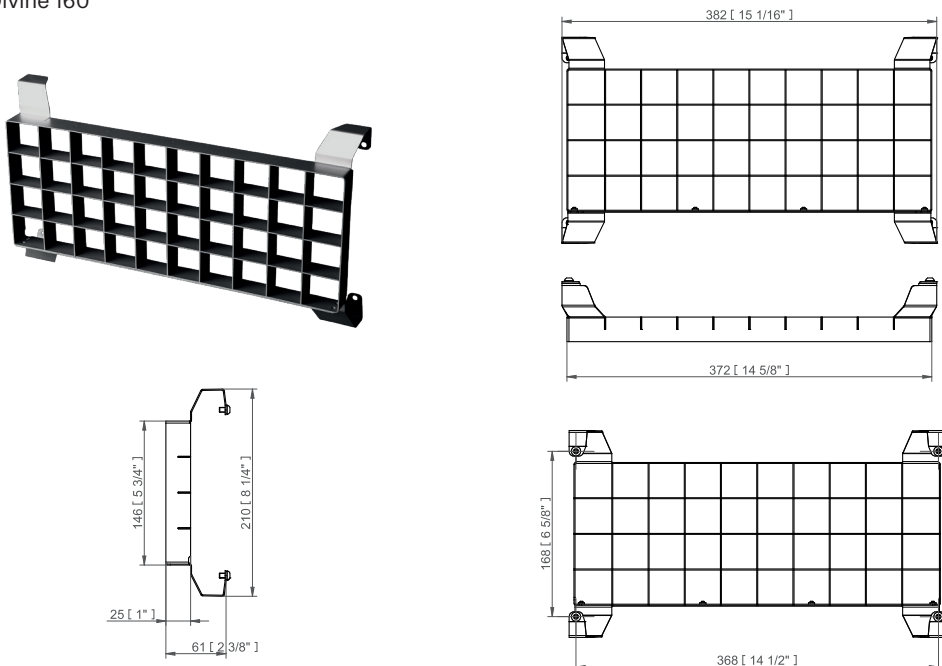

PHOTOMETRIC OVERVIEW

	Lumen Output (lm)		
	RGBW (W - 6500 K)	RGBA	PW (3000 K)
13°	11 836	7 697	9 673
25°	10 903	7 090	8 910
35°	10 882	7 076	8 893
45°	10 876	7 072	8 888
65°	10 842	7 050	8 860
100°	10 514	6 837	8 592
15° x 35°, 35° x 15°	10 628	6 911	8 685
15° x 65°, 65° x 15°	11 017	7 164	9 003
20° x 45°, 45° x 20°	10 981	7 141	8 974
35° x 70°, 70° x 35°	10 912	7 096	8 918
35° x 90°, 90° x 35°	10 495	6 825	8 577
20° x 90°, 90° x 20°	11 022	7 167	9 007

BI-SYMMETRICAL BEAM ANGLES

Bi-symmetrical: 15°x35°, 15°x65°, 20°x45°, 35°x70°, 35°x90°, 20°x90°

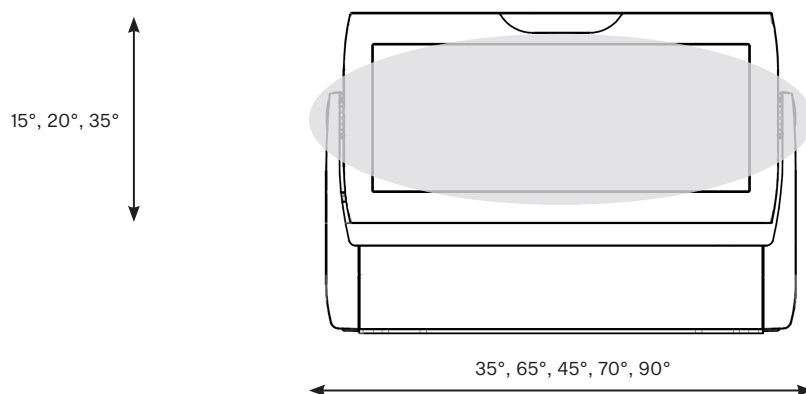

Bi-symmetrical: 35°x15°, 65°x15°, 45°x20°, 70°x35°, 90°x35°, 90°x20°

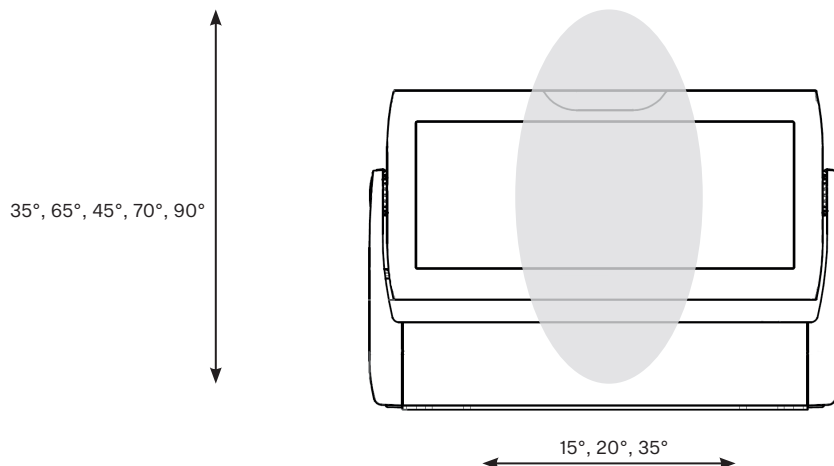

PHOTOMETRIC DATA

Divine 160 RGBCW 13dg

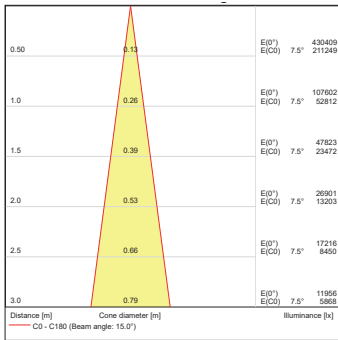
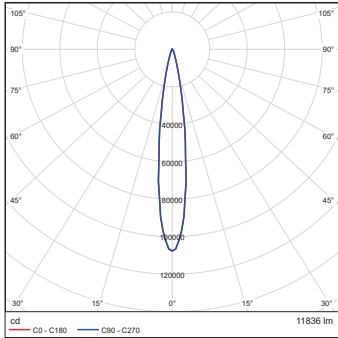

Divine 160 RGBCW 25dg

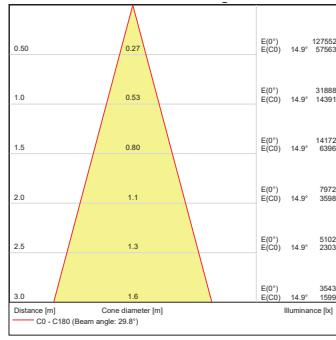
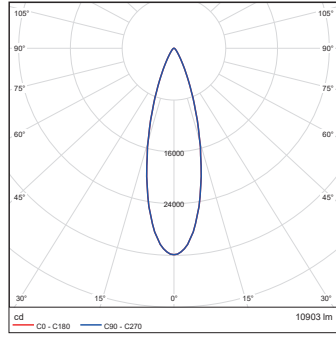

Divine 160 RGBCW 35dg

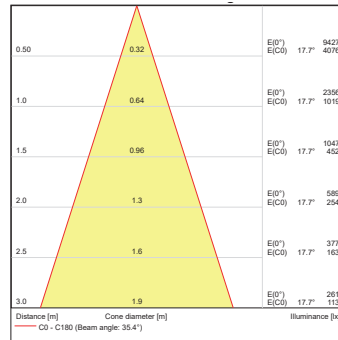
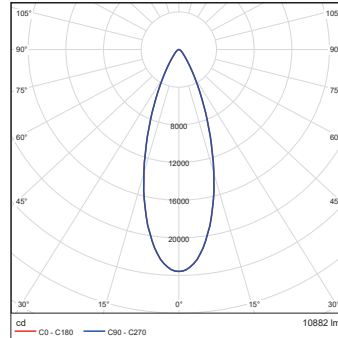

Divine 160 RGBCW 45dg

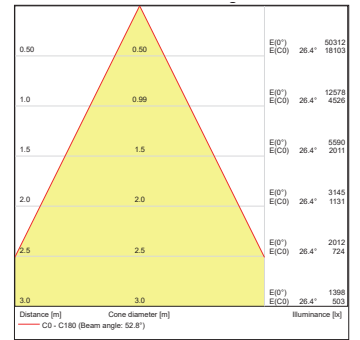
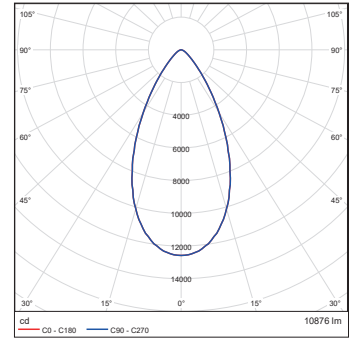

Divine 160 RGBCW 65dg

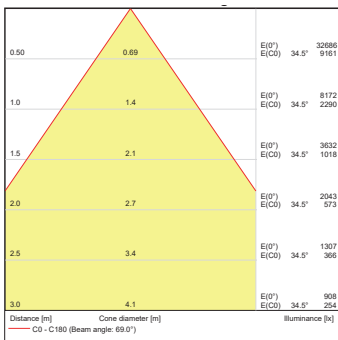
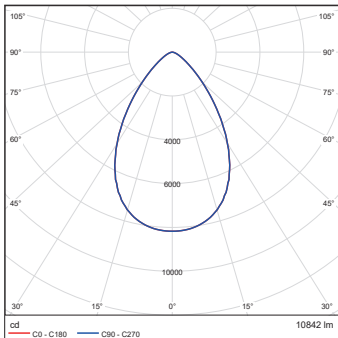

Divine 160 RGBCW 100dg

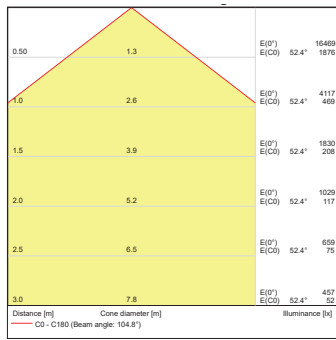
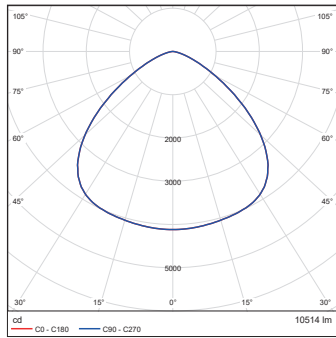

PHOTOMETRIC DATA

Divine 160 RGBCW 15dg x 35dg

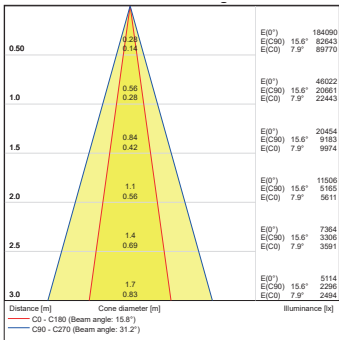
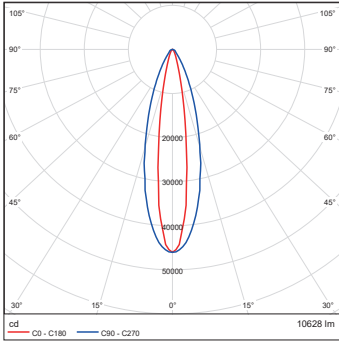

Divine 160 RGBCW 35dg x 15dg

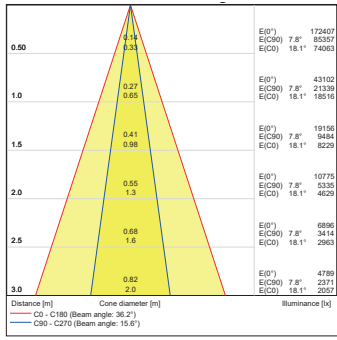
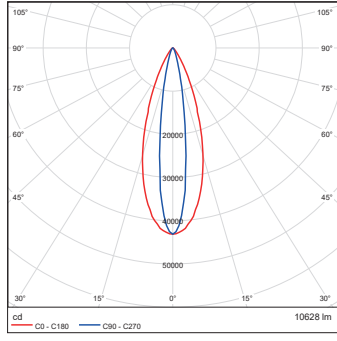

Divine 160 RGBCW 15dg x 65dg

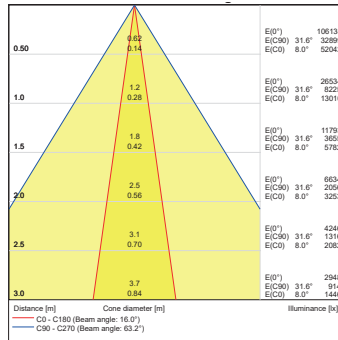
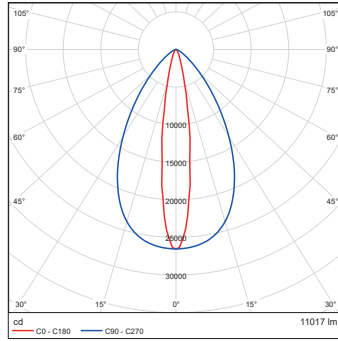

Divine 160 RGBCW 65dg x 15dg

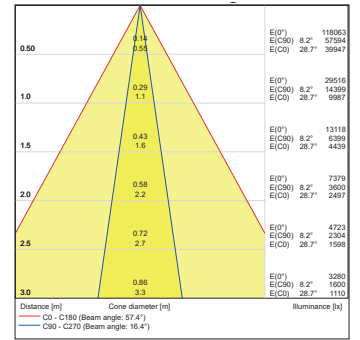
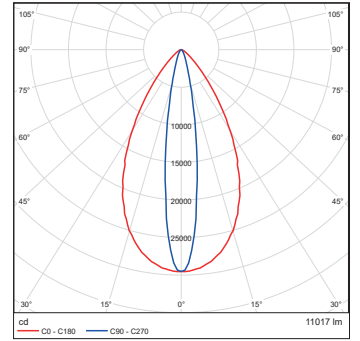

Divine 160 RGBCW 20dg x 45dg

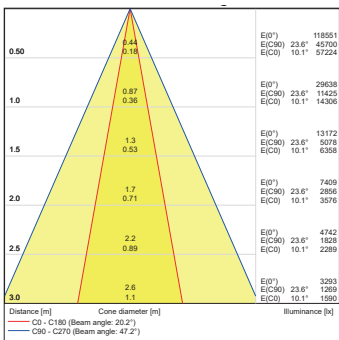
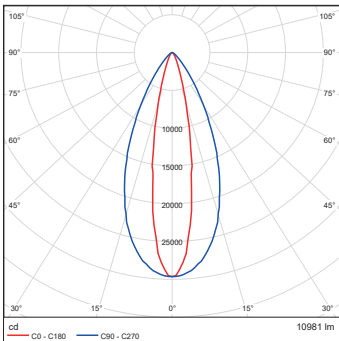

Divine 160 RGBCW 45dg x 20dg

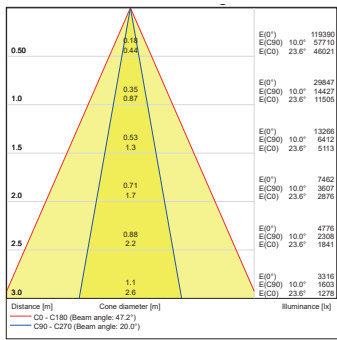
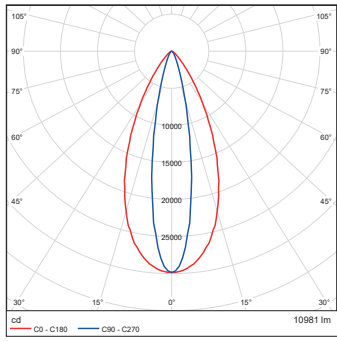

Divine 160 RGBCW 35dg x 70dg

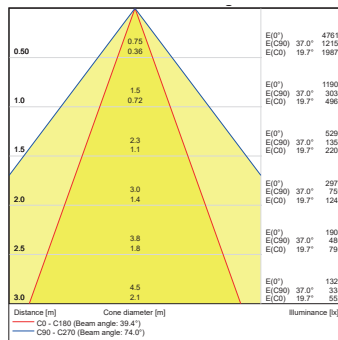
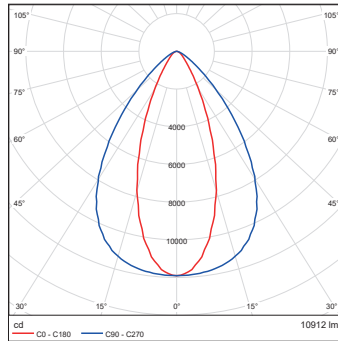

Divine 160 RGBCW 70dg x 35dg

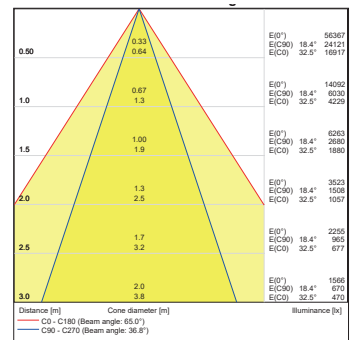
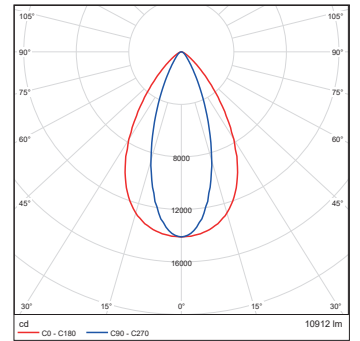

PHOTOMETRIC DATA

Divine 160 RGBCW 35dg x 90dg

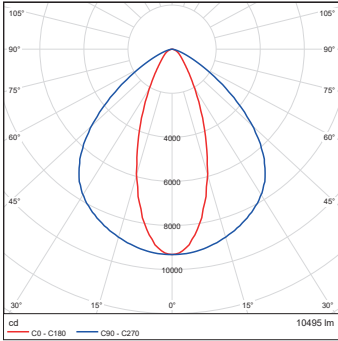

Divine 160 RGBCW 90dg x 35dg

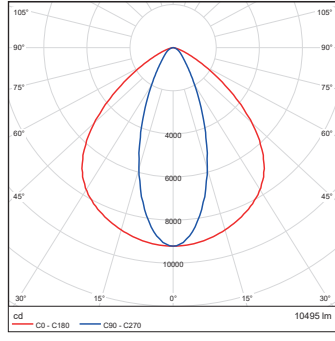

Divine 160 RGBCW 20dg x 90dg

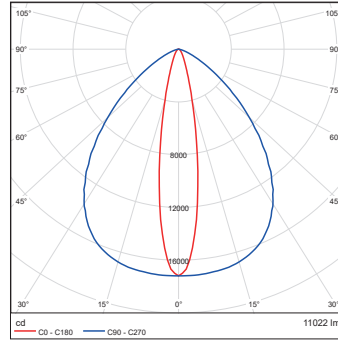

Divine 160 RGBCW 90dg x 20dg

