

# AMBIANE™ AP

Compact and powerful downlight from Ambiane range is suitable for ambient lighting applications, wall washing and accent lighting where light quality is of the utmost importance. Its high CRI output, simple control mode with CCT, green correction, and perfectly matching dimming curve with tungsten lamps give lighting designers a unique solution without any compromises. Available in RGBW and tunable white CCT versions, along with two beam angles options, the cool-running Ambiane AP is UV or IR radiation free making it ideal for a wide array of applications including theatres, auditoriums, ballrooms, hotels, offices, restaurants, retail environments and more. With both DMX and DALI control options, combined with a highly efficient LED source and high quality reflectors for optimum light output, the Ambiane AP can produce truly dramatic results!



## KEY FEATURES

### LED Output

Available in wide range of colour configurations (RGBW, PW, TW and TD), the high-efficiency LED modules of the Ambiane AP provides the highest possible luminous flux 2713 lm. With two different beam spreads to choose from (67° and 80°), the equally homogenised light output is secured by precisely designed output optics, and the fixture provides a 90,000 hour LED lifetime guaranteeing a dependable performance.

### Control

Thanks to our unique L3 (low light linearity) 18-bit dimming system, exceptionally smooth fade to black and colour mixing are now possible. The fixture's remote setting and device management is realised through DALI and DMX512 control protocols with RDM support and intelligent power balancing (always 50 W output in any mixed colour).

### Installation

Fixture is mounted via spring clip holders into false ceiling low 48 V DC input voltage secures a safe light operation with the possibility of backup power connection to protect against any unexpected blackout.

## COLOURS



## COLOUR TEMPERATURE

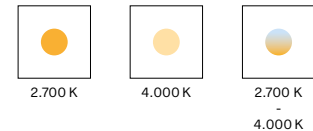

## CONTROL & PROTOCOLS



## OPTIC OPTIONS

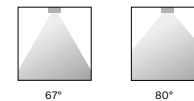

## STANDARD & SPECIFICATION

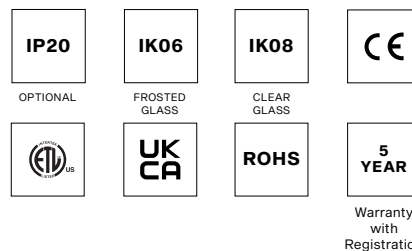

## FINISH OPTIONS

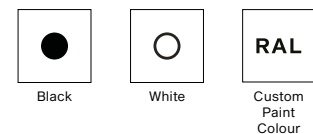

**AMBIANE AP SPECIFICATION**

<b>ELECTRICAL</b>	Input Voltage	48 V DC			
	Typical Power Consumption	50 W			
<b>OPTICAL</b>	Light Source	High Power Single Chip LEDs			
	Colour Variants	RGBW (W - 2700 K or 4000 K)	PureWhite	Tunable White	Tungsten Dim
	Colour Temperature of White	PW 2700 K or 4000 K   TW 2700-4000 K   TD 3200 K			
	CRI	90+			
	Beam Angle	67°   80°			
	Lumen Output Delivered	2.713 lm (RGBNW 4000 K @ 67°)		2.495 lm (RGBNW 4000 K @ 80°)	
	Projected Lumen Maintenance	L90B10 >90.000 hrs, Ta = 25°C / 77°F			
<b>CONTROL</b>	Interface Protocol	USITT DMX512, RDM, DALI 2, 0-10 V			
	DALI 2 Device Type	DT 8			
	Control System	ArcControl Range or any Third Party Controller			
	DMX Modes   DMX Channels	5 (for RGBW version)   4, 3, 12, 3, 6			
	Settings / Addressing	DIP Switch			
	Power Supply	Ambiane Power AP, Ambiane Power Rack (CE/US) or Third Party Constant Voltage 48 V / 75 W Power Supply			
<b>PHYSICAL</b>	Width x Height x Depth   Weight	ø232 x 116 x 266 mm (ø9.13 x 4.57 x 10.47 in.)   1.9 kg   4.19 lbs			
	Housing	High Pressure Die-Cast Aluminium Body			
	Finish Options	Standard Color - White RAL 9016, Black RAL 9005		Cost Option - Custom RAL	
	Cables / Connections	Terminal Block (Power In, DMX In/Out, DALI In/Out, Secondary power Input)			
	Mounting Method	Recessed, Via Two Spring Clips. Cut-Out Diameter: 212 mm / 8.34 in.			
	Protection Factor	IP20 (Option: Below part IP54 with attached front clear or frosted glass - valid for part of the luminaire with glass under the ceiling)			
	IK Rating	IK08 (IP54 option with Clear Glass)		IK06 (IP54 option with Frosted Glass)	
	Cooling System	Convection			
	Operating Ambient Temperature	- 20 °C / +45 °C (-4 °F / +113 °F)			
	Operating Temperature	+75 °C @ Ambient +35 °C (167 °F @ Ambient 95 °F)			
<b>CERTIFICATION</b>	Listings	ETL / cETL, CE, RoHS, UKCA			
<b>ACCESSORIES</b>	<b>Included Items</b>				
	Optical	Anti-Glare Ring			
	<b>Not Included Items</b>				
	Mounting	Adapter Ring for Ø235-255 mm + Spring Clip Set			
	Power supply	Ambiane Power AP (MeanWell ELG-75-48-3Y) Ambiane Power Rack (CE / US)			

**DIMENSIONS**

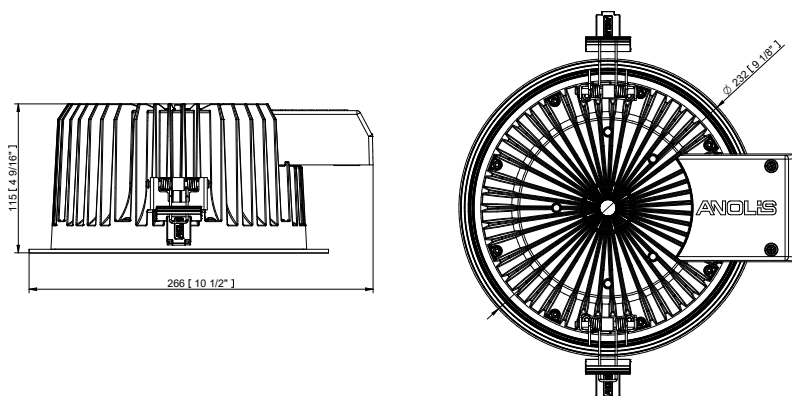

**AMBIANE POWER RACK (CE / US) SPECIFICATION**

<b>ELECTRICAL</b>	Input Voltage	100 – 240V AC 50/60 Hz (Ambiane Power Rack) 100 – 277V AC 50/60 Hz (Ambiane Power Rack US)
	Maximal Power Consumption	1350W
	Output Voltage	48 V DC
	Outputs	8
	Max. Load per output	200W
	Max. Total Load	1200W
	<b>PHYSICAL</b>	Length x Height x Depth
Weight		5.4 kg   11.9lbs
Housing		Rack Standard - 2U or Wall Mounted Brackets
Finish Options		Standard Colour - Graphite Black (RAL 9011)   Silver (RAL9006) Cost Option - Custom RAL
Cables / Connections		8 x Terminal Block (DC power Out) 1x Main Power Cord (w/plug; CE/US)
Mounting Method		Designed to Rack Box Installation
Protection Factor		IP20 / Dry locations only
Cooling System		Fan Cooled
Operating Ambient Temperature		-20 °C / +40 °C (-4 °F / +104 °F)
<b>CERTIFICATION</b>		Listings

**AMBIANE POWER RACK DIMENSIONS**

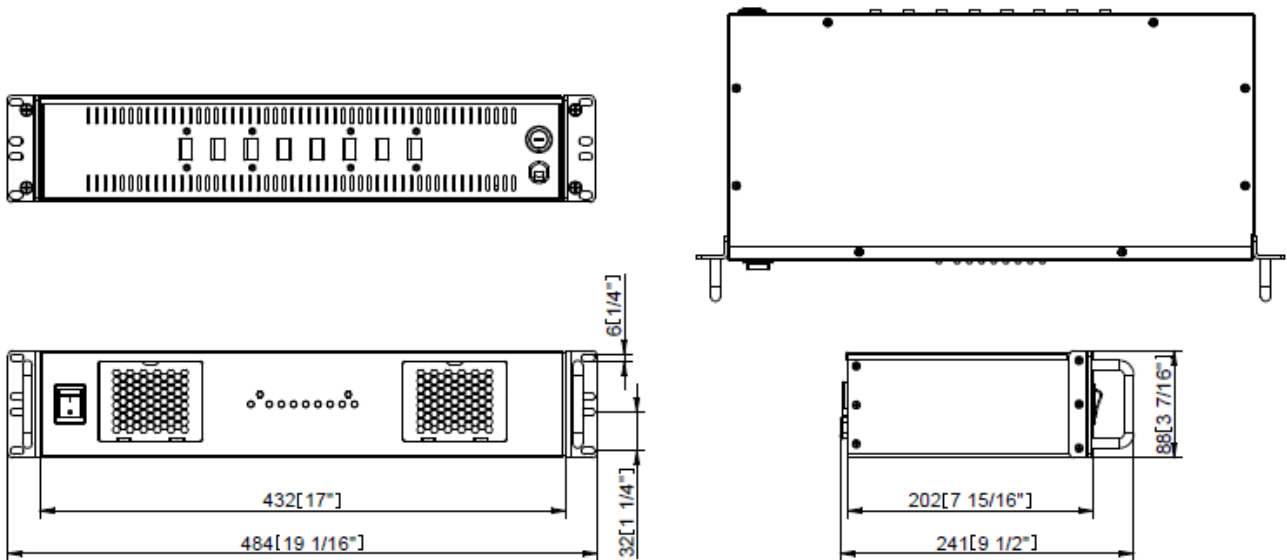

**DIAMETER OF CONDUCTORS**

Recommended diameters of conductors with respect to distance between Fixture and Power supply.

<b>Distance / Cable length</b>	50 m	100 m
<b>Diameters of conductors</b>	0.5 mm <sup>2</sup>	1 mm <sup>2</sup>

**PROTECTION FACTOR**

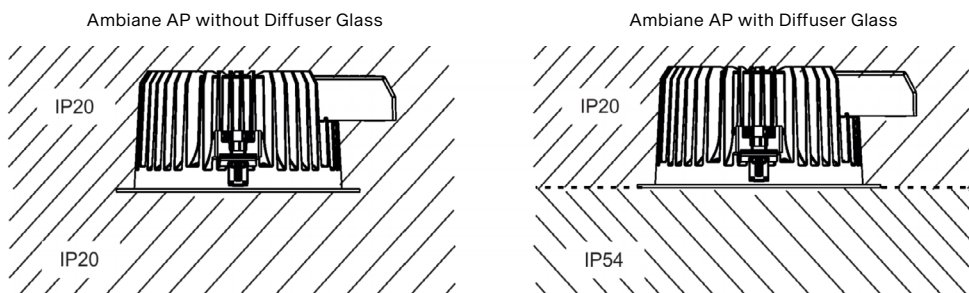

**ACCESSORIES FOR AMBIANE AP**

Adapter Ring for Ø235-255 mm + Spring Clip Set

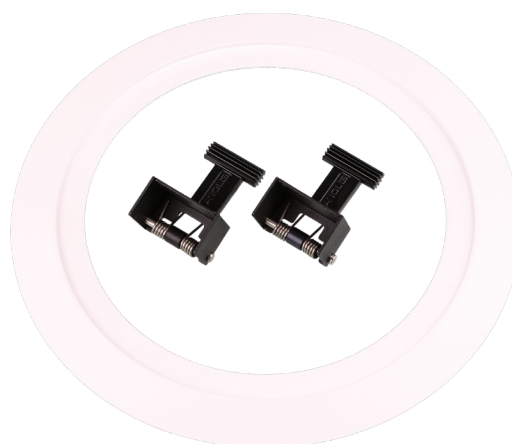

**PHOTOMETRIC OVERVIEW**

Lumen Output (lm)

		RGBWW (2700 K)	RGBNW (4000 K)	PW (2700 K)	PW (4000 K)	TW (2700 K - 4000 K)	TD (3200 K)
67°	simple	1 819	2 713	3 398	4 093	2 792 - 2 713	2 907
	with Glass	1 736	2 589	3 243	3 906	2 664 - 2 589	2 774
	with Frosted Glass and Anti-Glare	1 672	2 495	3 125	3 764	2 568 - 2 495	2 673
	with Frosted Glass, without Anti-Glare	1 800	2 685	3 363	4 051	2 763 - 2 685	2 877
80°	simple	1 672	2 495	3 125	3 764	2 568 - 2 495	2 673
	with Glass	1 582	2 359	2 955	3 559	2 428 - 2 359	2 528
	with Frosted Glass and Anti-Glare	1 515	2 260	2 831	3 410	2 326 - 2 260	2 421
	with Frosted Glass, without Anti-Glare	1 617	2 412	3 021	3 639	2 482 - 2 412	2 585

**UNIFIED GLARE RATING (UGR)**

UGR	
67°	< 21 UGR
80°	< 22 UGR

COLOR RENDITION REPORT (TM-30-18 METHOD)

Ambiane AP RGBNW version

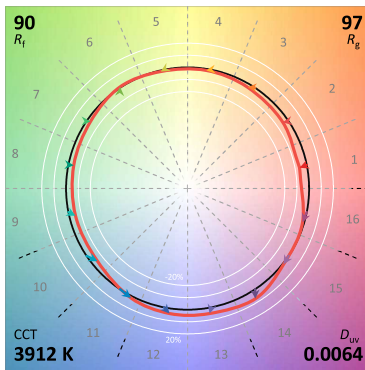
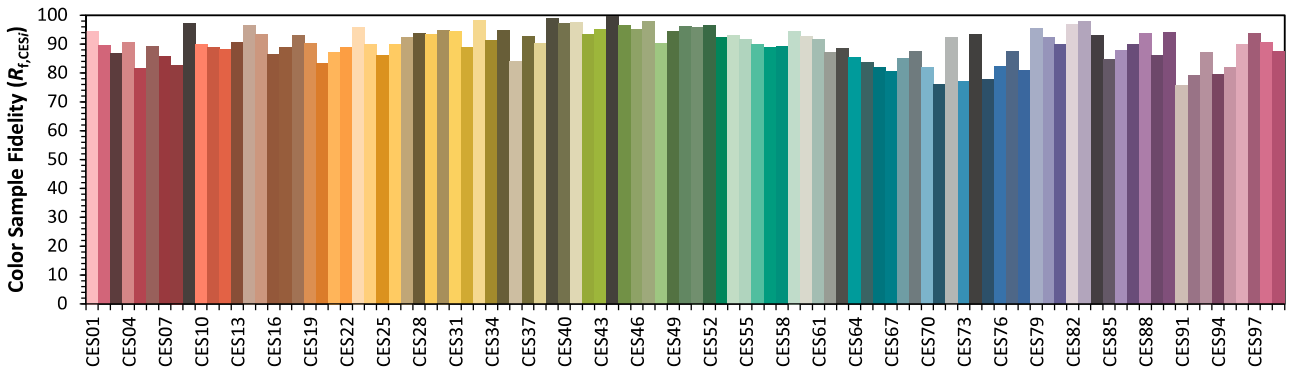

CIE 13.3-1995 (CRI)	
$R_a$	88
$R_g$	49

Ambiane AP RGBWW version

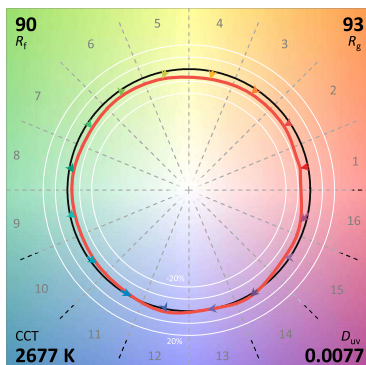
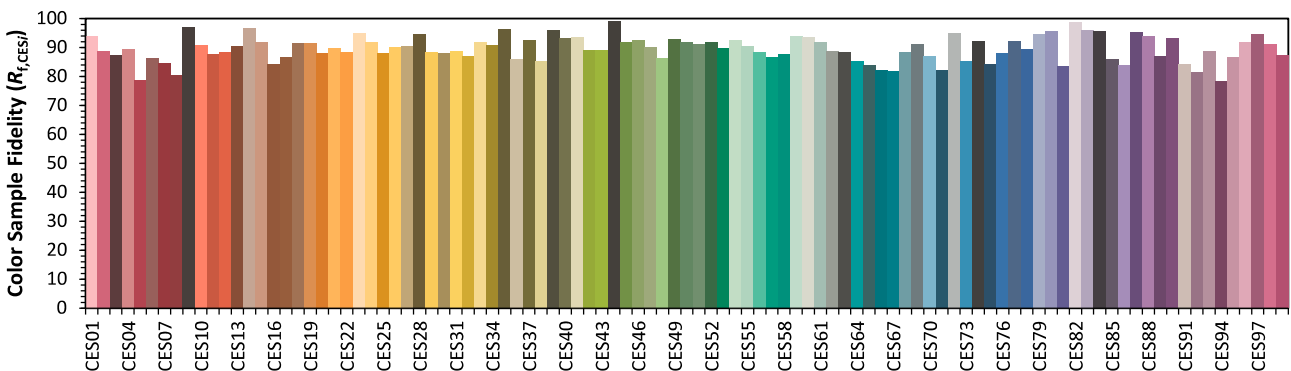

CIE 13.3-1995 (CRI)	
$R_a$	88
$R_g$	46

PHOTOMETRIC DATA

Ambiane AP RGBNW 67dg

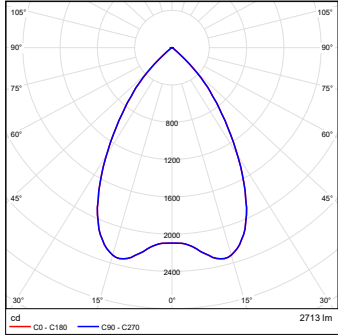

Ambiane AP RGBNW 67dg; with Glass

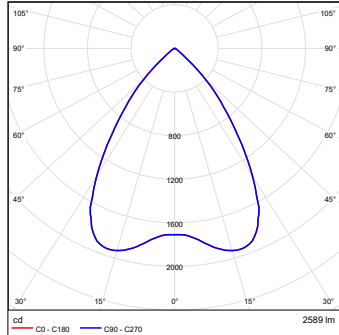

Ambiane AP RGBNW 67dg; with Frosted glass and Anti-Glare ring

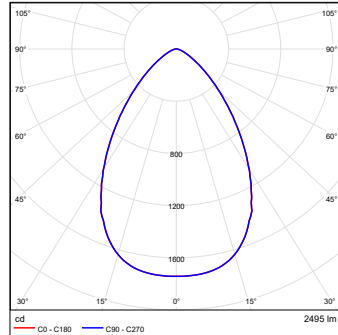

Ambiane AP RGBNW 67dg; with Frosted glass; without Anti-Glare ring

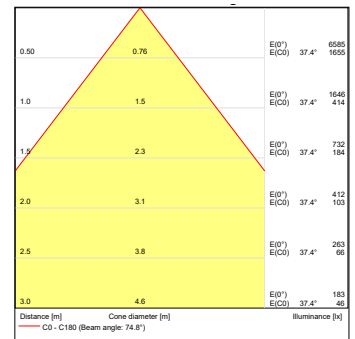
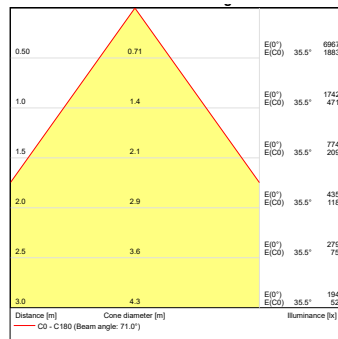
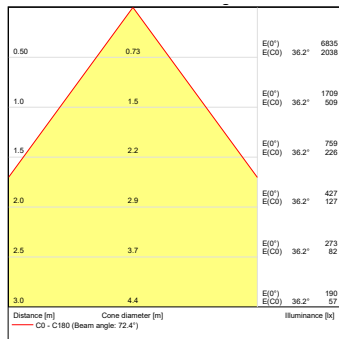
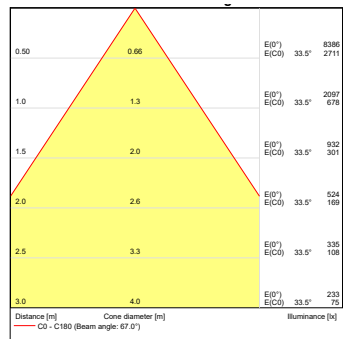
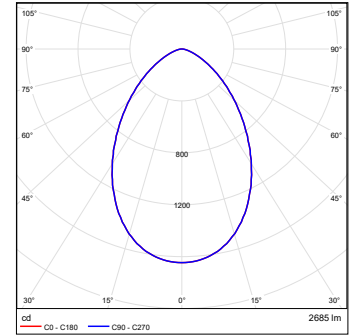

Ambiane AP RGBNW 80dg

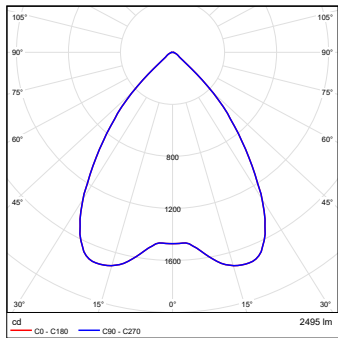

Ambiane AP RGBNW 80dg; with Glass

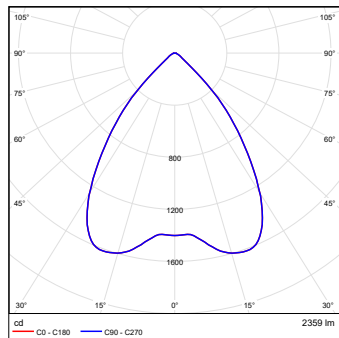

Ambiane AP RGBNW 80dg; with Frosted glass and Antiglare ring

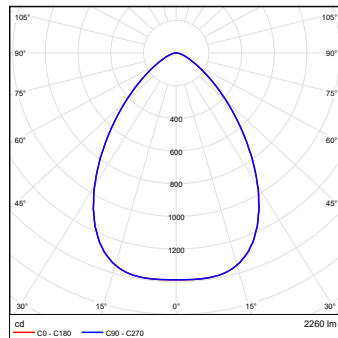

Ambiane AP RGBNW 80dg; with Frosted glass; without Antiglare ring

