

ARCSOURCE™ 4MC II

Offering spectacular performance and seamless colour mixing within a small package, the ArcSource 4MC II is perfect for a broad range of interior applications. Advanced cooling and driver technology have been integrated into the fixture to deliver maximum light output without sacrificing LED longevity or increasing energy consumption making ArcSource 4MC II a versatile architectural fixture.



KEY FEATURES

Homogenised colour mixing or fixed white from a discrete, recessed, bright luminaire.

Lumen Output & Light Source

Lumen output of 242 lm is provided by one high-power multichip LED.

Projected Lumen Maintenance

The projected lumen maintenance is 90,000 hours (L90B10).

Power Consumption

5W energy consumption provides excellent efficiency at low operating costs.

Physical

The durable cast aluminium body with a lens covered by tempered glass provides a stylish, compact lighting solution. The fixture's physical dimensions are 72 x 101 mm (2.83 x 3.98 in) and it weighs 0.3 kg (0.66 lbs).

COLOURS

* UPON REQUEST



RGBW



Pure White



Tuneable White *

COLOUR TEMPERATURE



3.000 K



6.500 K *



3.000 K

6.500 K *

CONTROL & PROTOCOLS



STANDARD & SPECIFICATION



IP20



ROHS



CE



ETL US



UK CA



5 YEAR

Warranty with Registration

OPTIC OPTIONS

SYMMETRICAL



10°



13°



20°



30°



40°



60°



90°

BI-SYMMETRICAL



10°x30°



10°x60°



15°x90°



35°x70°



30°x10°



60°x10°



90°x15°



70°x35°

FINISH OPTIONS



Graphite Black



White



RAL

Custom Paint Colour

ARCSOURCE OUTDOOR 4MC PIXEL SPECIFICATION

ELECTRICAL	Typical Power Consumption	5 W
	Max. Input Current	350 mA (per channel)
OPTICAL	Light Source	1 x High Power Multichip LED
	Colour Variants	RGBW (W - 6500 K) PW (W - 3000 K)
		Upon Request TW (3000 - 6500 K) PW (6500 K)
	Beam Angle	Symmetrical 10° 15° 20° 30° 40° 60° 90°
		Bi-symmetrical 10° x 30° 10° x 60° 35° x 70° 15° x 90°
	Lumen Output Delivered	242 lm (RGBCW @ 10°, all LEDs on full, 350 mA)
Projected Lumen Maintenance	L90B10 >90.000 hrs, Ta = 25°C / 77°F	
CONTROL	Power Supply	ArcPower range
	Width x Height x Depth	Ø72 x 101 mm (Ø 2.83 x 3.98 in.)
	Weight	0.3 kg / 0.66 lbs
	Housing	Precision Turned Aluminium
	Finish Options	Standard Colour - Graphite Black (RAL 9011), White (RAL 9016)
Cost Option - Custom RAL		
PHYSICAL	Cables / Connections	24 AWG x 4P cat. 5 - 1.5 m (4.29 ft) - RJ45
	Mounting Method	MR16 Trim with Spring Clip (Included)
	Protection Factor	IP20
	Cooling System	Convection
	Operating Ambient Temperature	-20 °C / +40 °C (-4 °F / +104 °F)
	Operating Temperature	+44 °C @ Ambient +25 °C (+111 °F @ Ambient +77 °F)
CERTIFICATION	Listings	ETL / cETL, CE, RoHS, UKCA
ACCESSORIES		Cable splitter 1 to 2, RJ45 (included)

PHOTOMETRIC OVERVIEW

	Lumen Output (lm)	
	RGBCW (W 6500 K)	WW (3000 K)
10°	242	242
15°	244	244
20°	238	238
30°	236	236
40°	234	234
60°	220	220
90°	193	193
10° x 30°	263	263
10° x 60°	223	223
15° x 90°	202	202
35° x 70°	254	254

PHOTOMETRIC DATA

ArcSource 4MC II RGBCW 10dg

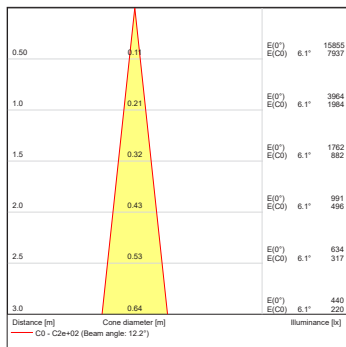
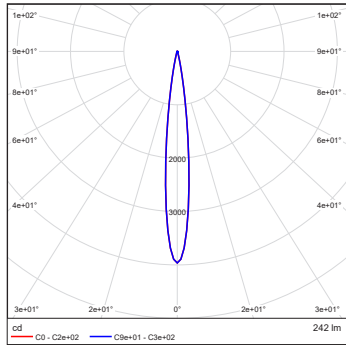

ArcSource 4MC II RGBCW 15dg

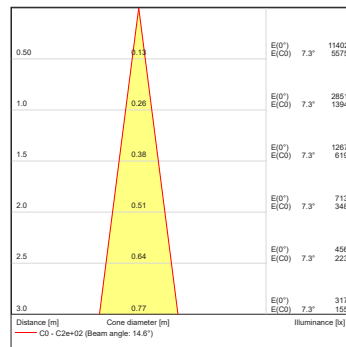
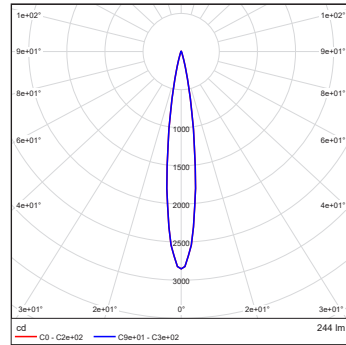

ArcSource 4MC II RGBCW 20dg

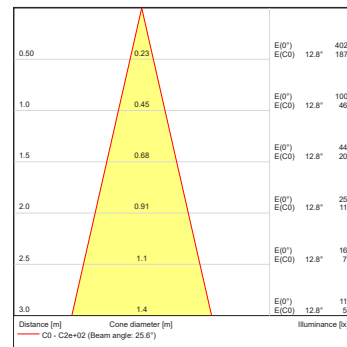
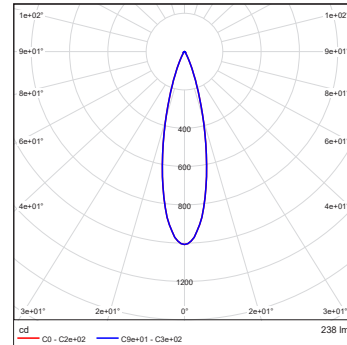

ArcSource 4MC II RGBCW 30dg

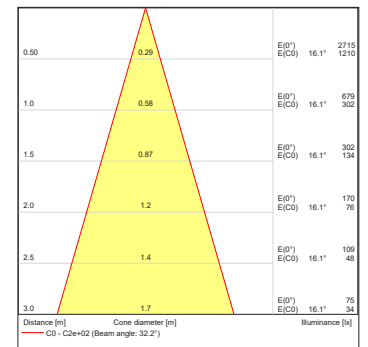
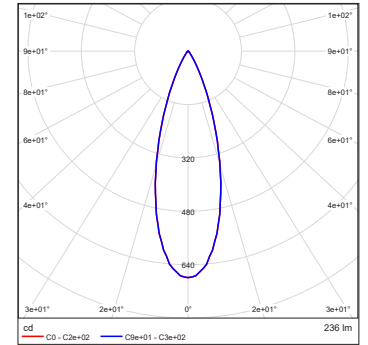

ArcSource 4MC II RGBCW 40dg

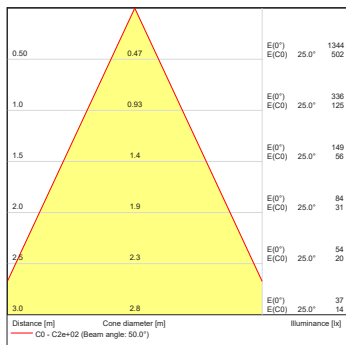
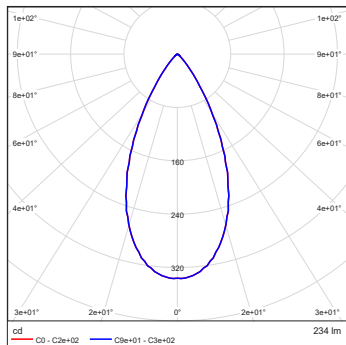

ArcSource 4MC II RGBCW 60dg

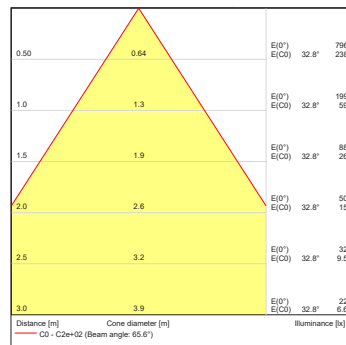
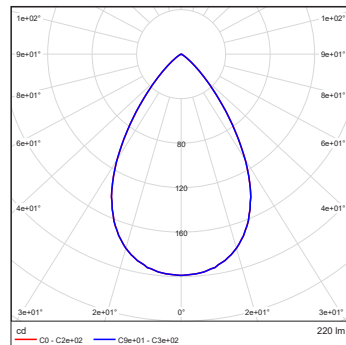

ArcSource 4MC II RGBCW 90dg

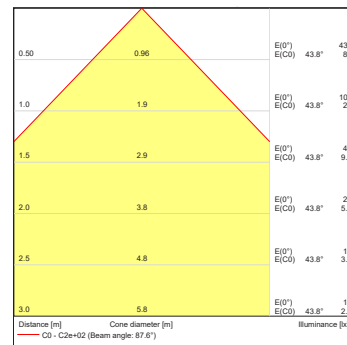
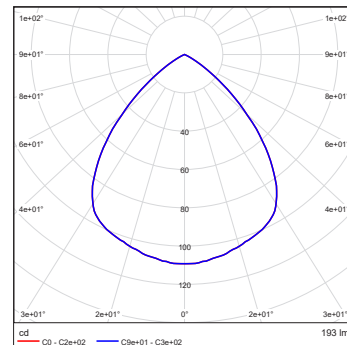

PHOTOMETRIC DATA

ArcSource 4MC II RGBCW
10dg x 30dg

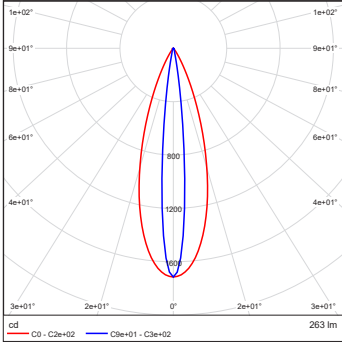

ArcSource 4MC II RGBCW
10dg x 60dg

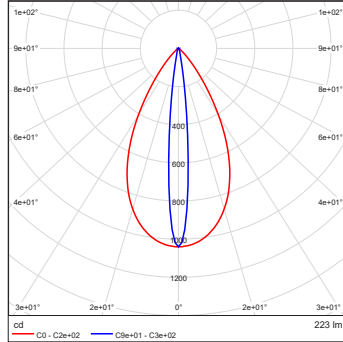

ArcSource 4MC II RGBCW
15dg x 90dg

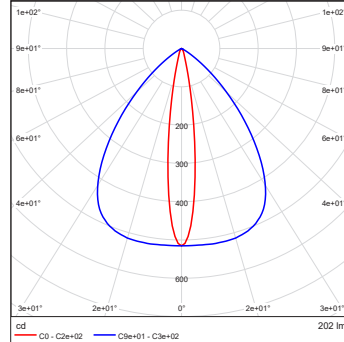

ArcSource 4MC II RGBCW
35dg x 70dg

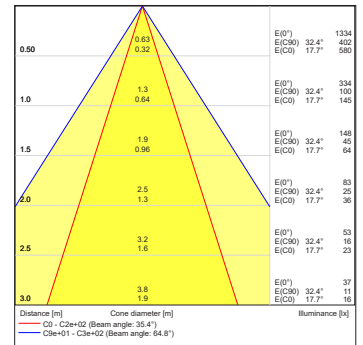
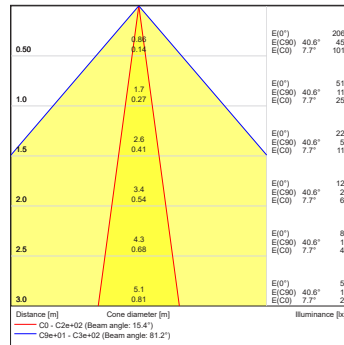
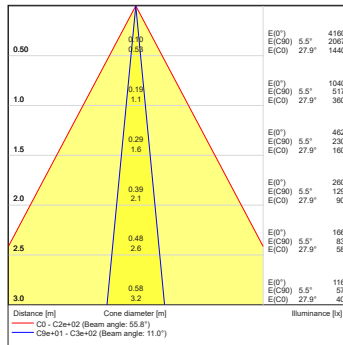
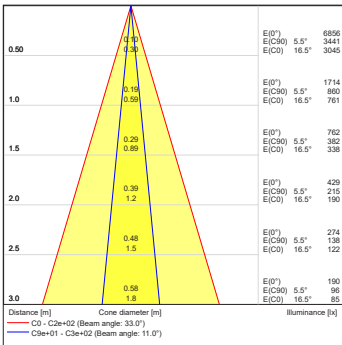
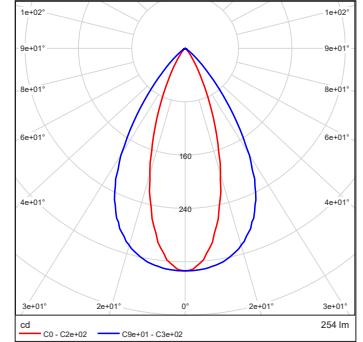

BI-SYMMETRICAL BEAM ANGLES

Bi-symmetrical: 10°x30°, 10°x60°, 35°x70°, 15°x90°

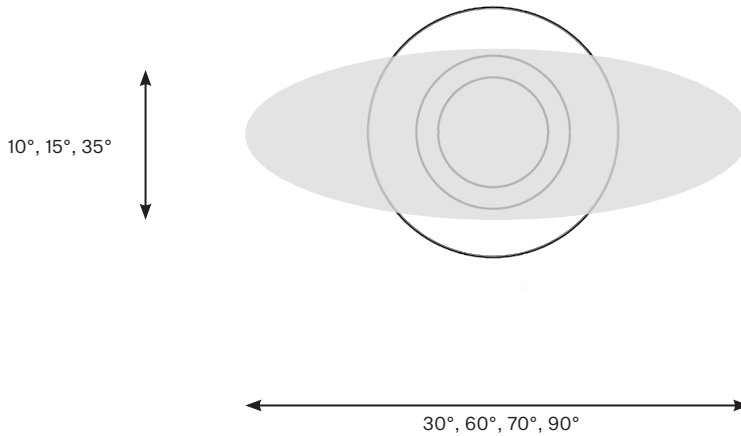

Note: Fixtures with bi-symmetrical beam angles must be set to desired orientation during installation according to actual light flux.

DIMENSIONS

