

E-box Daisy

E-box Star

E-box Lite

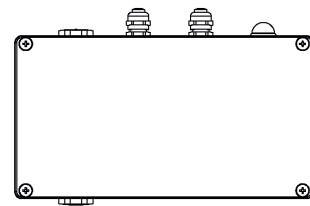
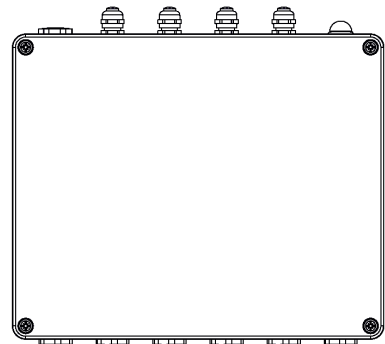
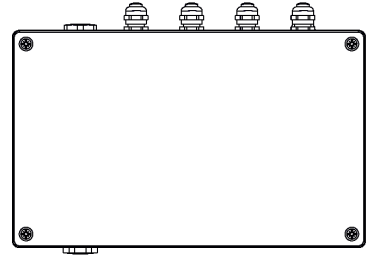

QR code for user manual



E-box Daisy E-box Star E-box Lite

Table of contents

1. Safety information	3
2. Fixture description	4
2.1 E-box Daisy	4
2.2 E-box Star	6
2.3 E-box Pro	8
2.4 E-box Lite	10
3. Mounting	12
4. E-box modes	18
5. E-box menu	21
5.1 DMX Addr	21
5.2 Info	22
5.3 Personality	22
5.4 Test programs.....	23
5.5 Stand Alone.....	23
5.6 Special settings	24
6. Software update	25
7. DMX protocol	26
8. Technical specifications	27
9. Disposing of the product	31
10. ChangeLog	31

1. Safety information

**FOR YOUR OWN SAFETY, PLEASE READ THIS USER MANUAL CAREFULLY
BEFORE POWERING OR INSTALLING YOUR E-BOX!
Save it for future reference.**

DANGEROUS VOLTAGE CONSTITUTING A RISK OF ELECTRIC SHOCK IS PRESENT WITHIN THIS UNIT!

Make sure that the available voltage is not higher than stated on the fixture.

Always disconnect the fixture from AC power before removing its cover.

Make sure that the supply cables are not damaged by sharp edges. Check the fixture and the cables from time to time.

Do not install the fixture near an open flame.

This fixture falls under protection class I. Therefore, this fixture has to be connected to a mains socket outlet with a protective earthing connection.

Do not connect this fixture to a dimmer pack.

Do not cover the fixture with cloth or other materials.

The fixture was designed for outdoor use and it is intended for professional application only. It is not for household use.

When choosing the installation spot, please make sure that the fixture is not exposed to extreme heat or dust.

Only operate the fixture after having checked that the housing is firmly closed and all screws are tightly fastened.

Operate the fixture only after having familiarized yourself with its functions. Do not permit operation by persons not qualified to operate the fixture. Most damages are the result of unprofessional operation!

Please consider that unauthorized modifications on the fixture are forbidden due to safety reasons!

Please use the original packaging if the fixture is to be transported.

If this device will be operated in any way different to the one described in this manual, the product may suffer damages and the warranty becomes void. Furthermore, any other operation may lead to dangers like short-circuit, burns, electric shock etc.

Immunity of the equipment is designed for electromagnetic environments E1, E2, E3 according to the standard EN55103-2 ed.2 Electromagnetic compatibility. Product family standard for audio, video, audiovisual and entertainment lighting control apparatus for professional use. Part 2: Immunity.

The product (covers and cables) must not be exposed to a high frequency electromagnetic field higher than 3V/m

The installation company should check levels of possible interferences above the tested levels E1,E2,E3 given by this standard (e.g. transmitters in surrounding area) before installing the equipment.

Emission of the equipment complies with the standard EN55032 Electromagnetic compatibility of multimedia equipment – Emission Requirements according to class B.

2. Fixture description

2.1 E-box Daisy

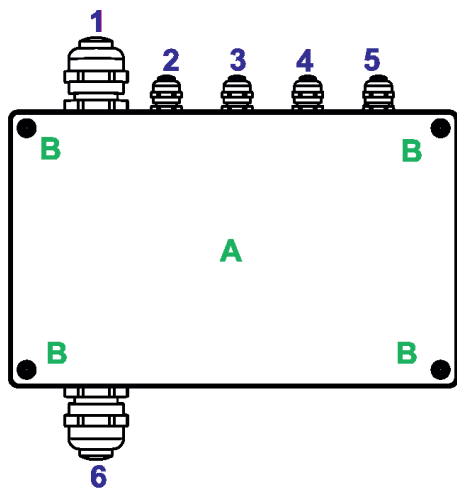

View without top cover

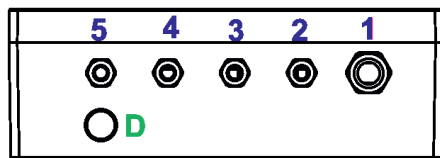
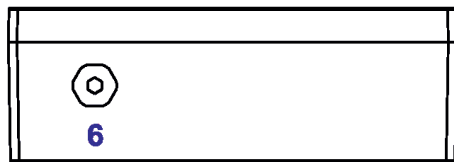
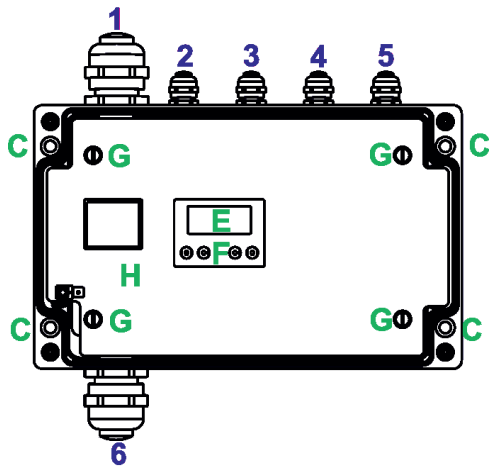

- A - Top cover
- B - Top cover screws
- C - Mounting holes
- D - Antenna cover
- E - Display
- F - Control buttons
- G - Screws of terminal blocks cover
- H - Terminal blocks cover

- 1 - Power IN (cable gland M20x1.5)
- 2 - DMX OUT (cable gland M12x1.5)
- 3 - DMX IN (cable gland M12x1.5)
- 4 - Ethernet OUT (cable gland M12x1.5)
- 5 - Ethernet IN (cable gland M12x1.5)
- 6 - LED Output (cable gland M20x1.5)

E-Box Daisy - connection points

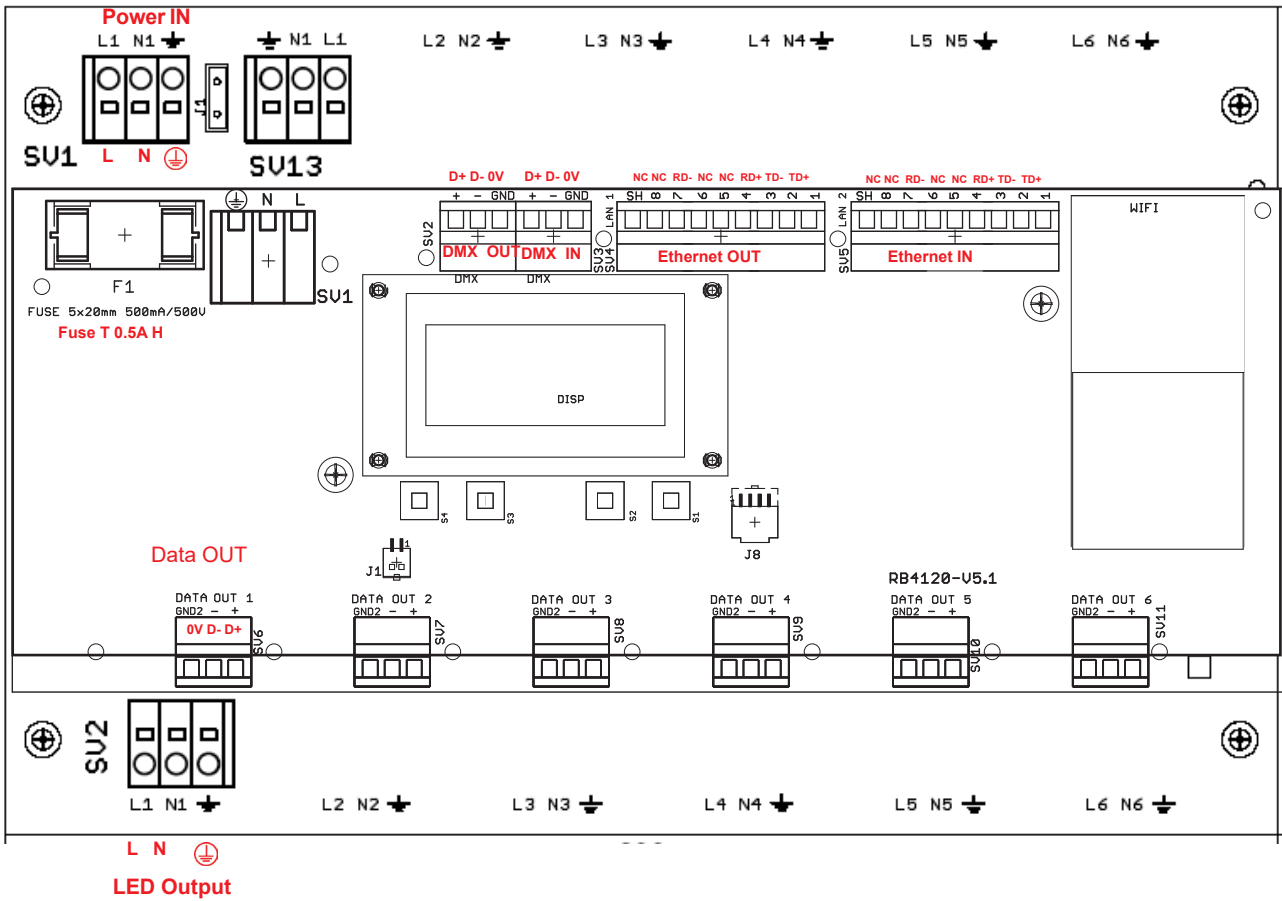

2.2 E-box Star

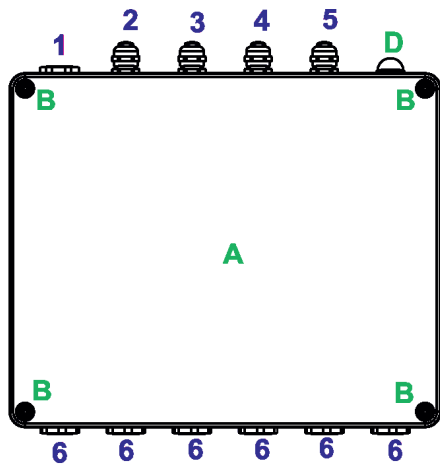

View without top cover

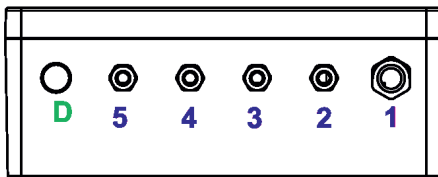
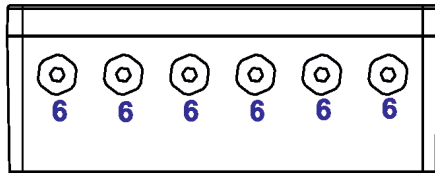
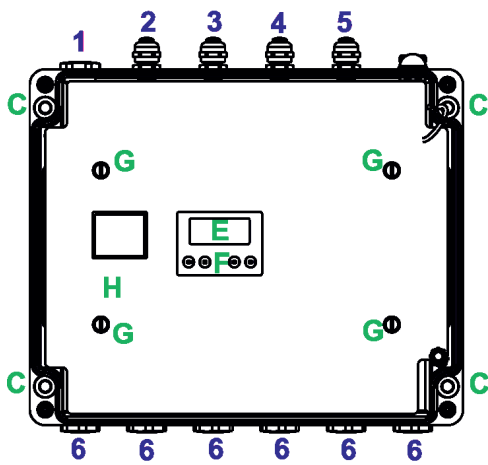

- A - Top cover
- B - Top cover screws
- C - Mounting holes
- D - Antenna cover
- E - Display
- F - Control buttons
- G - Screws of terminal blocks cover
- H - Terminal blocks cover

- 1 - Power IN (filler plug M25 x 1.5/ cable gland M20x1.5)
- 2 - DMX OUT (cable gland M12x1.5)
- 3 - DMX IN (cable gland M12x1.5)
- 4 - Ethernet OUT (cable gland M12x1.5)
- 5 - Ethernet IN (cable gland M12x1.5)
- 6 - LED Outputs (filler plug M25 x 1.5/ cable gland M20x1.5)

E-Box Star - connection points

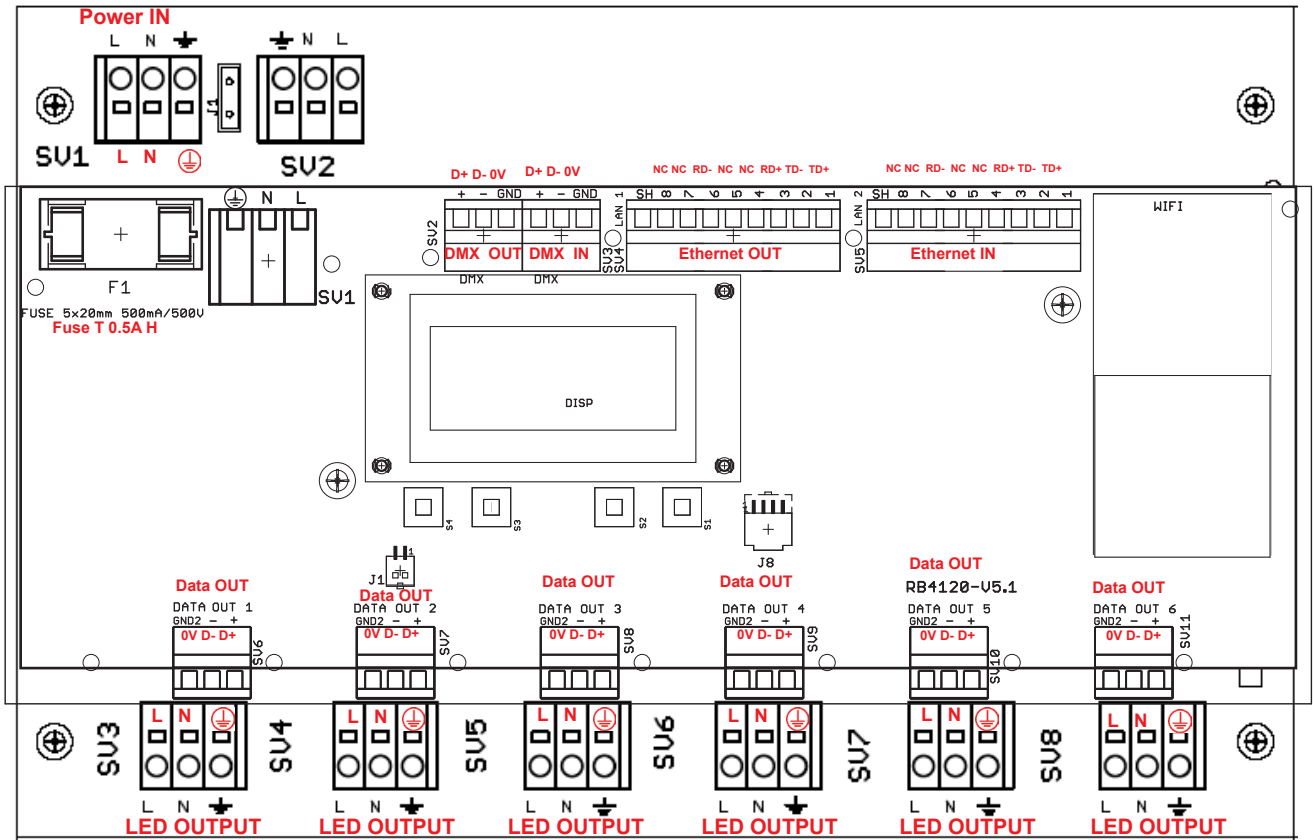

2.4 E-box Lite

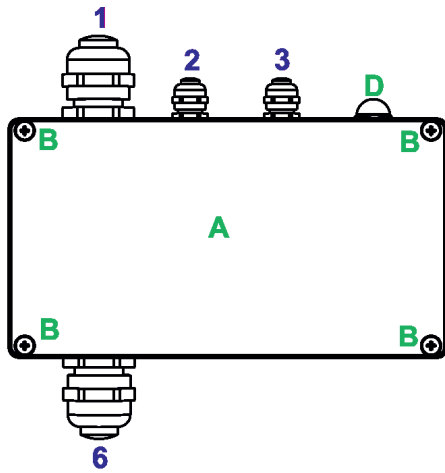

View without top cover

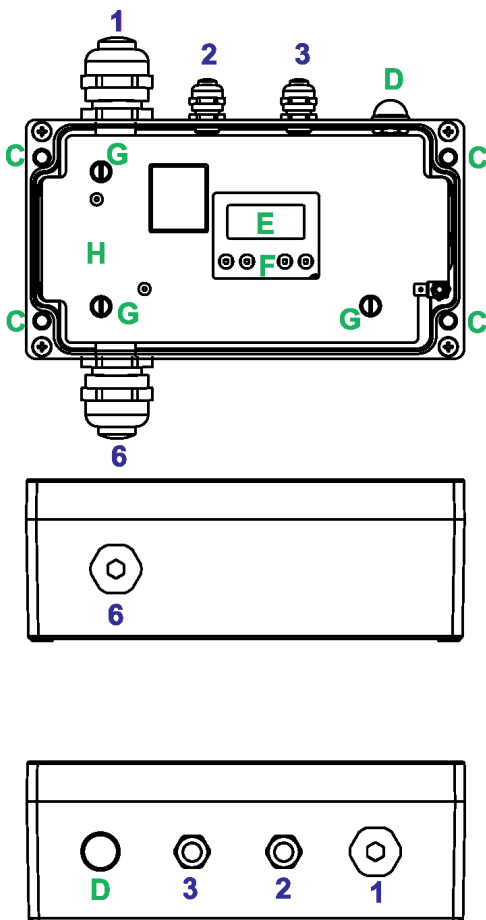

- A - Top cover
- B - Top cover screws
- C - Mounting holes
- D - Antenna cover
- E - Display
- F - Control buttons
- G - Screws of terminal blocks cover
- H - Terminal blocks cover

- 1 - Power IN (cable gland M20x1.5)
- 2 - DMX OUT (cable gland M12x1.5)
- 3 - DMX IN (cable gland M12x1.5)
- 6 - LED Output (cable gland M20x1.5)

E-Box Lite - connection points

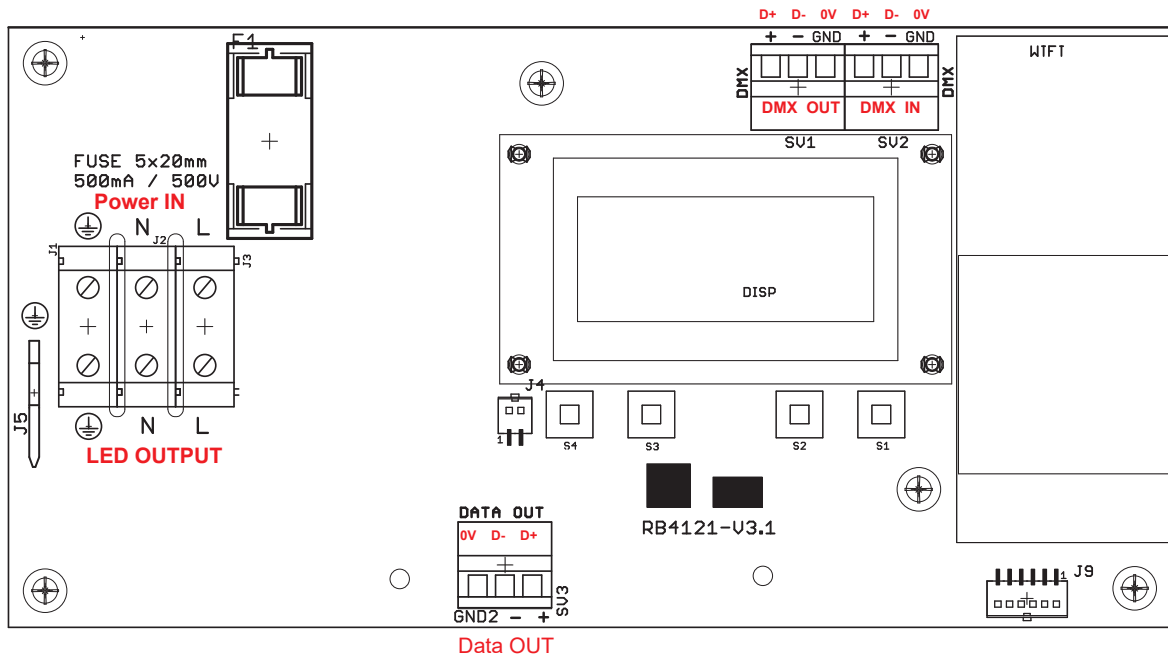

3. Mounting

Fixture must be installed by a qualified electrician in accordance with all national and local electrical and construction codes and regulations.

Setting and addressing the E-box without top cover can be done by a qualified person only!

Note for cable glands.

We recommend to apply an adequate layer of the paste LOCTITE 5331 on the plastic holder of the cable gland before inserting it into the body of the gland and an adequate layer of the paste LOCTITE 577 on the thread of the gland body.

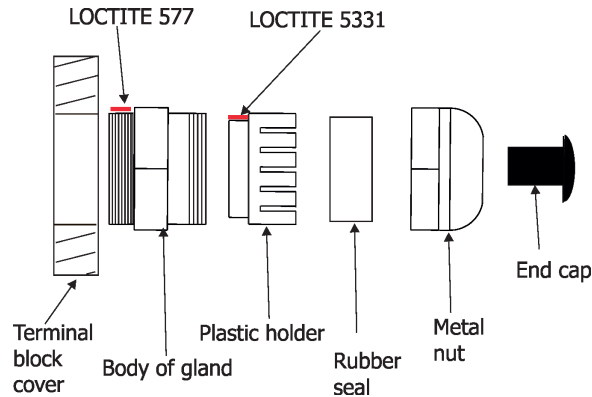

1. Remove the top cover (A) from the E-box by unscrewing four fastening screws (B) in order to get access to the display (E), control buttons (F).
2. Fasten the E-box on a non-flammable flat surface via four mounting holes (C) of a diameter of 6 mm in its housing.
3. Remove the terminal blocks cover (H) from the E-box by unscrewing fastening screws (G) in order to get access to the terminal blocks.
4. Unscrew needed filler plugs M25 x 1.5 (which are installed instead of cable glands M20x1.5) from the housing of the E-box (for E-box Star only) and install cable glands M20x1.5.
5. Pass cables for DMX and Ethernet through cable glands M12x1.5 and connect them to the terminal blocks and tighten the cables in the cable glands.

Note: Remove end caps from cable glands before passing cables. To keep declared IP rating of the device, every cable gland has to be covered with the end cap if the cable gland is not used.

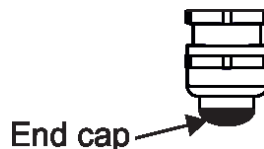

Cable glands serve for cables of the following diameters:

Cable gland M12x1.5 (DMX IN/OUT, Ethernet IN/OUT) - for cable of a diameter of 3-7mm.

Cable gland M20x1.5 (Power IN/ Eminere OUT) - for cable of a diameter of 7-13mm.

6. Check that all screws and cable glands are firmly tightened.
7. Screw the terminal blocks cover (H) back to the E-box.
8. Connect the E-box to mains.
9. Set the E-box by means of the control panel (E) and buttons (F).
10. Disconnect the E-box from mains and screw the cover (A) back on the box.

ALWAYS DISCONNECT THE E-BOX (and BOOSTER BOX) FROM MAINS BEFORE CONNECTING/DISCONNECTING EMINERE MODULES

This device falls under protection class I. Therefore every E-box has to be connected to a mains socket outlet with a protective earthing connection

Power connection

	L	N	PE
Core (EU)	Braun	Blue	Green/yellow
Core (US)	Black	White	Green

DMX connection

D+	D-	0V
Data +	Data -	Data ground (shielding)

Ethernet connection

Pin	1	2	3	4	5	6	7	8
Function	TD+	TD-	RD+	NC	NC	RD-	NC	NC

Eminere connection

Cable CE Leader:

Wire	Power Connection	Wire	Data Connection
Brown	L	Orange	Data -
Blue	N	Purple	Data +
Yellow/Green	⊕ (earth)	Shielding	Data ground (0V)

Cable US Leader:

Wire	Power Connection	Wire	Data Connection
Black	L	Orange	Data -
White	N	Red	Data +
Green	⊕ (earth)	Shielding	Data ground (0V)

Note for Emineres only! The wiring stated above applies to the Emineres marked X on their labels only. Older versions of Emineres have swapped wires Data - and Data+ (Orange wire= Data +, Red/Purple wire= Data -) and do not have mark X on their labels.

Example:



This note does not apply for Emineres Side and Emineres Inground

Example of connection

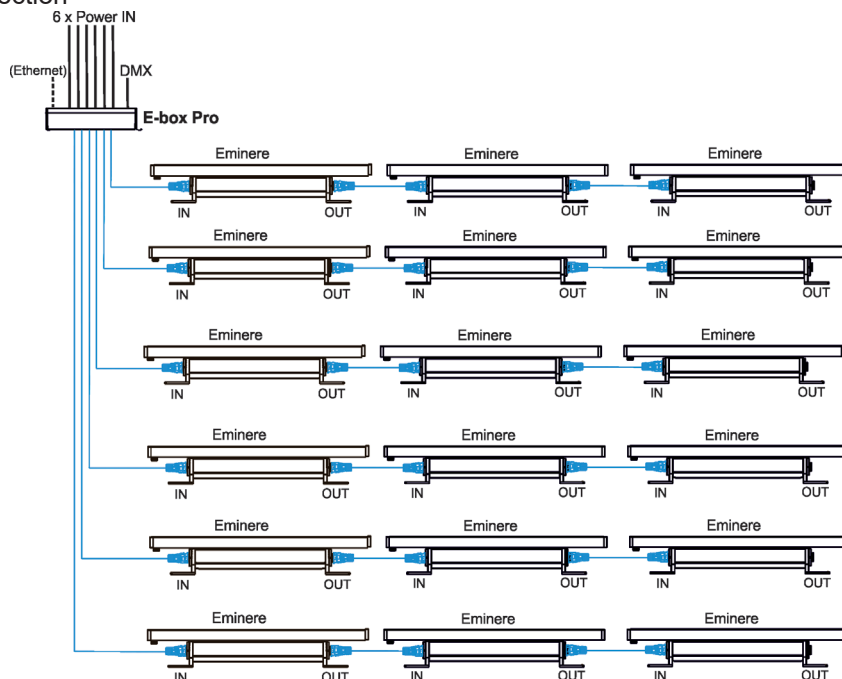

Number of connected Emineres to one LED output of the E-box depends on a cable length, power voltage, type of Eminere and type of E-box and operation mode.

The tables below state max. theoretical number of Emineres connected to the one LED output of the E-box without using Booster boxes. Number of Emineres depends on voltage and cable length.

The following tables apply for the Standard mode of E-boxes.

EMINERE 1(Eminere Side 1)	Voltage			
	120V	190V	230V	277V
Cable length *				
10 m	83	131	159	191
20 m	83	131	159	191
30 m	58	131	159	191
50 m	35	88	128	186
70 m	25	63	92	133
100 m	17	44	64	93
200 m	9	22	32	47

EMINERE 2(Eminere Side 2)	Voltage			
	120V	190V	230V	277V
Cable length *				
10 m	41	64	78	94
20 m	41	64	78	94
30 m	28	64	78	94
50 m	17	43	63	91
70 m	12	31	45	65
100 m	9	21	31	46
200 m	4	11	16	23

EMINERE 3(Eminere Side 3)	Voltage			
	120V	190V	230V	277V
Cable length *				
10 m	28	44	53	64
20 m	28	44	53	64
30 m	19	44	53	64
50 m	12	29	43	62
70 m	8	21	31	44
100 m	6	15	21	31
200 m	3	7	11	16

EMINERE 4 (Eminere Side 4)	Voltage			
	120V	190V	230V	277V
Cable length *				
10 m	21	33	40	48
20 m	21	33	40	48
30 m	15	33	40	48
50 m	9	22	32	47
70 m	6	16	23	38
100 m	4	11	16	23
200 m	2	5	8	12

* Cable length is a total cable length between E-box and last connected Eminere.

Example: Total cable length=L1+L2+L3

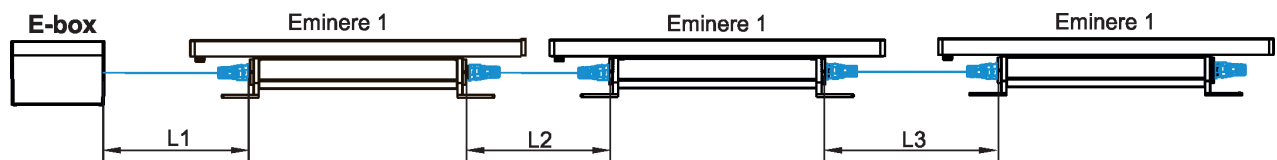

Important note for E-box Star

The tables for Standard and Pass-Thr mode mode state max. total number of Emineres connected to 6 LED outputs of the E-box Star (or max. number of Emineres connected to one LED output if the rest of LED outputs are not connected). The E-box Star has only one power input!

Example 1:

E-box Star, voltage=230V, cable length=100m, fixture= Eminere 4, total. number of Emineres 4 =16 pcs, without Booster box, Standard mode.

LED Output 1 =4 x Eminere 4

LED Output 2 =4 x Eminere 4

LED Output 3 =4 x Eminere 4

LED Output 4 =4 x Eminere 4

LED Output 5 =not connected

LED Output 6 =not connected

LED Outputs 5 and 6 are free, otherwise max. number of 16 pieces of Eminere 4 will be exceeded.

Example 2:

E-box Star, voltage=230V, cable length=100m, fixture= Eminere 4, total number of Emineres 4 =16 pcs, without Booster box, Standard mode.

LED Output 1 =16 x Eminere 4 LED Output 2 = not connected LED Output 3 = not connected

LED Output 4 = not connected LED Output 5 =not connected LED Output 6 =not connected

Outputs 2,3,4,5,6 to Eminere are free because the max. number of 16 pieces of the Eminere 4 is connected to the output 1.

The following tables apply for the Pass-Thr mode of E-boxes

EMINERE 1(Eminere Side 1)	Voltage			
	120V	190V	230V	277V
Cable length *				
10 m	32	32	32	32
20 m	32	32	32	32
30 m	32	32	32	32
50 m	32	32	32	32
70 m	25	32	32	32
100 m	17	32	32	32

EMINERE 2(Eminere Side 2, Eminere Inground 2)	Voltage			
	120V	190V	230V	277V
Cable length *				
10 m	32	32	32	32
20 m	32	32	32	32
30 m	28	32	32	32
50 m	17	32	32	32
70 m	12	31	32	32
100 m	9	21	32	32

EMINERE 3(Eminere Side 3)	Voltage			
	120V	190V	230V	277V
Cable length *				
10 m	28	32	32	32
20 m	28	32	32	32
30 m	19	32	32	32
50 m	12	29	32	32
70 m	8	21	31	32
100 m	6	15	21	31

EMINERE 4(Eminere Side 4, Eminere Inground 4)	Voltage			
	120V	190V	230V	277V
Cable length *				
10 m	21	32	32	32
20 m	21	32	32	32
30 m	15	32	32	32
50 m	9	22	32	32
70 m	6	16	23	32
100 m	4	11	16	23

* Cable length is a total cable length between E-box and last connected Eminere.

Example for Eminere Inground: Total cable length= L1+ΣL2+ΣL3.

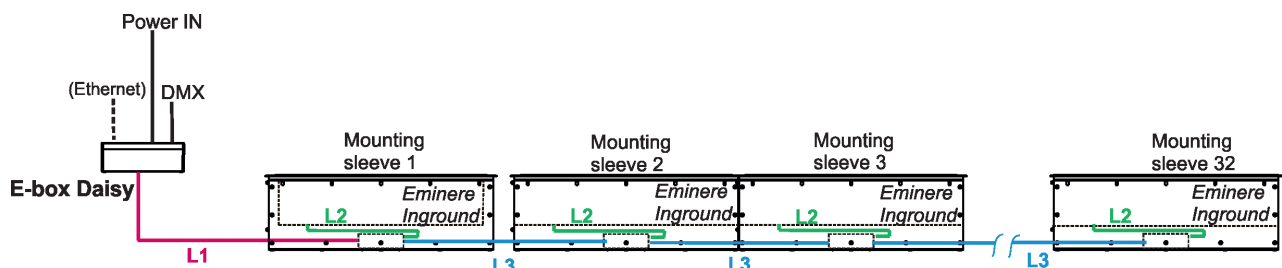

The Booster box

To compensate a voltage drop in a large installation, the Booster boxes have to be connected in the chain of Eminere modules.

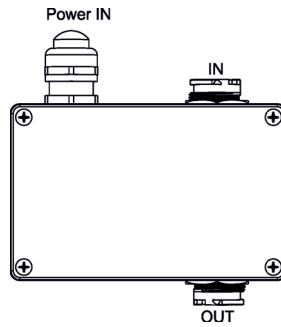

Example: E-box Daisy, Power supply= 230V, Total cable length=70m, Standard mode, type of Eminere: Eminere 2
The Booster box has to be connected after every 45th Eminere 2 (fixture 45 and fixture 90 from 94 fixtures).

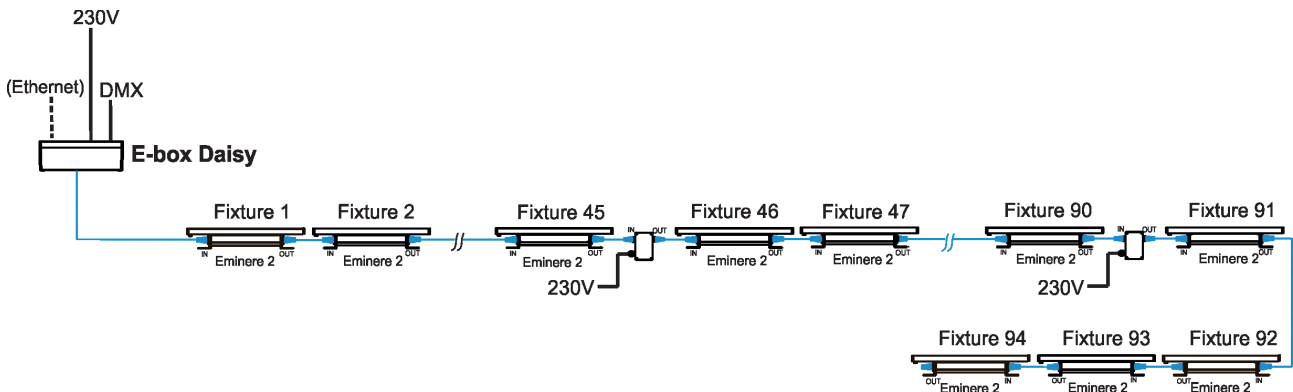

The following tables give numbers of Emineres after which the Booster box has to be installed in the chain of Emineres.

Tables for Standard mode

Eminere 1 Eminere Side 1	Max. possible number of Emineres 1= 191			
	Voltage			
Cable length	120V	190V	230V	277V
10 m	83,166	131	159	-
20 m	83,166	131	159	-
30 m	58,116,174	131	159	-
50 m	35,70,105,140,175	88,176	128	186
70 m	25,50,75,100,125,150,175	63,126,189	92,184	133
100 m	17,34,51,68,85,102,119,136, 153,170,187	44,88,132,176	64,128	93,186
200 m	9,18,27,36,45,54,60,72,81 90,99,108,117,126,135,144,153, 162,171,180,189,	22,44,66,88,110, 132,154,176	32,64,96,128,160	47,94, 141,188

EMINERE 2 Eminere Side 2	Max. possible number of Emineres 2= 94			
	Voltage			
Cable length	120V	190V	230V	277V
10 m	41,82	64	78	-
20 m	41,82	64	78	-
30 m	28,56,84	64	78	-
50 m	17,34,51,68,85	43,86	63	91
70 m	12,24,36,48,60,72,84	31,62,93	45,90	65
100 m	9,18,27,36,45,54,60,72,81,90	21,42,63,84	31,62,93	46,92

200 m	4,8,12,16,20,24,28,32,36,40, 44,48,52,56,60,64,68,72,76,80 ,84,88,92	11,22,33,44,55,66, 77,88	16,32,48,64,80	23,46,69,92
-------	--	-----------------------------	----------------	-------------

Eminere 3 Eminere Side 3	Max. possible number of Emineres 3= 64			
	Voltage			
Cable length	120V	190V	230V	277V
10 m	28,56	44	53	-
20 m	28,56	44	53	-
30 m	19,38,57	44	53	-
50 m	12,24,36,48,60	29,58	43	62
70 m	8,16,24,32,40,48,56	21,42,63	31,62	44
100 m	6,12,18,24,30,36,42,48,54,60	15,30,45,60	21,42,63	31,62
200 m	3,6,9,12,15,18,21,24,27,30, 33,36,39,42,45,48,51,54,57, 60,63	7,14,21,28,35,42,49 56,63	11,22,33,44,55	16,32,48,

Eminere 4 Eminere Side 4	Max. possible number of Emineres 4= 48			
	Voltage			
Cable length	120V	190V	230V	277V
10 m	21,42	33	40	-
20 m	21,42	33	40	-
30 m	15,30,45	33	40	-
50 m	9,18,27,36,45	22,44	32	47
70 m	6,12,18,24,30,36,42	16,32	23,46	38
100 m	4,8,12,16,20,24,28,32,36,40,44	11,22,33,44	16,32	23,46
200 m	2,4,6,8,10,12,14,16,18,20,22,24, 26,28,30,32,34,36,38,40, 42,44,46	5,10,15,20,25,30, 35,40,45	8,16,24,32,40	12,24,36

Please see the Eminere user manual for more information about the Booster box installation.

Tables for Pass-Thru mode

EMINERE 1 Eminere Side 1	Max. possible number of Emineres 1= 32			
	Voltage			
Cable length	120V	190V	230V	277V
10 m	-	-	-	-
20 m	-	-	-	-
30 m	-	-	-	-
50 m	-	-	-	-
70 m	25	-	-	-
100 m	17	-	-	-

EMINERE 2 Eminere Side 2 Eminere Inground 2	Max. possible number of Emineres 2= 32			
	Voltage			
Cable length	120V	190V	230V	277V
10 m	-	-	-	-
20 m	-	-	-	-
30 m	28	-	-	-
50 m	17	-	-	-
70 m	12,24,	31	-	-
100 m	9,18	21	31	-

EMINERE 3 Eminere Side 3	Max. possible number of Emineres 3= 32			
	Voltage			
Cable length	120V	190V	230V	277V
10 m	28	-	-	-
20 m	28	-	-	-
30 m	19	-	-	-
50 m	12,24	29	-	-
70 m	8,16,24	21	31.	-
100 m	6,12,18,24,30	15,30	21	31

EMINERE 4 Eminere Side 4 Eminere Inground 4	Max. possible number of Emineres 4= 32			
	Voltage			
Cable length	120V	190V	230V	277V
10 m	21	-	-	-
20 m	21	-	-	-
30 m	15,30	-	-	-
50 m	9,18,27	22	-	-
70 m	6,12,18,24,30	16	23	-
100 m	4,8,12,16,20,24,28	11,22	16	23

4. E-box modes

The E-box menu allows you to switch connected LED modules to the two modes:

Standard - LED modules are switched to an internal serial connection. DMX addressing of connected LED modules is made automatically (default values are: DMX address=1, DMX Preset = 1 IPix Mode), changes can be done by the E-box menu (item Set DMX Address and item DMX Preset). The Standard mode is set as default. The Emineres and Emineres Side can be switched to the Standard or to the Pass-Thr mode

Pass-Thr - LED modules are switched to an internal parallel connection. This mode is primarily intended for Emineres Inground. DMX addressing of connected LED modules has to be done manually by means of the Robe Universal Interface (or its wireless version Robe Universal Interface WTX) and the software RDM Manager. The Emineres Inground can be switched to the Pass -Thr mode only.

Example of the Emineres Inground connection for their addressing.

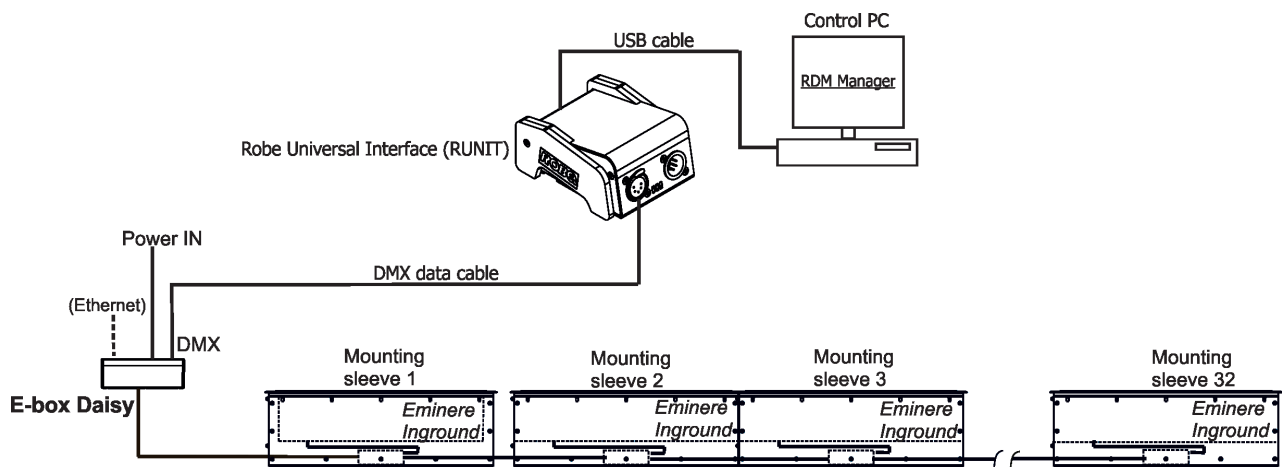

Note: RDM manager and DMX controller cannot run in the same time.

Examples of RDM manager screenshots for one connected LED module.
Initial screen of the RDM manager:

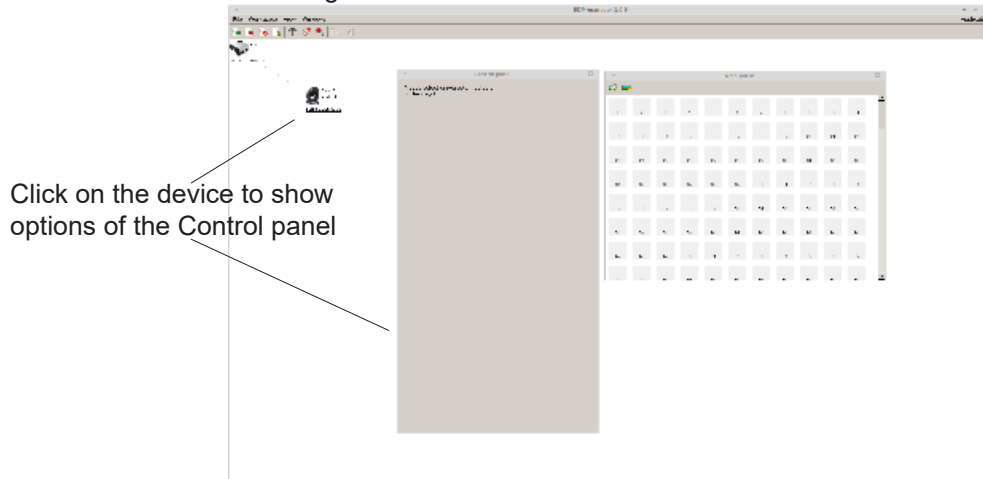

Options in the Control panel allows you to set DMX address and Personality for each LED module.

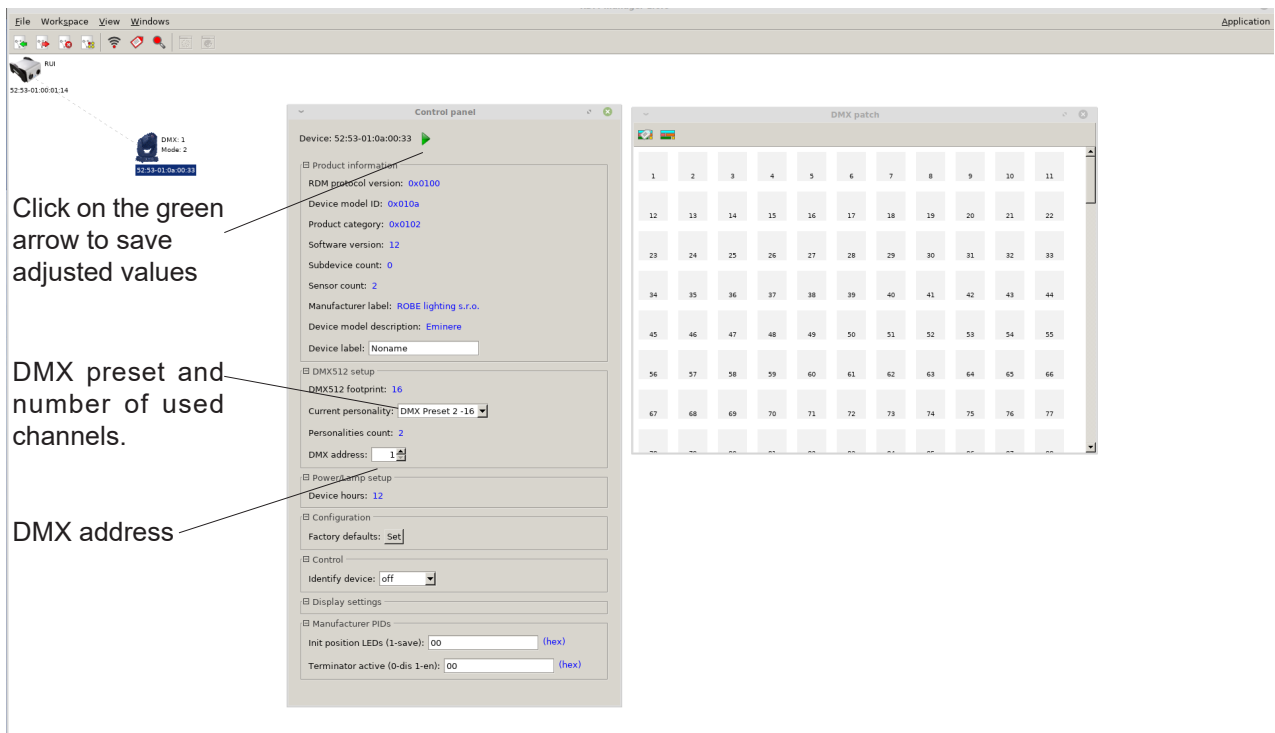

Occupied channels are displayed in the window DMX patch on the right side of the Control panel.

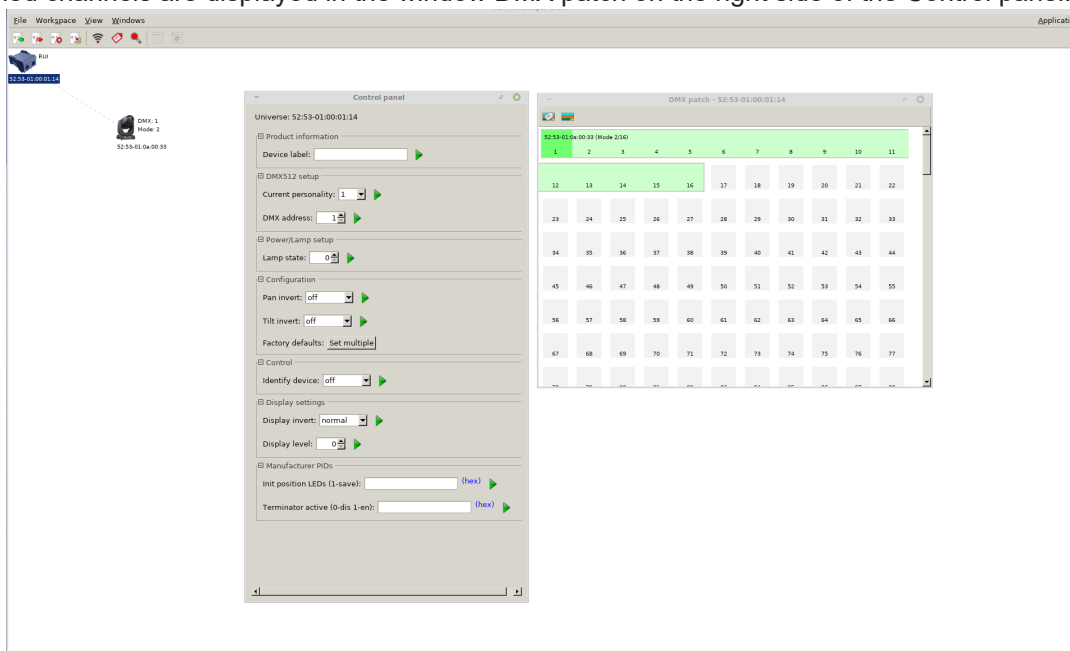

Possible numbers of connected LED modules for each E-box mode is stated in the chapter "3. Mounting".

If no DMX is received, the product will turn on the predefined Demo mode. You can disable it by setting the unit to a desired look via DMX and then save this via RDM by setting the "Init position LEDs" to 1:

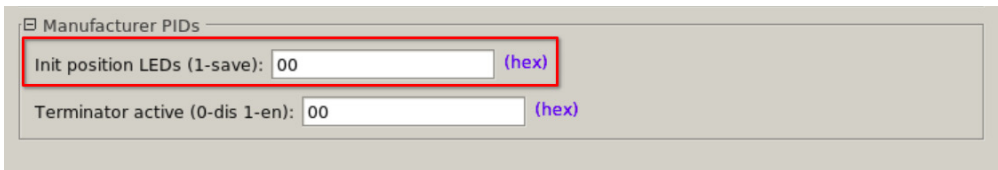

Manufacturer PIDs

Init position LEDs (1-save): (hex)

Terminator active (0-dis 1-en): (hex)

Detailed description: This is a screenshot of a control panel for 'Manufacturer PIDs'. It contains two input fields. The first field is labeled 'Init position LEDs (1-save):' and contains the value '00'. The second field is labeled 'Terminator active (0-dis 1-en):' and also contains the value '00'. Both fields have a '(hex)' label to their right. A red rectangular box highlights the first field.

Last Eminere on the DMX chain should be terminated by setting the "Terminator active" to 1:

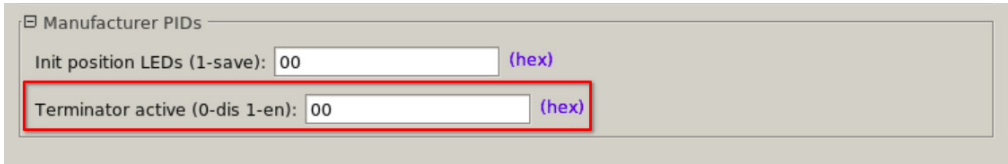

Manufacturer PIDs

Init position LEDs (1-save): (hex)

Terminator active (0-dis 1-en): (hex)

Detailed description: This is a screenshot of a control panel for 'Manufacturer PIDs', identical to the one above. It contains two input fields. The first field is labeled 'Init position LEDs (1-save):' and contains the value '00'. The second field is labeled 'Terminator active (0-dis 1-en):' and also contains the value '00'. Both fields have a '(hex)' label to their right. A red rectangular box highlights the second field.

5. E-box menu

The E-box is equipped with 2-row LCD display and four buttons which allows to address the fixture and set the fixture's behaviour according to your needs.

The four control buttons have the following functions:

↖ - ESCAPE button- to escape function or menu.

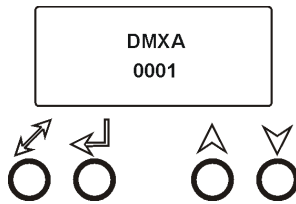

↵ - ENTER button- to select a function or confirm adjusted value.

▲, ▼ - UP and DOWN buttons - to move within the menu.

When you change any setting of the E-box, disconnect the E-box from power and connect it to power again to activate changes which you have made.

The connected LED modules can be operated in two modes (menu Special-->E-box mode):

Standard - intended for Emineres and Emineres Side

Pass- Thr - intended for Emineres Inground, Emineres and Emineres Side.

Emineres Inground can be operated in the Pass-Thr mode only!

Some menu items are not accessible if the option Pass-Thr is selected from the menu E-box mode (menu Personality).

These menu items are marked by # in the article below.

5.1 DMX Addr

Set DMX Address - use this menu item to set the DMX start address of the fixture, which is defined as the first channel from which the E-box will respond to a DMX controller.

Note: if the option Pass-Thr is selected from the menu E-box mode, the sign "Pass-Thr" is displayed instead of the sign "DMX Addr" and the menu item Set DMX Address is not available.

IP address* - select this menu item to set desired IP address. IP address is the Internet protocol address. The IP uniquely identifies any node (fixture) on a network. There cannot be 2 fixtures with the same IP address on the network!

Default Address. This address is derived from fixture's MAC address and cannot be changed. Confirm the item **"Set Address"** to select this address.

Custom Address. IP address consists of four decimal numbers, each ranging from 0 to 255, separated by dots, e.g., 172.16.254.1. Each part represents a group of 8 bits (octet) of the address.

The following items **"IP Adr 1"**, **"IP Adr 2"**, **"IP Adr 3"**, **"IP Adr 4"** allow you to set each part (number) of the address. After setting desired IP address, confirm the item **"Set Address"** to save this address.

Network mask* - select this menu item to set desired network mask. A network mask is a 32-bit mask used to divide an IP address into subnets and specify the networks available hosts.

The following items **"Net M.1"**, **"Net.M.2"**, **"Net.M.3"**, **"Net.M.4"** serve for setting of each part (number) of the net mask.

After setting desired network mask, confirm the item **"Set Net M."** to save adjusted values.

* E-box Daisy, E-box Star only.

5.2 Info

Use this menu to read useful information about the fixture.

Software version - select this menu item to read software versions of the E-box and connected Emineres.

Databox - version of the E-box.

PWR-1 v1 - version of connected Emineres. If the connected Emineres have two or more versions, the items **v2**, **v3**.... will appear in the menu and you should to update the software in Emineres to the latest version.

WL - version of installed wireless DMX module.

IP Addr - - **IP address**. This menu item shows the current IP address (the IP address "runs" on display).

RDM UID - - **RDM UID**. Select this menu item to read the RDM UID (the RDM UID "runs" on display).

MAC Addr - - **MAC Address**. Select this menu item to read the MAC address (the MAC address "runs" on display).

Outputs Info - information about Emineres connected to the LED outputs.

Example:

Output 1 Infoinformation about E-box output 1

Fixtures Cnt: 12.....Number of connected Emineres to the selected output.

Footp. 192.....Footprint (number of used channels depends on setting in the menu "DMX Preset" - for Standard mode).

If some Eminere output is not used, the message "No output" will be displayed.

Temp - **Temperature**. Temperature inside the E-box.

5.3 Personality

Use this menu to modify the E-box operating behaviour.

DMX Preset - DMX preset. Use the menu to select desired Eminere channel mode. The menu item is accessible for Standard mode only (menu E-box mode).

Total - Total mode. All connected Emineres at all outputs behave as one pixel and they are controlled together.

Fixture - Fixture mode. Each connected Eminere behaves as one pixel.

Pixel - Pixel mode. 12 LEDs of Eminere create one pixel (Eminere 1).

Output - Output mode. All connected Emineres at one output behave as one pixel and they are controlled together

DMX Input - this menu allows you to choose desired DMX data input:

Wired DMX - DMX signal is received by means of the standard DMX cable.

Wireless* - DMX signal is received by means of the inbuilt wireless DMX module.

Wireless Out DMX*- the fixture receives wireless DMX and sends the signal to its wired DMX output.
The fixture behaves as a " Wireless/Wired" adapter.

Ethernet** - DMX signal is received by means of the Ethernet cable.

* If wireless DMX module is installed.

** E-box Daisy, E-box Star only.

Ethernet Settings** - use the menu item to select and set desired operating mode.

Ethernet mode - use the menu to select a protocol.

Artnet - fixture receives Artnet protocol

sACN - fixture receives sACN protoco

gMAI - fixture receives MANet 1 protocol

gMAII - fixture receives MANet 2 protocol

ArtNet Settings - use the menu item to set parameters for ArtNet operation.

ArtNet Uni. 1 - selection of the ArtNet Universe (1-12)

Net - selection of a network (0-127)

Sub-Net - selection of a subnet (0-15).

Universe - selection of an Universe (0-15).

Menu items "ArtNet Uni. 1 " and "Universe" allow a "crossing of Universes".

sACN Settings - use the menu item to set parameters for sACN operation.

sACN Uni - selection of the sACN Universe (1-12). To the selected universe can be assigned universe from range of 1-63999. It allows a "crossing of Universes".

MANet Settings - Use this menu to set parameters for MANet operation.

MA. Uni - MANet I (II) universe. The value of this item can be set in range of 1-256.

MA. S. ID - MANet I(II) session ID. The value of this item can be set in range of 1-32.

IGMP rep - Repeating time for Internet Group Management Protocol (Off, 1s-10s).

** E-box Daisy, E-box Star only.

Display Settings - this menu allows you to change the display settings.

Display Off Timer - if this item is on, the display will be switched off 2 minutes after last pressing any button on the control panel.

Display Lightness - select this menu item to adjust the display intensity (0-100%).

Display Contrast - select this menu item to adjust contrast of the display (0-100%).

RGB(W) Split - this menu item allows you to select a way how the last pixel of the actual DMX Universe will be split to the next DMX Universe if the actual DMX Universe does not offer enough free channels for the pixel. (DMX Universe= set of 512 channels). The menu item does not function for Emineres Inground.

Disabled - pixel will be moved to another DMX Universe. Some channels will stay unused.

Enabled - pixel will use channels of actual DMX Universe and also channels of next DMX Universe. All channels of the actual DMX Universe will be used.

Input Data - this menu item allows you to select a type of input data.

RGBW - fixture receives RGBW data

RGB - fixture receives RGB data, white colour of connected Emineres is proportionally counted.

DMX Hold - If the function is on, the fixture keeps last received DMX values in case that DMX data receiving was interrupted (e.g. disconnected DMX cable or DMX controller).

E-box mode - this menu item allows you to select a way of Emineres connection.

Standard - Emineres are switched to the internal serial connection

Pass-Thr - Emineres are switched to the internal parallel connection. This option has to be set if the Eminere Inground modules are connected to the E-box.

The Emineres and Emineres Side can be switched to the Standard or to the Pass-Thr mode

The Emineres Inground can be switched to the Pass -Thr mode only.

Important. Switch Off/On the E-box after changing the E-box mode.

Default setting - select this option to set fixture personalities to the default (factory) values.

5.4 Test programs

Use the menu to run a test sequences without an external controller, which will show you some possibilities of using the E-box in conjunction with LED modules.

Colors - runs a colour changing of all LEDs in a loop (Standard mode has to be selected from the menu E-box mode)

Pixels - runs a pixel program in a loop (Standard mode has to be selected from the menu E-box mode, number of pixels depends on setting in the menu DMX Preset).

5.5 Stand Alone

The fixtures on a data link are not connected to the controller but can execute pre-set program.

Important: LED modules have to be connected to the E-box and the Standard mode has to be selected from the menu E-box mode.

Auto Run - This function allows you to select a program which will be played in the stand-alone mode after switching the fixture on. Selected program will be played continuously in a loop.

Off - The option disables Auto Run function.

Test C - the option runs a colour changing on connected LED modules.

Test P - the option runs a pixel program on connected LED modules.

User - the option runs a user-defined program

Program Play - Select this menu item to run the user-defined program in a loop.

Program Edit - Select this menu to create or edit the user defined program. The E-box offers one user-defined program up to 50 steps. Each program step has a step time - the time during which effects last in the current step.

To program connected LED modules:

Procedure of programming depends on selected item in the menu DMX Preset (Personality--> DMX Preset).

DMX Preset=Fixture

You can program separately each E-box output and separately each LED module on each E-box output.

1. Press UP or DOWN buttons to select the menu Program Edit and press the ENTER button. The item S. Count (Step Count) will appear.
2. Press the ENTER button and set desired number of steps by means of UP/DOWN buttons and press the ENTER button.
3. Select desired step by means of UP/DOWN buttons, press the ENTER button and use UP/DOWN buttons to select the item Step tim and press the ENTER button to set step time by means of UP/DOWN buttons. Confirm by pressing the ENTER button.
4. Use UP/DOWN buttons to select Output 1 and press the ENTER button.
5. Use the UP/DOWN buttons to select Fixture 1 and press the ENTER button.
6. Use the UP/DOWN buttons to select desired colour (Red, Green, Blue,White), press the ENTER button and set desired value by means of the UP/DOWN buttons, Confirm by the ENTER button.
7. Press the ESCAPE button and repeat steps 4-6 for each fixture on each output of the E-box.

DMX Preset=Output

You can program separately each E-box output. LED modules on each E-box output are programmed together.

1. Press UP or DOWN buttons to select the menu Program Edit and press the ENTER button. The item S. Count (Step Count) will appear.
2. Press the ENTER button and set desired number of steps by means of UP/DOWN buttons and press the ENTER button.
3. Select desired step by means of UP/DOWN buttons, press the ENTER button and use UP/DOWN buttons to select the item Step tim and press the ENTER button to set step time by means of UP/DOWN buttons. Confirm by pressing the ENTER button.
4. Use UP/DOWN buttons to select Output 1 and press the ENTER button.
5. Use the UP/DOWN buttons to select desired colour (Red, Green, Blue,White), press the ENTER button and set desired value by means of the UP/DOWN buttons, Confirm by the ENTER button.
6. Press the ESCAPE button and repeat steps 4-5 for each output of the E-box.

DMX Preset=Total

All outputs of the E-box are programmed together (including LED modules)

1. Press UP or DOWN buttons to select the menu Program Edit and press the ENTER button. The item S. Count (Step Count) will appear.
2. Press the ENTER button and set desired number of steps by means of UP/DOWN buttons and press the ENTER button.
3. Select desired step by means of UP/DOWN buttons, press the ENTER button and use UP/DOWN buttons to select the item Step tim and press the ENTER button to set step time by means of UP/DOWN buttons. Confirm by pressing the ENTER button.
4. Use the UP/DOWN buttons to select desired colour (Red, Green, Blue,White), press the ENTER button and set desired value by means of the UP/DOWN buttons, Confirm by the ENTER button.

5.6 Special settings

Wireless* - **Wireless DMX information.** The menu allows to read some information about Wireless DMX operation

Stat - **Wireless status.** Use the menu to read wireless DMX status.

Unlink - use this item to unlink the fixture from wireless DMX.

* If wireless DMX module is installed.

Software Update - The menu item switches the the E-box to the update mode.

6. Software update

E-box software update is done via an Ethernet connection between a computer running a ROBE Uploader software and E-box or using the Robe Universal Interface (Robe Universal Interface WTX) and the ROBE RDM Uploader software.

The ROBE Uploader is a software for automatized software update of ROBE fixtures. The ROBE Uploader switches E-box to the update mode automatically.

Please see <https://www.robe.cz/robe-uploader/> for more information about the ROBE Uploader.

Examples of connections for software update:

1. By means of the Ethernet connection

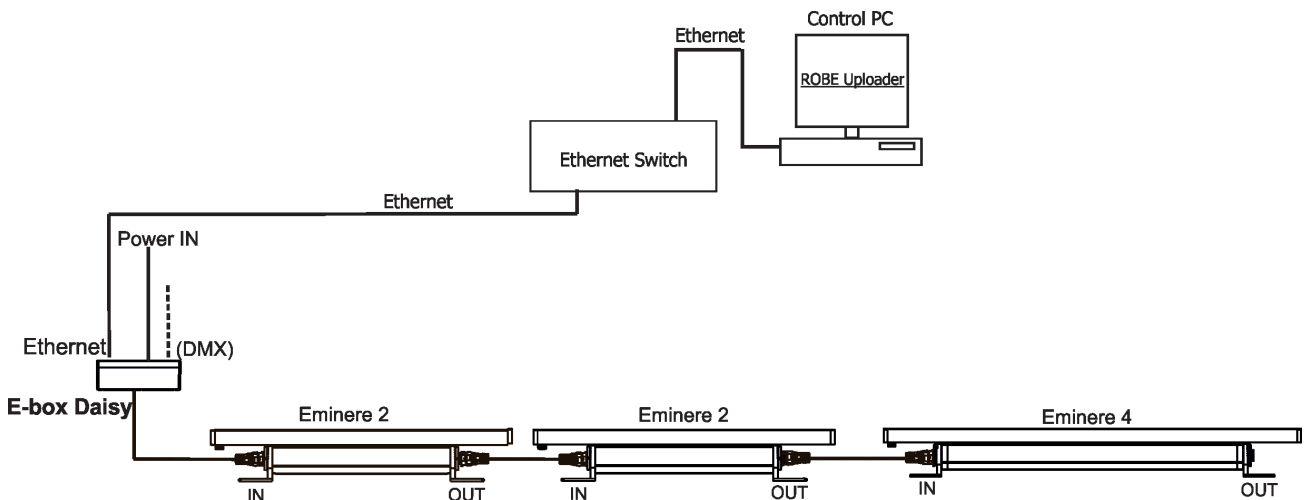

2. By means of the Robe Universal Interface (Robe Universal Interface WTX)

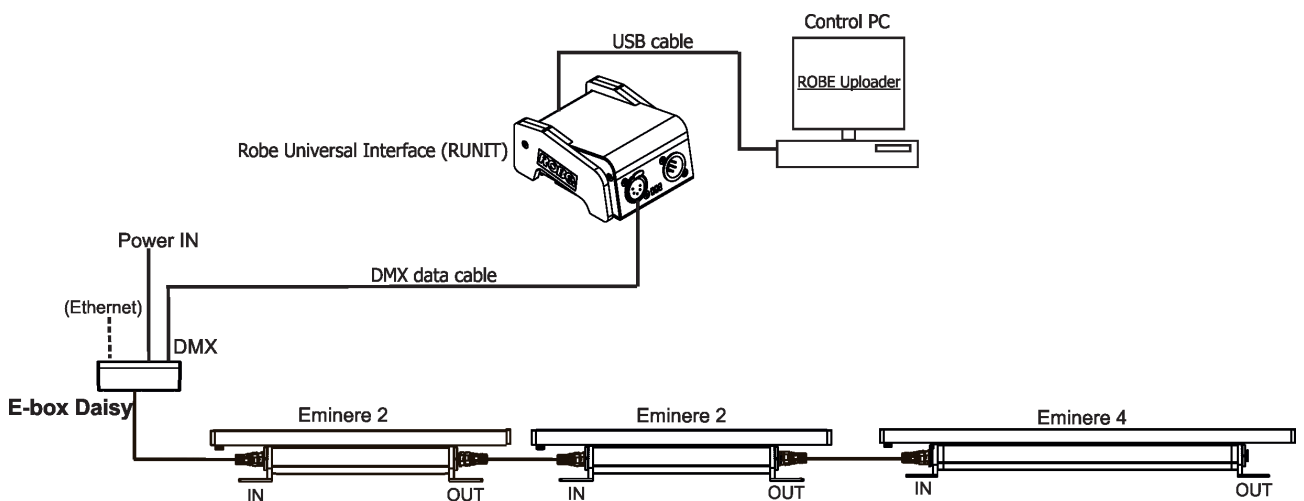

Note: If the option Standard is selected from the menu E-box mode, the E-box will be updated including connected Eminere modules.

If the option Pass-Thr is selected from the menu E-box mode, the E-box will not be updated, only connected Eminere modules.

7. DMX protocol

Version 1.0

Channel	DMX Value	Function	Type of control
1	0-255	Red LEDs (Pixel 1) Red LEDs saturation control (0-100%)	proportional
2	0-255	Green LEDs (Pixel 1) Green LEDs saturation control (0-100%)	proportional
3	0-255	Blue LEDs (Pixel 1) Blue LEDs saturation control (0-100%)	proportional
4	0-255	White LEDs (Pixel 1) White LEDs saturation control (0-100%)	proportional
5	0-255	Red LEDs (Pixel 2) Red LEDs saturation control (0-100%)	proportional
6	0-255	Green LEDs (Pixel 2) Green LEDs saturation control (0-100%)	proportional
7	0-255	Blue LEDs (Pixel 2) Blue LEDs saturation control (0-100%)	proportional
8	0-255	White LEDs (Pixel 2) White LEDs saturation control (0-100%)	proportional
:	:	:	:
depends on number of pixels N	0-255	White LEDs (Pixel N) White LEDs saturation control (0-100%)	proportional

8. Technical specifications

E-box Daisy

Number of inputs:	1
Input voltage	120-277 V AC; 50/60Hz
Power consumption	5W (self-consumption of the E-box)
Fuse	T 0.5A H
LED Output	
Number of outputs	1
Voltage	120-277 V
Max. Current	16A
Control	2-row LCD display & 4 buttons
Supported protocols	USITT DMX 512, ArtNet, sACN, RDM
W-DMX control (optional)	
Connection	
Power IN	terminal block Phoenix 2 SPT_2.5/3-V-5.0
Ethernet IN/OUT	terminal block Phoenix SPTAF_1/9-3.5
DMX IN/OUT	terminal block Phoenix SPTAF 1/3-3,5
LED Output	terminal block Phoenix SPT_2.5/3-V-5.0
Data Output	terminal block Phoenix SPTAF 1/3-3,5
Operating ambient temperature range	-20/+40°C (-4°F / +104°F)
Protection factor	CE: IP67
Weight	2.78 kg (6.13 lbs)

Dimensions

mm [inch]

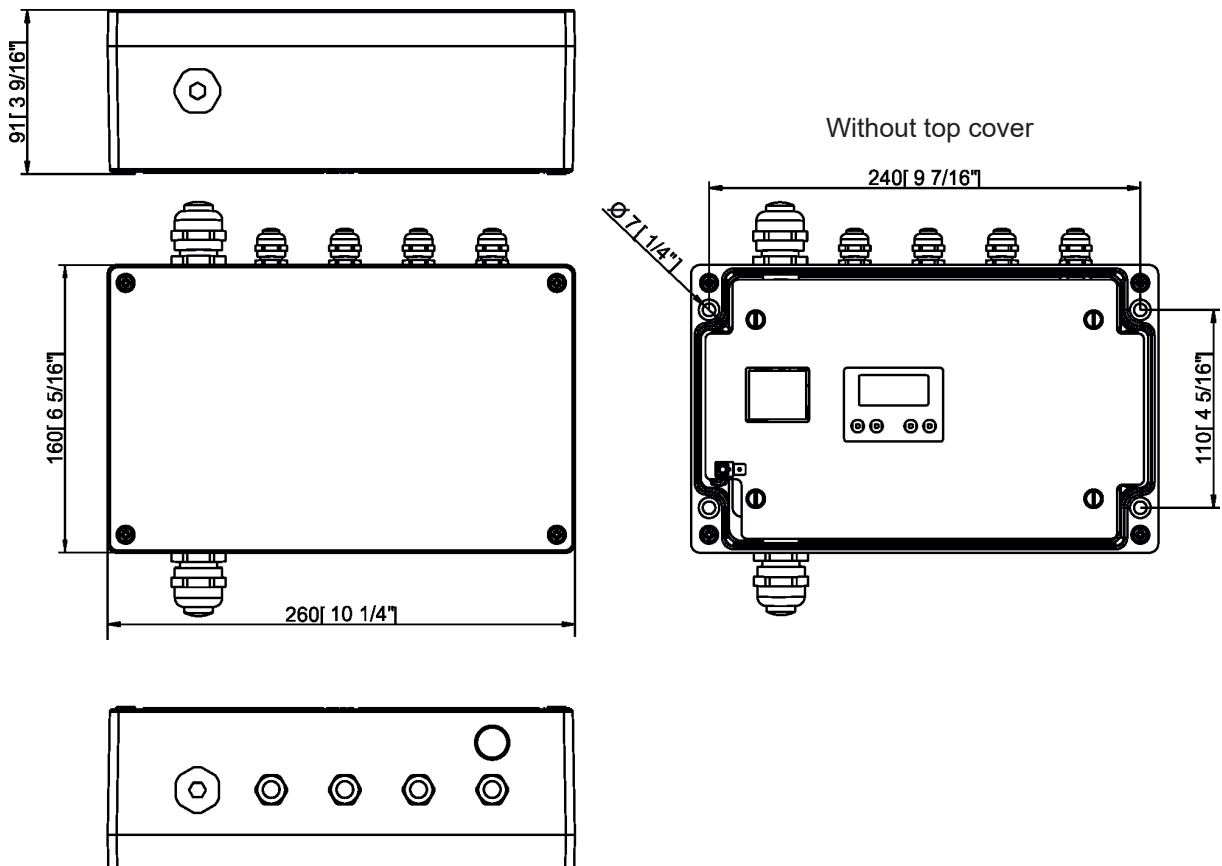

E-box Star

Number of inputs:	1
Input voltage	120-277 V AC; 50/60Hz
Power consumption	5W (self-consumption of the E-box)
Fuse	T 0.5A H
LED Outputs	
Number of outputs	6
Voltage	120-277 V each output)
Max. current	16A in total for all outputs
Warning:	In view of the fact that e E-box Star has only one power input, outputs to Emineres cannot be so loaded as outputs for Emineres at the E-box Pro.
Control	2-row LCD display & 4 buttons
Supported protocols	USITT DMX 512, ArtNet, sACN, RDM
W-DMX control (optional)	
Connection	
Power IN	terminal block Phoenix 2 SPT_2.5/3-V-5.0
Ethernet IN/OUT	terminal block Phoenix SPTAF_1/9-3.5
DMX IN/OUT	terminal block Phoenix SPTAF 1/3-3,5
LED Output	terminal block Phoenix SPT_2.5/3-V-5.0
Data Output	terminal block Phoenix SPTAF 1/3-3,5
Operating ambient temperature range:	-20/+40°C (-4°F / +104°F)
Protection factor:	CE: IP67
Weight	4.4 kg (9.7 lbs)

Dimensions
mm [inch]

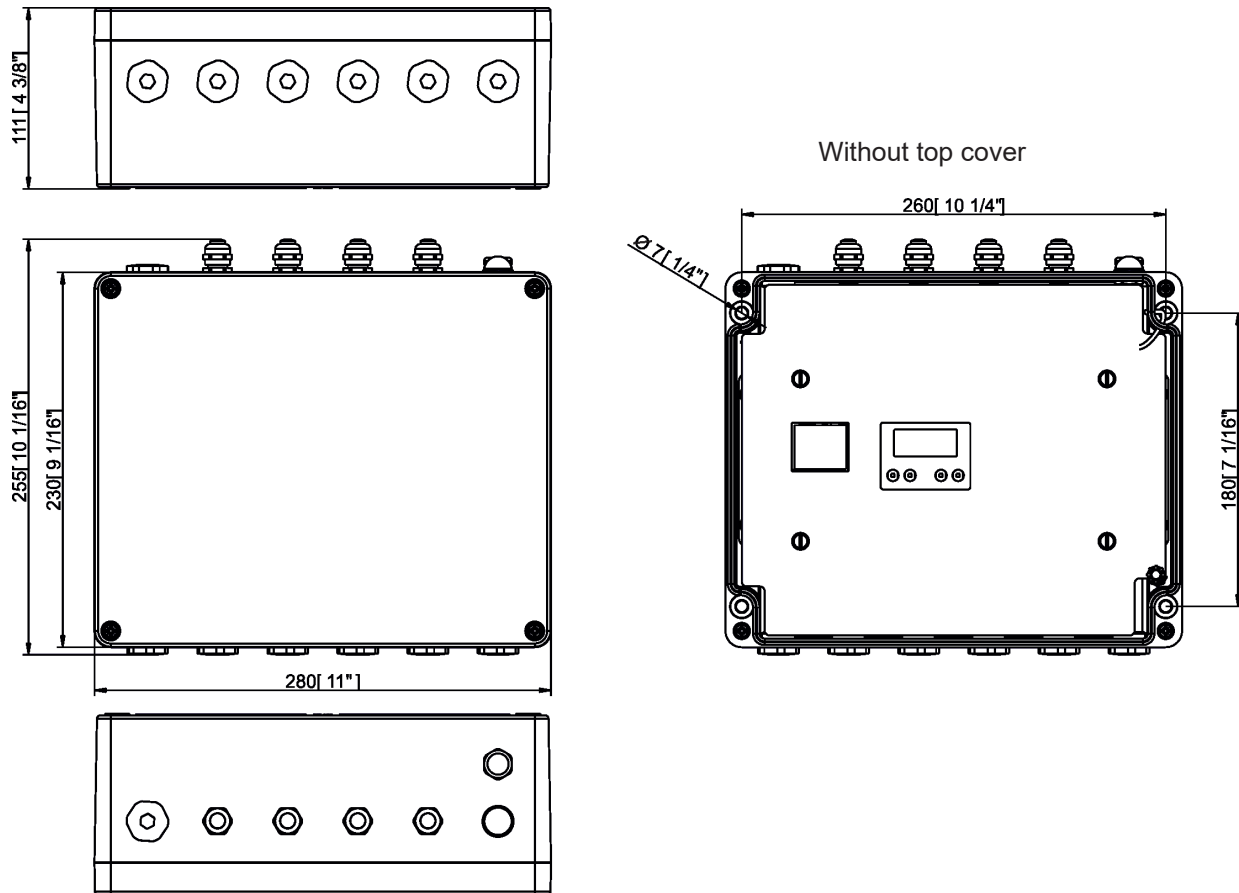

E-box Lite

Number of inputs:	1
Input voltage	120-277 V AC; 50/60Hz
Power consumption	5W (self-consumption of the E-box)
Fuse	T 0.5A H
LED Output	
Number of outputs	1
Voltage	120-277 V
Max. current	16A
Control	2-row LCD display & 4 buttons
Supported protocols	USITT DMX 512, RDM
W-DMX control (optional)	
Connection	
Power IN	terminal block Phoenix 2 SPT_2.5/3-V-5.0
DMX IN/OUT	terminal block Phoenix SPTAF 1/3-3,5
LED Output	terminal block Phoenix SPT_2.5/3-V-5.0
Data Output	terminal block Phoenix SPTAF 1/3-3,5
Operating ambient temperature range	-20/+40°C (-4°F / +104°F)
Protection factor	CE: IP67
Weight	1.67 kg (3.85 lbs)

Dimensions
mm [inch]

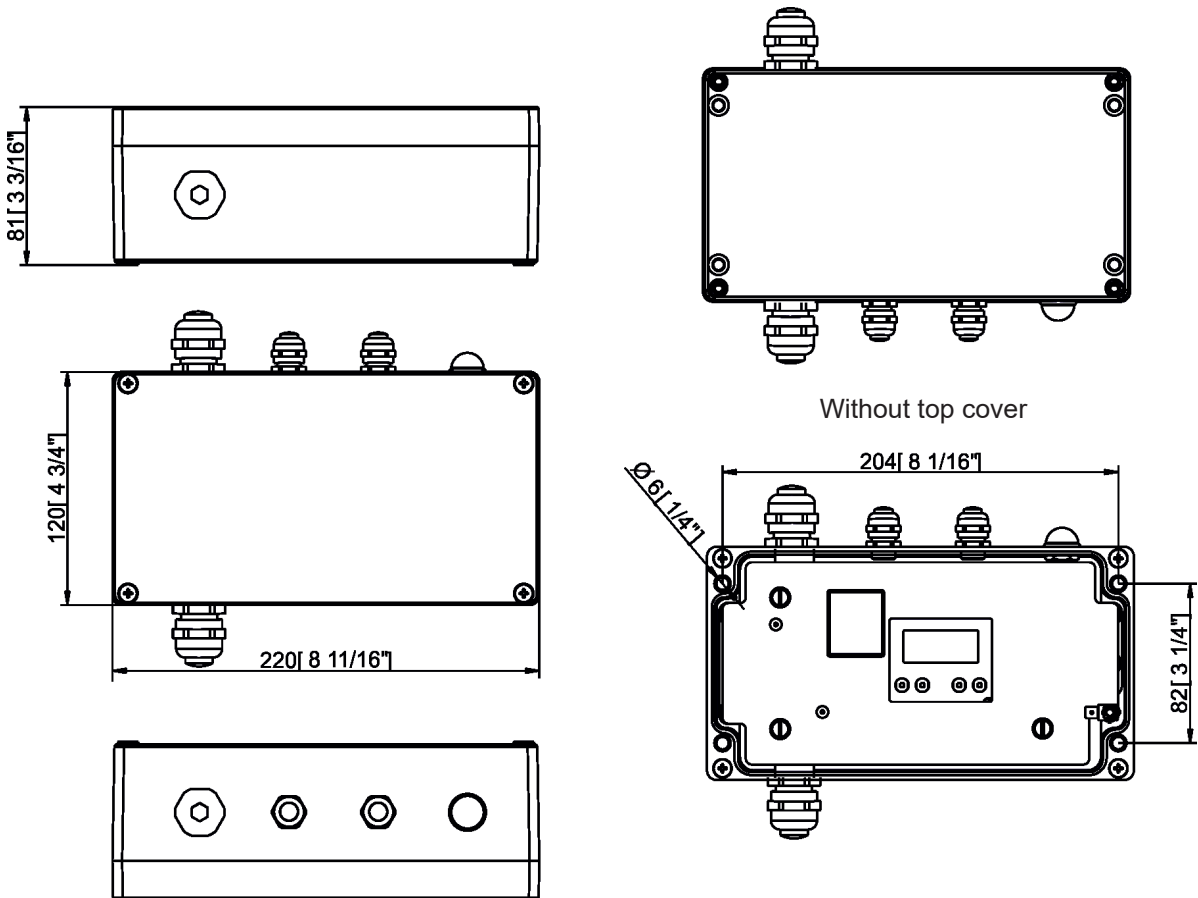

Included items

- 1 x E-box
- 1 x User manual

9. Disposing of the product

To preserve the environment please dispose or recycle this product at the end of its life according to the local regulations and codes.

10. ChangeLog

This section summarizes changes in the user manual.

Version of the manual	Date of issue	Description of changes
1.1	2/10/2019	Changes in menu Personality
1.2	17/10/2019	E-box Light added
1.3	25/11/2019	Booster box added
1.4	11/03/2020	Information about Eminere Inground added
1.5	22/04/2020	Technical specifications more specified
1.6	17/05/2020	Wiring of Emineres changed (Data +, Data -)
1.7	29/05/2020	Pass-Thr mode description added
1.8	22/06/2020	Voltage range change
1.9	25/11/2020	Menu Stand Alone added
2.0	27/05/2021	Menu item Input Data added
2.1	24/09/2021	Pass-Thru mode description changed
2.2	30/09/2021	E-box Pro removed
2.3	19/10/2021	Technical Specifications changed
2.4	08/09/2022	E-box Lite description changed

September 8, 2021

Specifications are subject to change without notice.

Copyright © 2019-2022 Robe Lighting - All rights reserved

Made in CZECH REPUBLIC by ROBE LIGHTING s.r.o. Palackeho 416/20 CZ 75701 Valasske Mezirici