

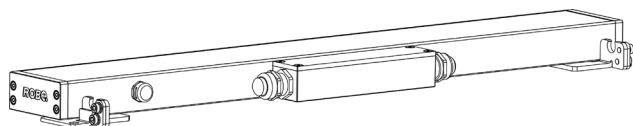

The unit must be installed by a qualified electrician in accordance with all national and local electrical and construction codes and regulations.

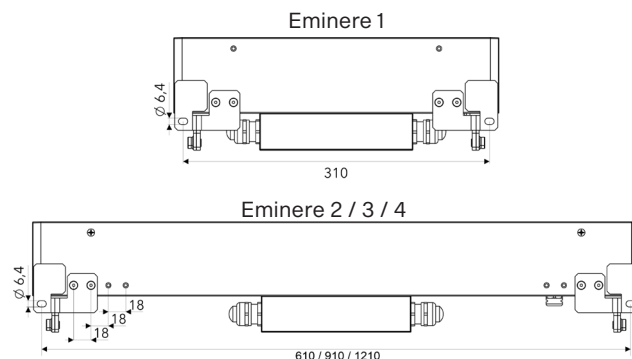

Eminere Remote with standard mounting brackets.



Brackets spacing.

**STEP 1.A
INSTALLATION WITH STANDARD MOUNTING BRACKETS**

1

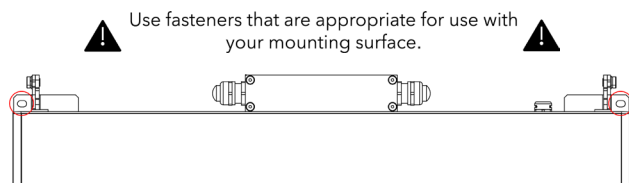

Use fasteners that are appropriate for use with your mounting surface.

The Eminere Remote can be arranged in any orientation on a flat, non-flammable surface by means of two mounting brackets. Two mounting holes can be drilled into the mounting surface according to brackets spacing and size of fasteners, prior to mounting of the fixture.

2

2X M5x10

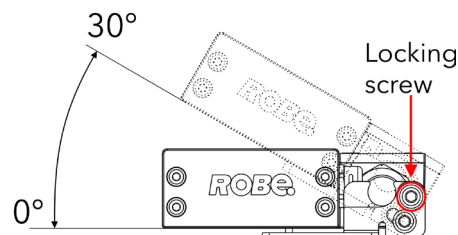

Mounting brackets can be tilted by 30°. Loosen M5x10 locking screws on both sides, adjust fixture to desired position and fasten the fixture to mounting surface (via pre-drilled holes). Tilt the luminaire into desired angle and tighten locking screws on both sides.

**STEP 2
CONNECTION**

1

4X M4x12

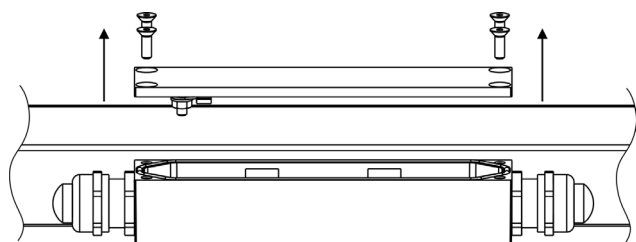

Unscrew the four screws on the cover of the junction box and remove the cover and the gasket.

2

A	
Wire Connection	8 mm

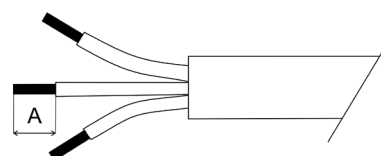

Strip these lengths for cable connections.

3 Connection – colour coding

LED Unit Connection - CE Leader

TERMINAL BLOCK	VCC	D+	D-	0V	GROUND
Colour of Wire	Black	Red	Orange	White	/

LED Unit Connection - US leader

TERMINAL BLOCK	VCC	D+	D-	0V	GROUND
Colour of Wire	Black	Red	Orange	White	Green

4 Wiring connection

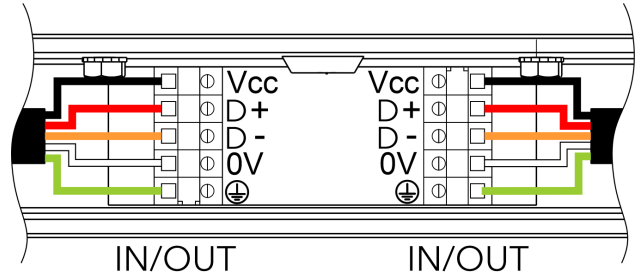
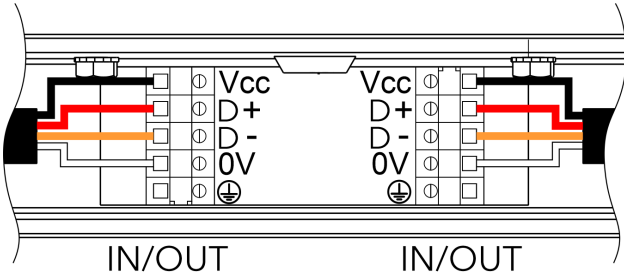

EU colour code shown

US colour code show

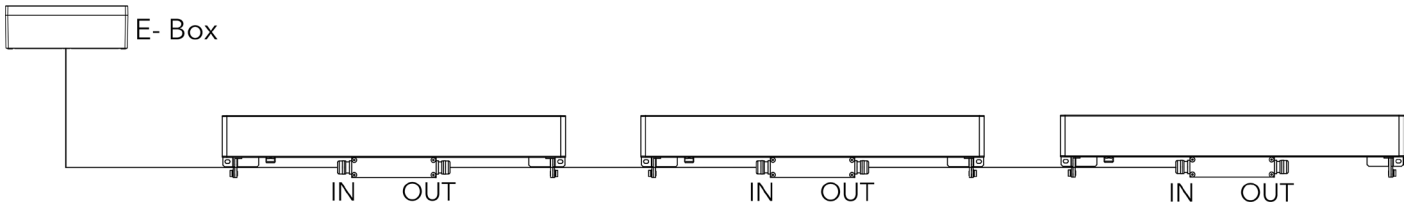

Note for E-box Remote Basic.

If the Emineres Remote are connected to the LED output of the E-box Remote Basic, the last Eminere Remote has to be terminated by a terminator. The terminator is a 120 Ohm resistor connected between terminals D+ and D- in the last fixture.

If both LED outputs of the E-box Remote Basic are used, both lines of Emineres Remote have to be terminated by the 120 Ohm resistor.

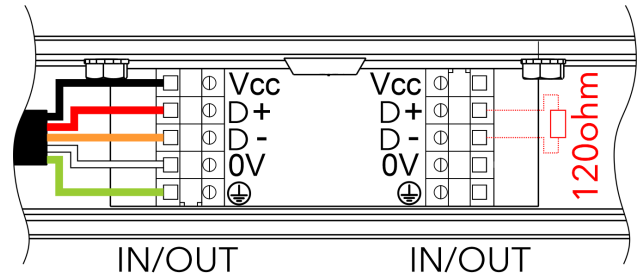

STEP 3 CABLE GLAND INSTALLATION

Use wrench size 24 for cable gland M20x1.5

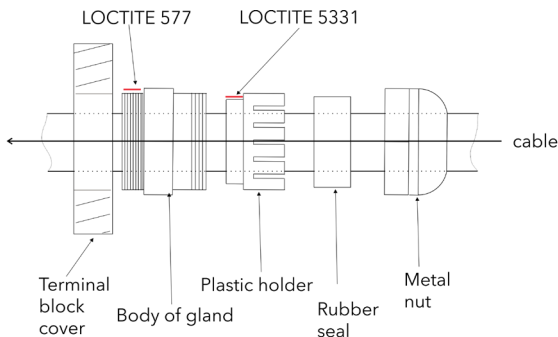

Apply Loctite 5331 thread sealant on the plastic holder and Loctite 577 thread locking compound on the gland body in the indicated locations prior to assembly.

Failure to properly install cable glands will result in failure of the water tight seal!

STEP 4 FILLING OF CONNECTION BOX WITH SYNTHETIC RESIN

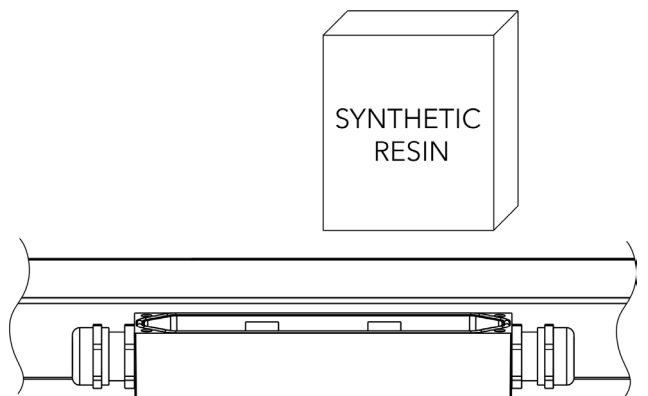

After checking all connections, fill the Connection Box with synthetic resin. Make sure that the End Cap is inserted in unused cable gland before filling it. At filling of the Connection Box proceed according instructions stated on the bag of the resin. The connection blocks have to be fully poured in the resin.

STEP 5
REASSEMBLING OF CONNECTION BOX

4X  M4x12

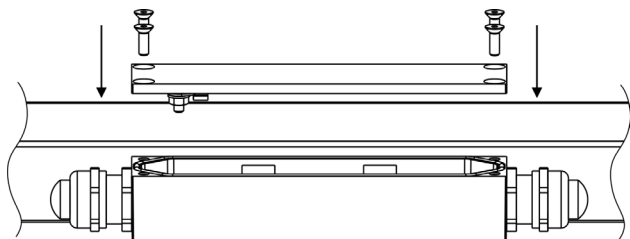

Place the gasket carefully back into the slot. Place the cover back on top of the Connection Box and fasten it with four M4x12 screws.

STEP 6
INSTALLATION OF SHIELD

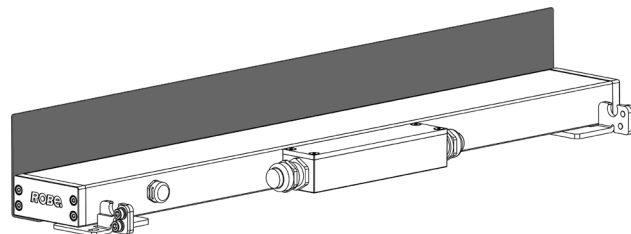

Eminere Remote with shield installed.

1

2X  M4x6

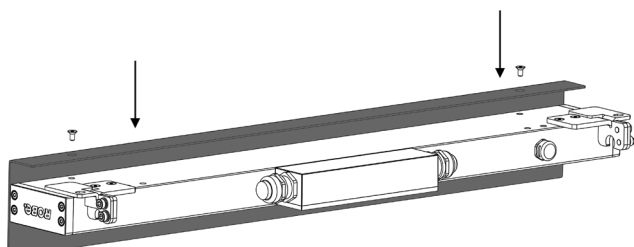

Shield must be fasten from the bottom side of the fixture by two M4x6.

